

Listino **NOTTE**  
**GENNAIO**

**25**



PIÙ IN ALTO

**ARMADI SU MISURA**

**pag. 5**

---

BOISERIE

**CABINA ARMADIO CON PANNELLI LEGNO**

**pag. 63**

---

I TUBI

**CABINA ARMADIO CON TUBI METALLICI**

**pag. 79**

---

ICON

**CABINA ARMADIO CON TELAIO ALLUMINIO**

**pag. 99**

---

ASCOT

**CABINA ARMADIO CON FIANCO LEGNO**

**pag. 113**

---

CREMA

**CABINA ARMADIO CON CREMAGLIERE**

**pag. 133**

---

## CONDIZIONI GENERALI DI VENDITA

A parziale deroga ed a completamento delle condizioni disciplinate dal Codice Civile agli art. 1740 e seguenti, si intendono note ed accettate dalle parti, le seguenti altre clausole:

a) Gli ordini si intendono assunti e comunque salvo approvazione della ZEMMA srl, che peraltro declina ogni e qualsiasi responsabilità per ritardi di consegna o per la mancata evasione degli ordini stessi e per questo non è tenuta a nessun tipo di risarcimento.

b) Le merci viaggiano a rischio e pericolo dell'acquirente anche se vendute franco destino.

c) Per consegne con importi inferiori a Euro 901 il trasporto sarà a carico del destinatario.

d) Eventuali reclami sulla merce devono essere segnalati già in sede di consegna con annotazioni sul documento di trasporto o massimo entro otto giorni dal ricevimento della fornitura a mezzo lettera raccomandata. Trascorso tale termine, la ZEMMA srl avrà la facoltà di respingere ogni e qualsiasi addebito in ordine a vizi o difetti della merce.

e) È facoltà della ZEMMA srl, a proprio insindacabile giudizio, apportare in qualsiasi momento e senza preavviso, tutte le variazioni che riterrà necessarie anche se di carattere sostanziale, alle caratteristiche tecniche, costruttive o di design dei propri modelli nonché ai prezzi nel presente listino.

Si declina inoltre ogni responsabilità per eventuali errori tipografici nel listino stesso o d'impostazioni.

f) Fermo restando quanto esposto al punto "e", le caratteristiche tecniche del prodotto sono quelle contenute nel presente listino.

Qualsiasi informazione rilasciata da agenti o collaboratori è da ritenersi priva di veridicità se non trova riscontro nel presente listino e se non viene successivamente confermata per iscritto dal Ns. Ufficio Tecnico.

La Zemmasrl declina qualsiasi responsabilità per informazioni errate o inesatte fornite da agenti o collaboratori, o per cattiva interpretazione del listino, motivi che non possono essere oggetto di contestazione.

g) Non si accettano restituzioni di merce se non concordate ed autorizzate preventivamente.

In ogni caso la merce resa verrà accreditata al prezzo di acquisto originario con una deduzione pari al 30% relativamente al trasporto, imballo, ripristino, ecc. Se la merce stessa dovesse essere resa non in perfetto stato, la valutazione dell'accredito corrisponderà al valore eventualmente recuperabile.

h) Per la merce non ritirata, la ZEMMA srl potrà esigere il pagamento dei danni derivanti.

i) Qualsiasi deroga alle condizioni di vendita dovrà essere preventivamente concordata per iscritto con la Casa né il silenzio potrà essere considerato quale tacito consenso all'eccezione.

l) Qualora l'acquirente non rispetti le condizioni di pagamento convenute è facoltà della ZEMMA srl, di recedere da contratti ancora in corso, oppure di sospendere la consegna della merce di tutti gli ordini ancora da evadere o evaderli esclusivamente per contrassegno.

m) Per tutte le controversie che dovessero sorgere nei rapporti tra i contraenti, unico Foro competente a decidere è designato quello di Como.

### **- I prezzi si intendono I.V.A. ESCLUSA.**

**Sono esclusi eventuali spese di trasporto, montaggio e progettazione da riconoscere al venditore.**

- Il presente listino annulla e sostituisce a tutti gli effetti i listini precedenti.

**IMPORTANTE:  
Non è possibile annullare o modificare gli ordini già trasmessi.**

## CONDIZIONI GENERALI DI VENDITA

Per un corretto sviluppo dell'ordine, si consiglia di fornire le quote come indicato negli schemi.

LA ZEMMA SRL DECLINA QUALSIASI RESPONSABILITÀ PER QUOTE ERRATE.

**IMPORTANTE: VERIFICARE LA TENUTA DI SOFFITTO E PARETI.  
INDICARE LA PRESENZA DI ZOCCOLINI O BATTISCOPA.  
IN PRESENZA DI PRESE ELETTRICHE ED INTERRUTTORI, LE LAVORAZIONI  
DOVRANNO ESSERE EFFETTUATE SUL POSTO.**

RILEVARE L'ALTEZZA IN PIÙ PUNTI

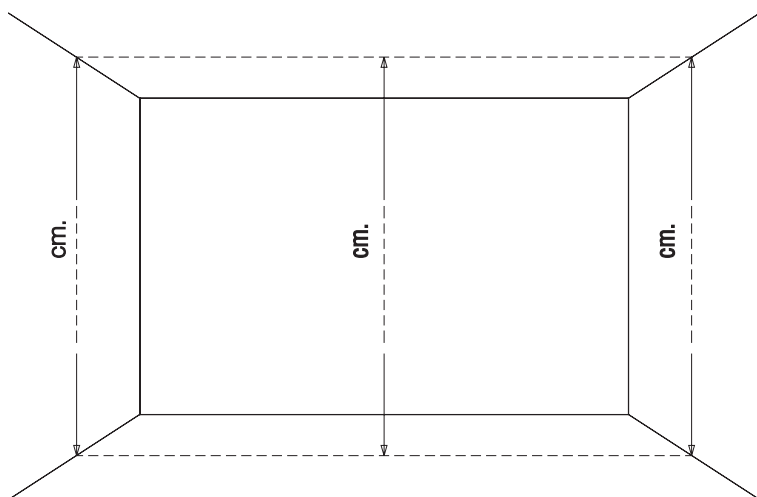

RILEVARE LA LARGHEZZA IN PIÙ PUNTI

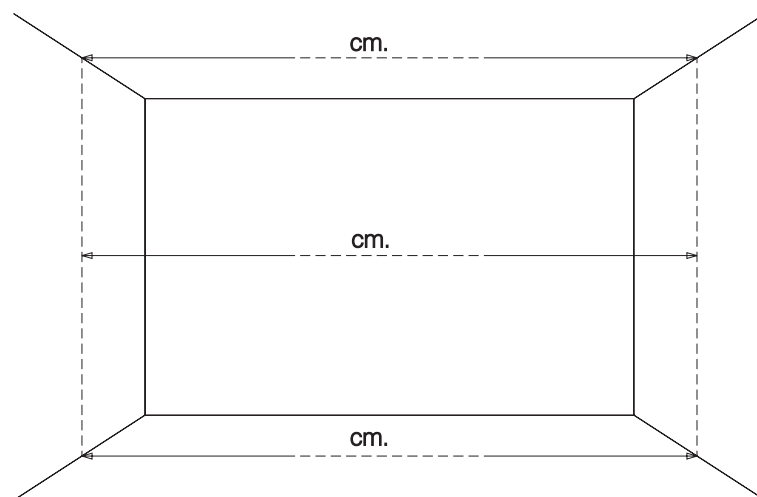

RILEVARE L'ALTEZZA E LA LARGHEZZA INDICANDO I GRADI DI INCLINAZIONE.  
FORNIRE UNA DIMA IN COMPENSATO.

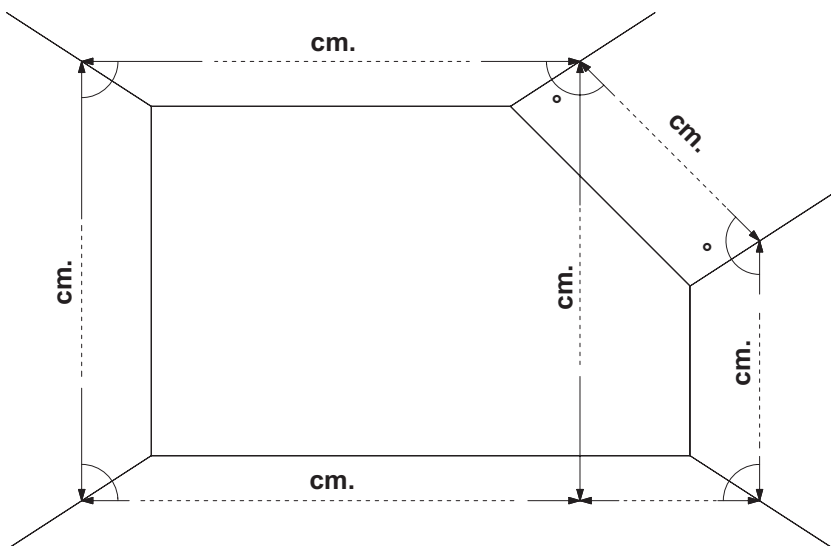

IMPORTANTE: VERIFICARE LE PENDENZE

**IMPORTANTE: NELL'ANGOLO NON É POSSIBILE INSERIRE CASSETTIERE E APPENDIABILI SALISCENDI.  
I RIPIANI AD ANGOLO SONO PREVISTI UNICAMENTE CON TAGLIO A 45°.  
IN PRESENZA DI PORTE SCORREVOLI, VERIFICARE CHE IN CORRISPONDENZA DI  
CASSETTI, RIPIANI ESTRAIBILI E APPENDIABILI SALISCENDI, L'APERTURA DELLE PORTE  
NON OSTRUISCA L'ESTRAZIONE DI TALI ELEMENTI.**

## PIÙ IN ALTO

Il programma di strutture armadio PIÙ IN ALTO è costituito da spalle, ripiani, schienali e varie attrezzature quali canne appendiabiti, cassettiere, ripiani estraibili ecc.

Le strutture armadio sono realizzate sempre su misura sia in altezza che in larghezza.

Le strutture armadio devono essere completate con le porte scorrevoli FLOOR montate fra i due fianchi laterali con binario superiore a due vie fissato a soffitto e binario inferiore su cui scorrono le ruote della porta.

Il binario inferiore viene fissato con biadesivo, senza dover forare il pavimento.

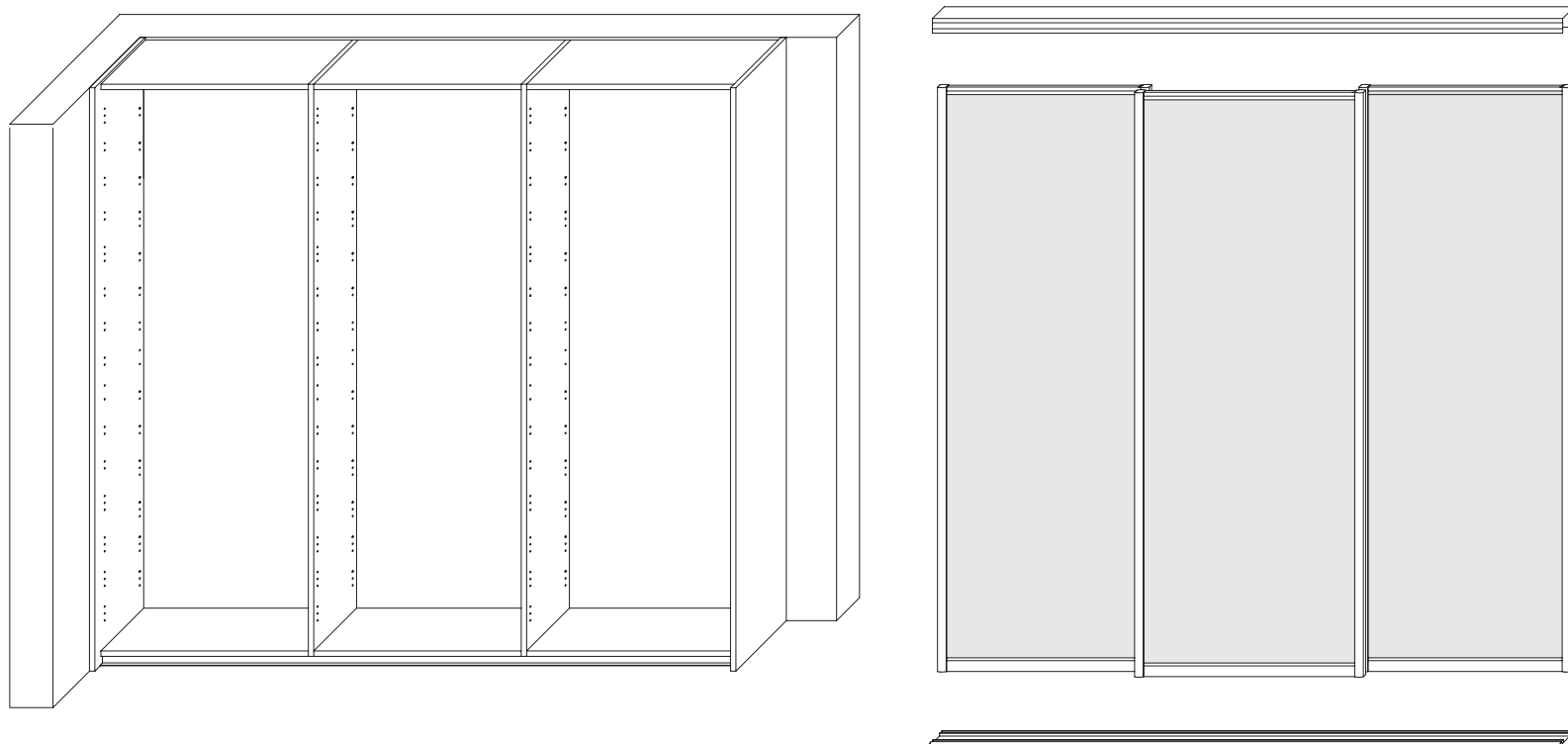

### FINITURE STRUTTURA INTERNA:

- Nobilitato bianco
- Nobilitato grigio tessuto
- Nobilitato canapa tessuto
- Nobilitato larice bianco
- Nobilitato larice termo
- Nobilitato olmo urbano

A richiesta, la struttura e le attrezzature interne possono essere fornite in finitura laccato opaco scala RAL, NCS, al campione.

Contattare il Ns. Ufficio Tecnico per specifiche tecniche e preventivi.

### FINITURE STRUTTURA ESTERNA (fianchi laterali):

- Nobilitato bianco
- Nobilitato grigio tessuto
- Nobilitato canapa tessuto
- Nobilitato larice bianco
- Nobilitato larice termo
- Nobilitato olmo urbano
- Laccato opaco scala RAL, NCS, al campione

# PIÙ IN ALTO

Le strutture armadio sono sempre realizzate su misura, riconducibili a tre fasce di prezzo.

## ALTEZZA MODULO

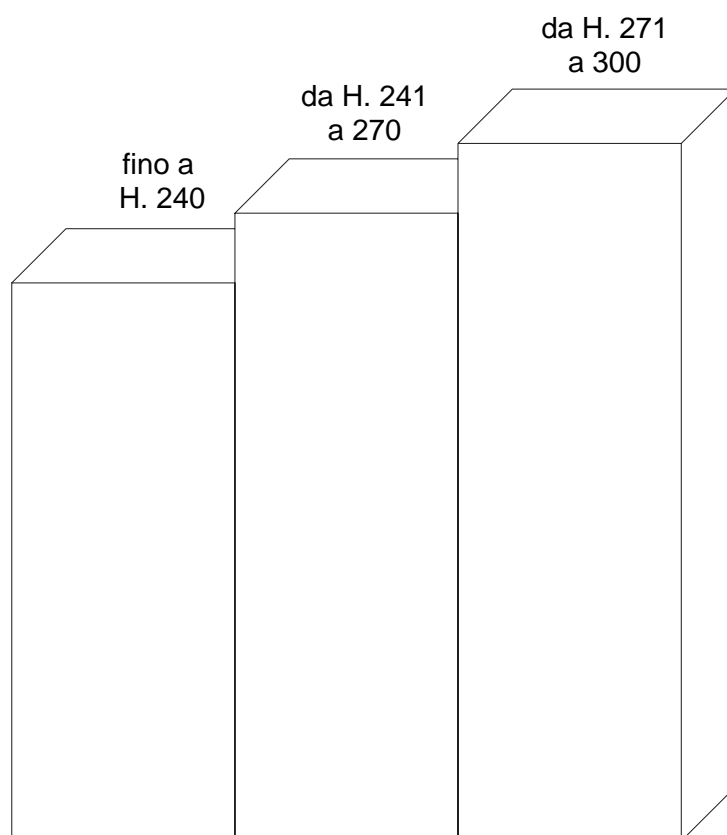

## LARGHEZZA MODULO

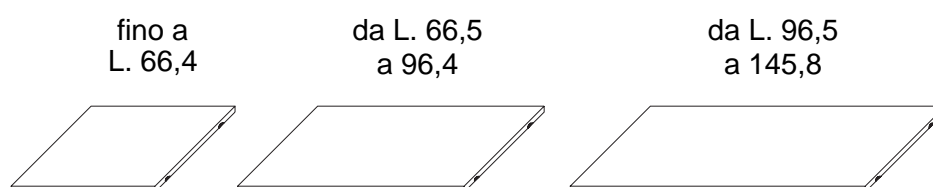

## PROFONDITÀ

La profondità della struttura armadio è di cm. 58.

La profondità del fianco laterale varia in funzione del profilo delle porte scorrevoli da abbinare: cm. 64,4 - 66,4 - 68 - 72,7.

Il fianco laterale è disponibile in profondità fino a cm. 120. Contattare il Nostro Ufficio Tecnico per specifiche tecniche e preventivi.

FIANCHI LATERALI P. 64,4  
PER PORTE PROFILO 26

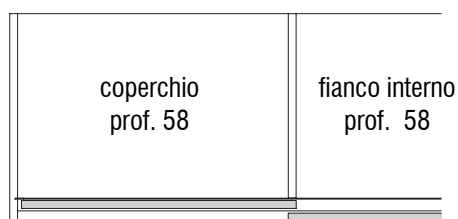

binario 2 vie FLOOR 26

FIANCHI LATERALI P. 66,4  
PER PORTE PROFILO 34

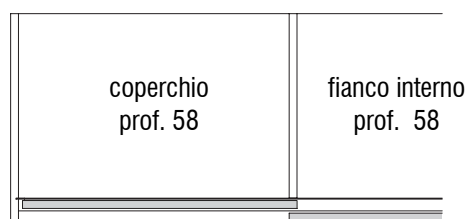

binario 2 vie FLOOR 34

FIANCHI LATERALI P. 68  
PER PORTE PROFILO 42

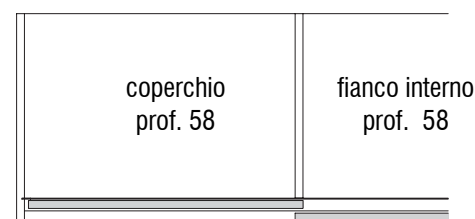

binario 2 vie FLOOR 42

FIANCHI LATERALI P. 70,3  
PER PORTE PROFILO 34

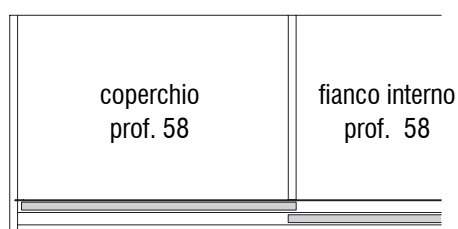

binario 3 vie FLOOR 34

FIANCHI LATERALI P. 72,7  
PER PORTE PROFILO 42

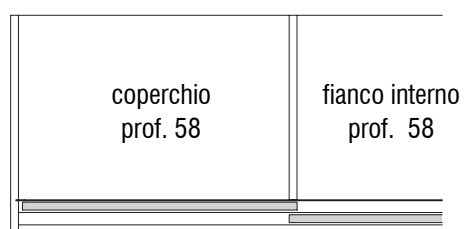

binario 3 vie FLOOR 42

FIANCHI LATERALI P. 72,7  
PER PORTE PROFILO 42:  
BASIC, MINIMAL  
CON PANNELLO TV

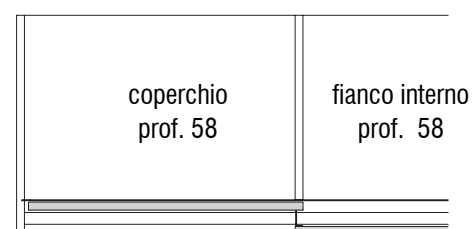

binario 3 vie FLOOR 42

## FIANCHI INTERNI

I fianchi interni sono forati per il posizionamento delle attrezzature.

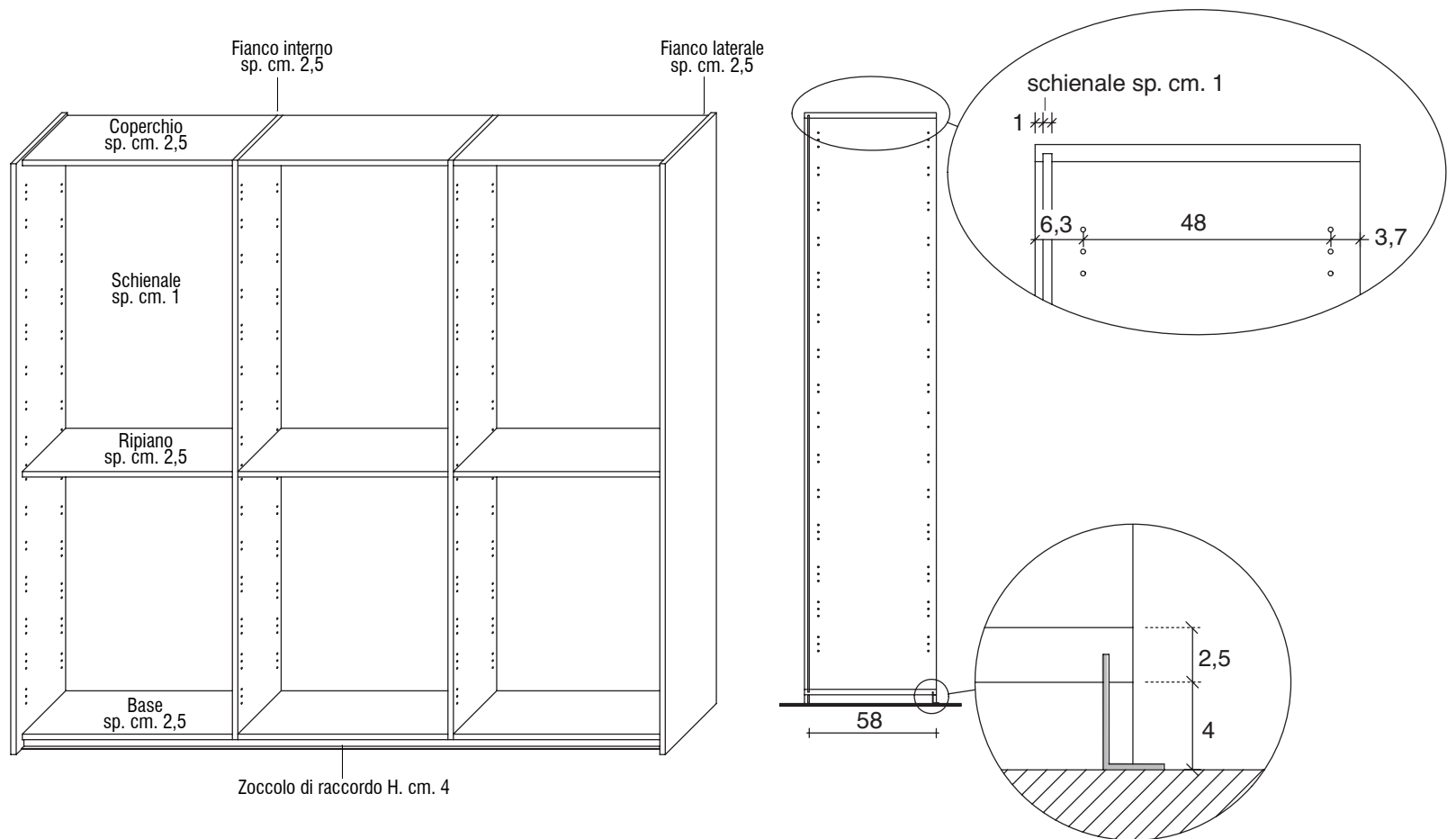

## FIANCHI LATERALI

I fianchi laterali sono forati internamente per il posizionamento delle attrezzature e sono dotati di un profilo in alluminio parapolvere.

Per ovviare alle imperfezioni delle pareti e per agevolare il montaggio della struttura armadio, i fianchi laterali vengono realizzati cm. 1,5 più bassi rispetto all'altezza pavimento/soffitto.

Tale differenza viene mascherata con accessori telescopici in dotazione.

Il fianco laterale in finitura laccato viene sempre laccato su due lati (esterno ed interno).

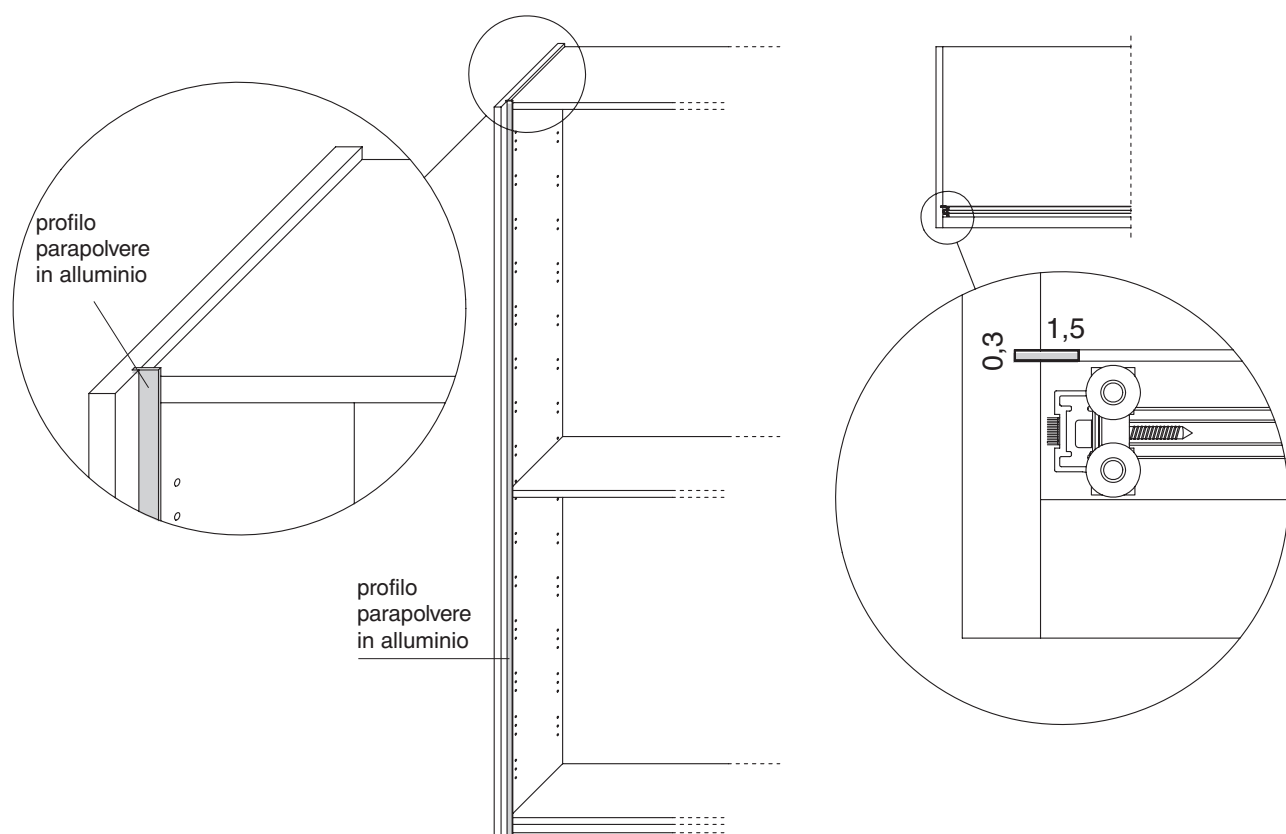



---

## PIÙ IN ALTO

---

Ove non sia possibile arrivare a soffitto, la struttura armadio viene dotata di un cappello sp. cm. 2,5, con la stessa profondità e finitura dei fianchi laterali, su cui fissare il binario superiore delle porte scorrevoli.

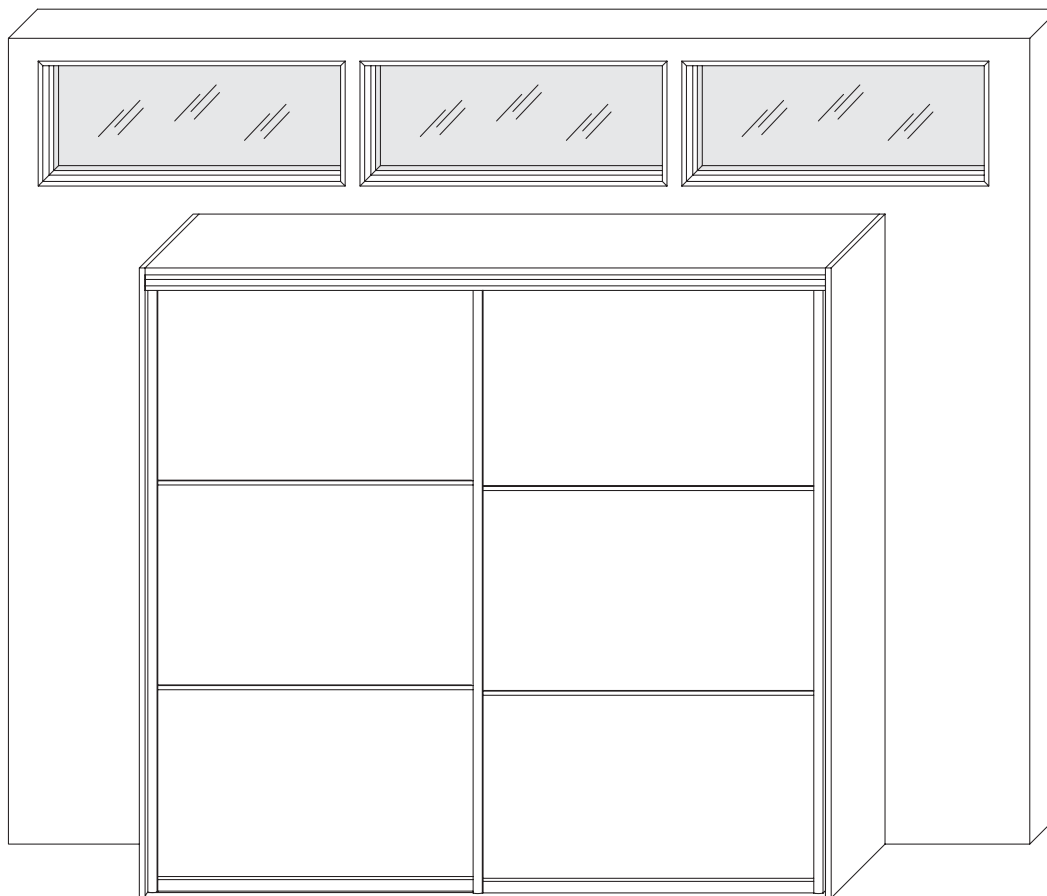

È possibile collocare l'armadio PIÙ IN ALTO anche a centro stanza.  
In tal caso l'armadio sarà dotato di superschienali sp. cm. 1,8. e la profondità varierà di cm. 2.  
Contattare il Ns. Ufficio Tecnico per specifiche tecniche e preventivi.

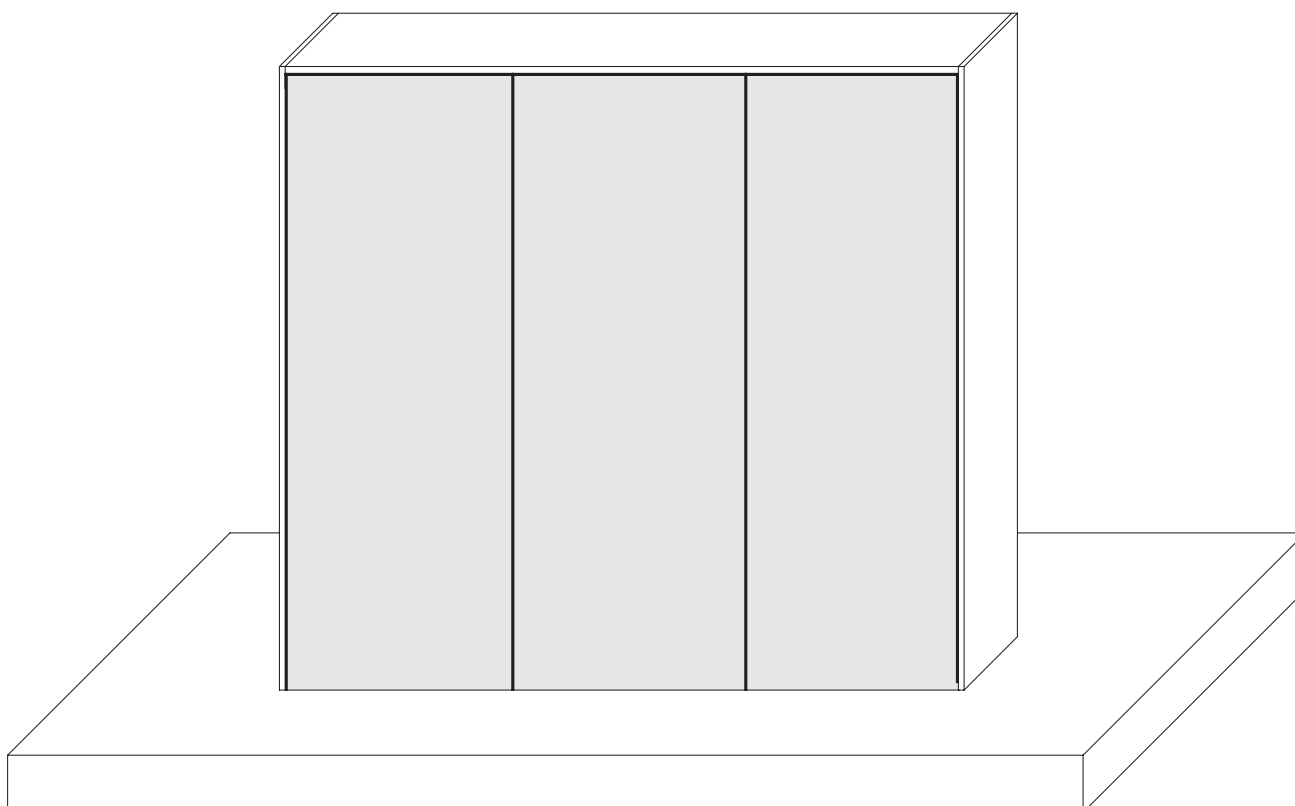

## PIÙ IN ALTO

E' possibile collocare l'armadio PIU' IN ALTO anche in nicchia, usando nelle colonne laterale una speciale giunzione con molla.

E' comunque necessario calcolare in fase di progettazione cm 1.5 di spazio tecnico per lato, per poter infilare i fianchi esterni.

Il rilievo delle misure deve essere effettuato tenendo in considerazione la presenza di eventuali zoccolini.

E' possibile sigillare completamente l'armadio fra i muri mettendo 2 battute laterali , che a porte aperte chiudano lo spazio di 1.5 cm necessario al montaggio.

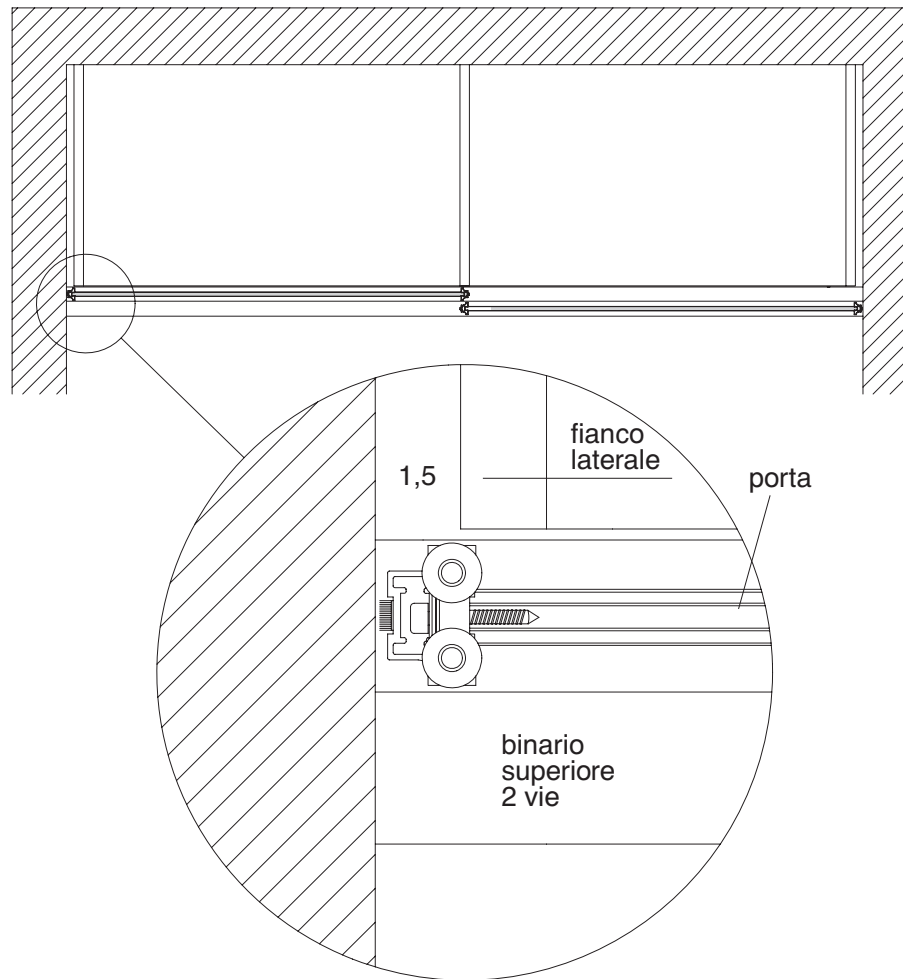

Struttura armadio con due lati liberi

**1**

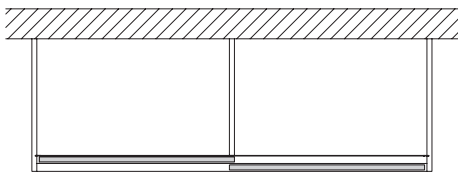

Struttura armadio con parete laterale e lato libero

**2**

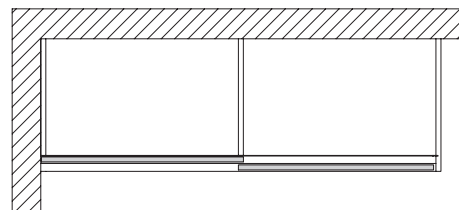

Struttura armadio in nicchia (cm. 3 necessari per il montaggio)

**3**

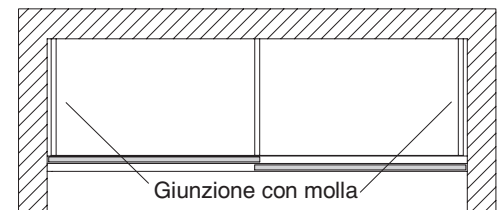

## PIÙ IN ALTO

Le strutture armadio sono sempre realizzate su misura.

Ad uno o a due moduli corrisponde una porta scorrevole.

In fase di progettazione è possibile stabilire la larghezza dei moduli, tenendo in considerazione l'aspetto funzionale ed il fattore estetico.

ESEMPIO PARETE L. cm. 275,5

Struttura armadio L. 275,5 - P. 66,4 / 68

2 Moduli L. 96,4

1 Modulo L. 72,7

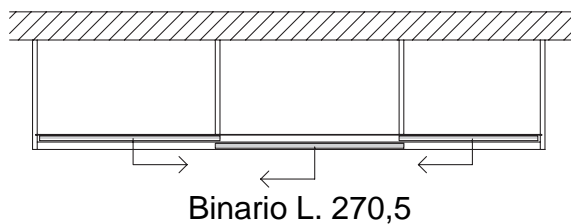

Binario L. 270,5

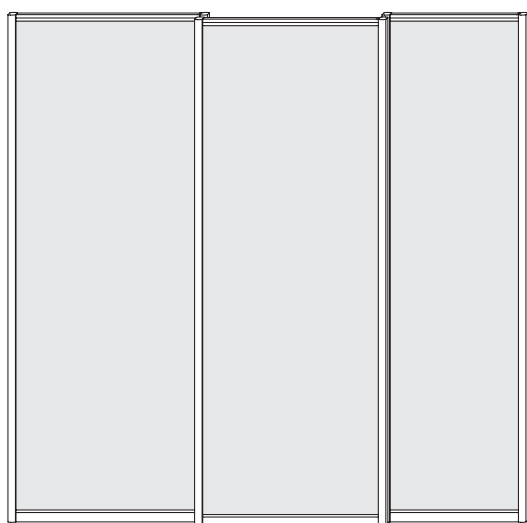
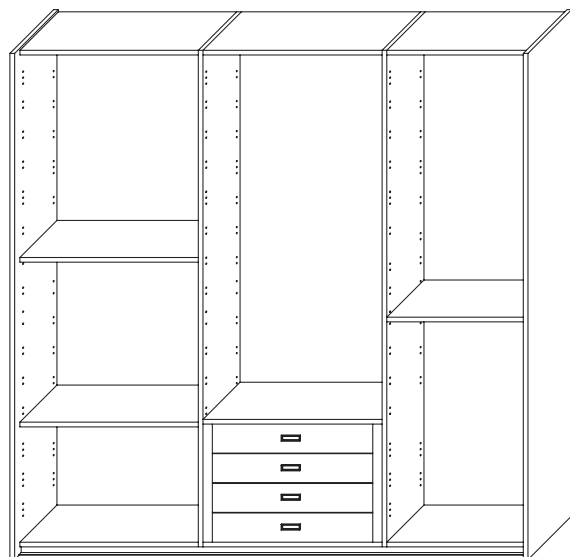

### ASPETTO FUNZIONALE:

Sono stati utilizzati 2 moduli L. 96,4 e 1 modulo L. 72,7 per poter inserire attrezzature estraibili non riducibili, a cui corrispondono 2 porte scorrevoli della stessa larghezza e una più stretta.

ESEMPIO PARETE L. cm. 275,5

Struttura armadio L. 275,5 - P. 66,4 / 68

3 Moduli L. 88,5

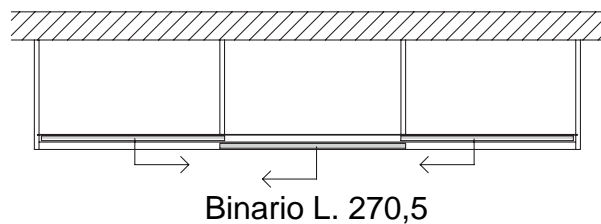

Binario L. 270,5

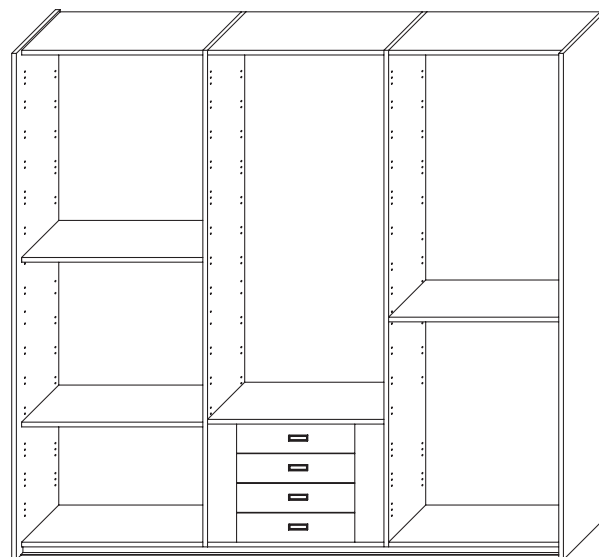

### ASPETTO ESTETICO:

Sono stati utilizzati 3 moduli uguali L. 88,5 rinunciando alle attrezzature non riducibili, a cui corrispondono 3 porte scorrevoli della stessa larghezza.

Le porte scorrevoli vengono fornite con il senso di apertura indicato negli schemi.

Per determinare il prezzo delle porte scorrevoli considerare:

- L'altezza pavimento/soffitto
- La larghezza dei moduli della struttura armadio

## PIÙ IN ALTO

Le strutture armadio sono sempre realizzate su misura.

Ad uno o a due moduli corrisponde una porta scorrevole.

In fase di progettazione è possibile stabilire la larghezza dei moduli, tenendo in considerazione l'aspetto funzionale ed il fattore estetico.

ESEMPIO PARETE L. cm. 275,5

Struttura armadio L. 275,5 - P. 66,4 / 68

1 Modulo L. 134

1 Modulo L. 65,1

1 Modulo L. 66,4

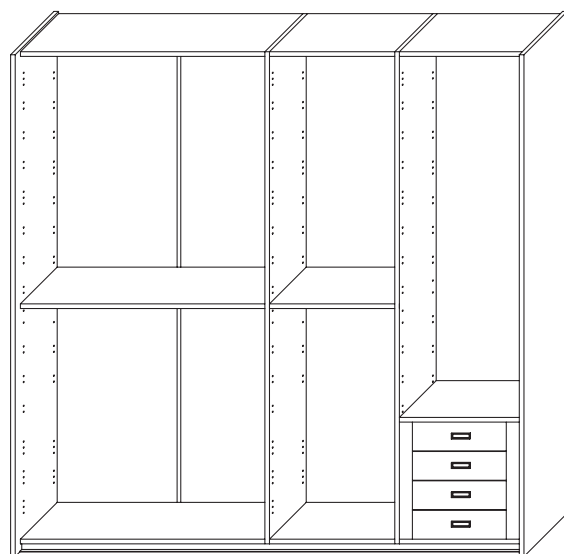
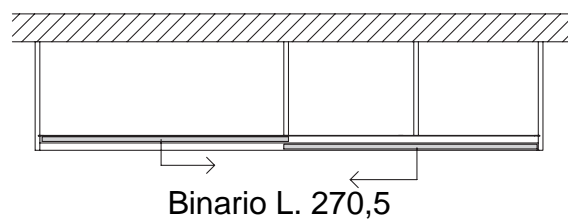

Sono stati utilizzati 1 modulo L. 134, 1 modulo L. 65,1 e 1 modulo L. 66,4 salvaguardando l'aspetto funzionale ed il fattore estetico con 2 porte scorrevoli MAXI FLOOR.

Le porte scorrevoli vengono fornite con il senso di apertura indicato negli schemi.

Per determinare il prezzo delle porte scorrevoli considerare:

- L'altezza pavimento/soffitto
- La larghezza dei moduli della struttura armadio

**DIMENSIONI STRUTTURE ARMADIO**

Se la struttura armadio è collocata in nicchia, considerare cm. 4 per lato necessari per il montaggio.

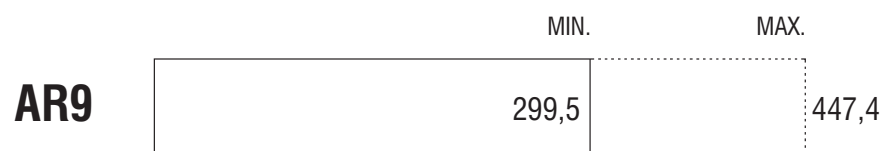
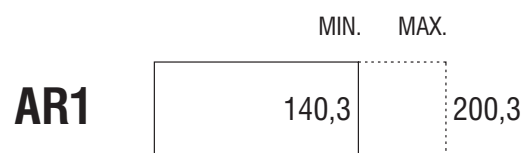

Se la struttura armadio è collocata in nicchia, considerare cm. 4 per lato necessari per il montaggio.

## AR1

Larghezza minima cm. 140,3  
Larghezza massima cm. 200,3

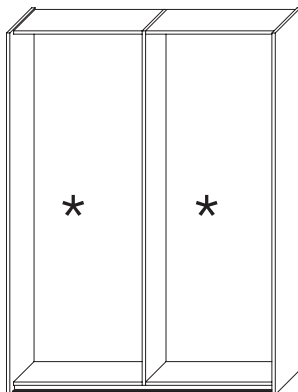

2 Moduli L. 66,4/96,4

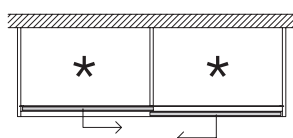

2 porte scorrevoli

- Profondità cm. 64,4 Fianchi laterali per porte profilo 26
- Profondità cm. 66,4 Fianchi laterali per porte profilo 34
- Profondità cm. 68 Fianchi laterali per porte profilo 42
- Profondità cm. 72,7 Fianchi laterali per porte profilo 42 con pannello TV  
(L. porta: min. cm. 95 - max cm. 125)

### Altezza

	fino a H. 240	da H. 241 a H. 270	da H. 271 a H. 300
Nobilitato	<b>AR1240</b> 1.156	<b>AR1270</b> 1.232	<b>AR1300</b> 1.306
Nobilitato Fianchi laterali laccato	<b>AR1240L</b> 1.396	<b>AR1270L</b> 1.516	<b>AR1300L</b> 1.637

\* Moduli riducibili

## AR2

Larghezza minima cm. 218,1  
Larghezza massima cm. 278,1

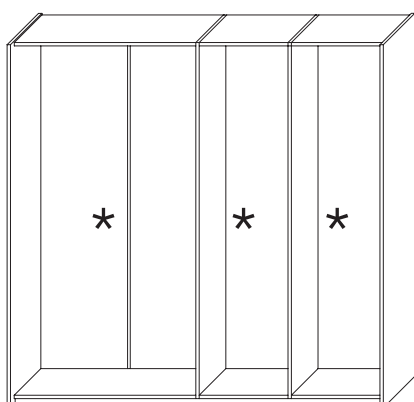

1 Modulo L. 105,3/135,3  
2 Moduli L. 51,4/66,4

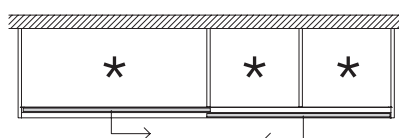

2 porte scorrevoli  
(per armadio superiore a L. 250 considerare porte MAXI FLOOR)

- Profondità cm. 64,4 Fianchi laterali per porte profilo 26
- Profondità cm. 66,4 Fianchi laterali per porte profilo 34
- Profondità cm. 68 Fianchi laterali per porte profilo 42
- Profondità cm. 72,7 Fianchi laterali per porte profilo 42 con pannello TV  
(L. porta: min. cm. 95 - max cm. 125)

### Altezza

	fino a H. 240	da H. 241 a H. 270	da H. 271 a H. 300
Nobilitato	<b>AR2240</b> 1.690	<b>AR2270</b> 1.779	<b>AR2300</b> 1.870
Nobilitato Fianchi laterali laccato	<b>AR2240L</b> 1.929	<b>AR2270L</b> 2.063	<b>AR2300L</b> 2.198

\* Moduli riducibili

Se la struttura armadio è collocata in nicchia, considerare cm. 4 per lato necessari per il montaggio.

## AR3

Larghezza minima cm. 200,5  
Larghezza massima cm. 299,1

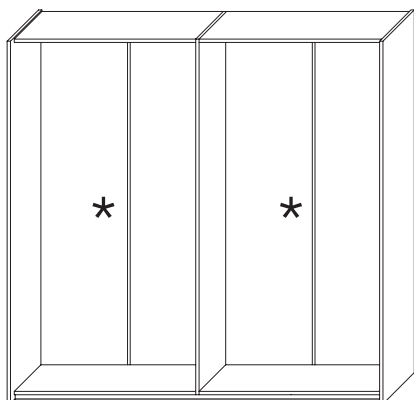

2 Moduli L. 96,5/145,8

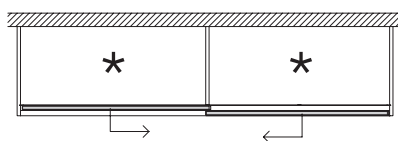

2 porte scorrevoli  
(per armadio superiore a L. 250 considerare porte MAXI FLOOR)

- Profondità cm. 64,4 Fianchi laterali per porte profilo 26
- Profondità cm. 66,4 Fianchi laterali per porte profilo 34
- Profondità cm. 68 Fianchi laterali per porte profilo 42
- Profondità cm. 72,7 Fianchi laterali per porte profilo 42 con pannello TV  
(L. porta: min. cm. 95 - max cm. 125)

### Altezza

	fino a H. 240	da H. 241 a H. 270	da H. 271 a H. 300
Nobilitato	<b>AR3240</b> 1.441	<b>AR3270</b> 1.516	<b>AR3300</b> 1.591
Nobilitato Fianchi laterali laccato	<b>AR3240L</b> 1.681	<b>AR3270L</b> 1.802	<b>AR3300L</b> 1.921

\* Moduli riducibili

## AR4

Larghezza minima cm. 209,5  
Larghezza massima cm. 299,2

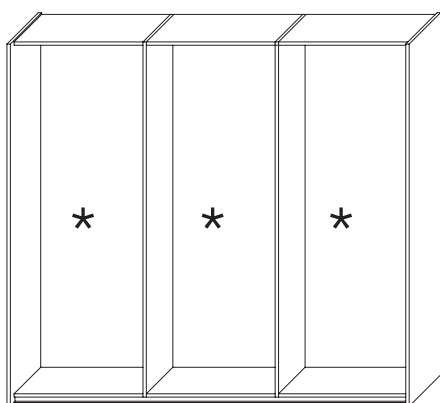

3 Moduli L. 66,5/96,4

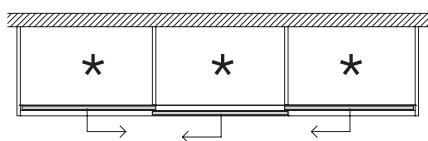

3 porte scorrevoli

- Profondità cm. 64,4 Fianchi laterali per porte profilo 26
- Profondità cm. 66,4 Fianchi laterali per porte profilo 34
- Profondità cm. 68 Fianchi laterali per porte profilo 42
- Profondità cm. 72,7 Fianchi laterali per porte profilo 42 con pannello TV  
(L. porta: min. cm. 95 - max cm. 125)

### Altezza

	fino a H. 240	da H. 241 a H. 270	da H. 271 a H. 300
Nobilitato	<b>AR4240</b> 1.606	<b>AR4270</b> 1.712	<b>AR4300</b> 1.816
Nobilitato Fianchi laterali laccato	<b>AR4240L</b> 1.846	<b>AR4270L</b> 1.995	<b>AR4300L</b> 2.146

\* Moduli riducibili

Se la struttura armadio è collocata in nicchia, considerare cm. 4 per lato necessari per il montaggio.

## AR5

Larghezza minima cm. 239,3  
Larghezza massima cm. 299,2

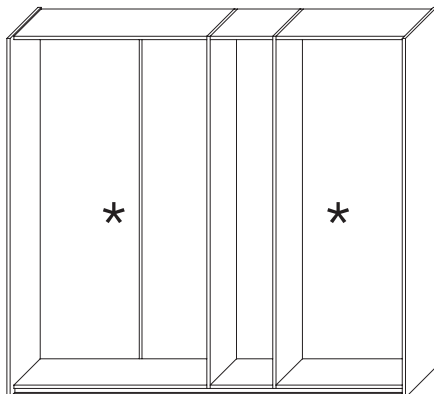

1 Modulo cm. 115,9/145,8  
1 Modulo cm. 47  
1 Modulo cm. 66,4/96,4

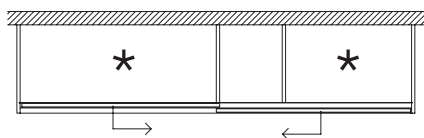

2 porte scorrevoli  
(per armadio superiore a L. 250 considerare porte MAXI FLOOR)

Profondità cm. 64,4 Fianchi laterali per porte profilo 26  
Profondità cm. 66,4 Fianchi laterali per porte profilo 34  
Profondità cm. 68 Fianchi laterali per porte profilo 42  
Profondità cm. 72,7 Fianchi laterali per porte profilo 42 con pannello TV  
(L. porta: min. cm. 95 - max cm. 125)

### Altezza

	fino a H. 240	da H. 241 a H. 270	da H. 271 a H. 300
Nobilitato	<b>AR5240</b> 1.719	<b>AR5270</b> 1.816	<b>AR5300</b> 1.914
Nobilitato Fianchi laterali laccato	<b>AR5240L</b> 1.960	<b>AR5270L</b> 2.102	<b>AR5300L</b> 2.244

\* Moduli riducibili

## AR6

Larghezza minima cm. 278,1  
Larghezza massima cm. 299,2

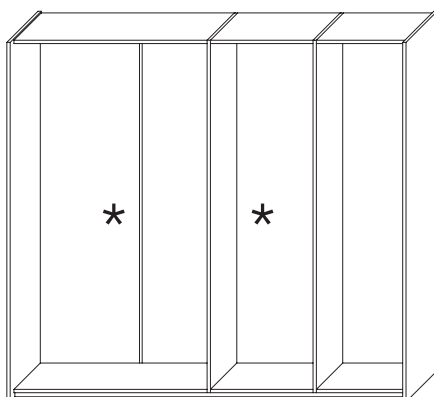

1 Modulo L. 135,3/145,8  
1 Modulo L. 66,4/77  
1 Modulo L. 66,4

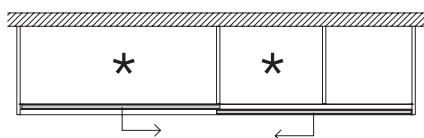

2 porte scorrevoli MAXI FLOOR

Profondità cm. 64,4 Fianchi laterali per porte profilo 26  
Profondità cm. 66,4 Fianchi laterali per porte profilo 34  
Profondità cm. 68 Fianchi laterali per porte profilo 42

### Altezza

	fino a H. 240	da H. 241 a H. 270	da H. 271 a H. 300
Nobilitato	<b>AR6240</b> 1.719	<b>AR6270</b> 1.816	<b>AR6300</b> 1.914
Nobilitato Fianchi laterali laccato	<b>AR6240L</b> 1.960	<b>AR6270L</b> 2.102	<b>AR6300L</b> 2.244

\* Moduli riducibili



# PIÙ IN ALTO

Se la struttura armadio è collocata in nicchia, considerare cm. 4 per lato necessari per il montaggio.

## AR7

Larghezza minima cm. 278,1  
Larghezza massima cm. 398,1

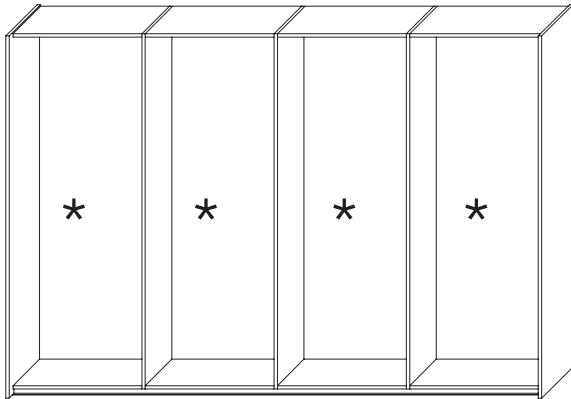

4 Moduli L. 66,4/96,4

- Profondità cm. 64,4 Fianchi laterali per porte profilo 26
- Profondità cm. 66,4 Fianchi laterali per porte profilo 34
- Profondità cm. 68 Fianchi laterali per porte profilo 42
- Profondità cm. 72,7 Fianchi laterali per porte profilo 42 con pannello TV (L. porta: min. cm. 95 - max cm. 125)

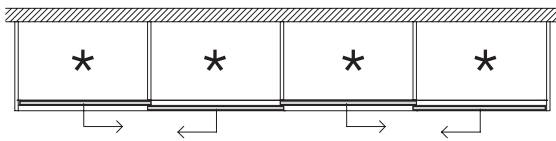

4 porte scorrevoli

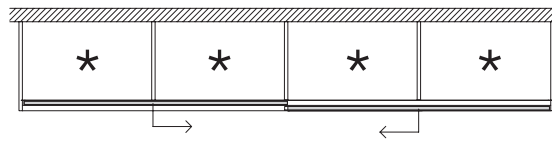

2 porte scorrevoli MAXI FLOOR

Altezza	fino a H. 240	da H. 241 a H. 270	da H. 271 a H. 300
	Nobilitato	<b>AR7240</b> 2.056	<b>AR7270</b> 2.191
Nobilitato Fianchi laterali laccato	<b>AR7240L</b> 2.295	<b>AR7270L</b> 2.475	<b>AR7300L</b> 2.654

\* Moduli riducibili

## AR8

Larghezza minima cm. 325,9  
Larghezza massima cm. 415,9

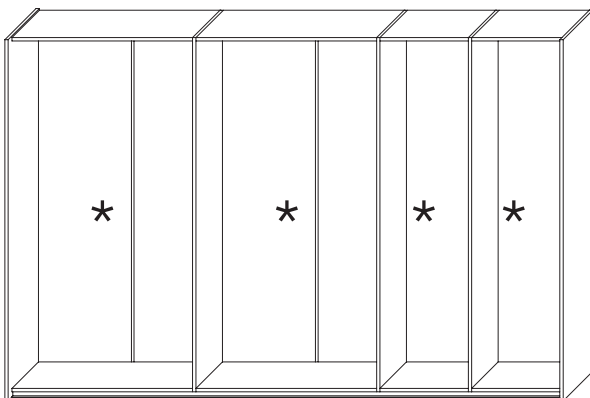

2 Moduli L. 105,3/135,3  
2 Moduli L. 51,4/66,4

- Profondità cm. 64,4 Fianchi laterali per porte profilo 26
- Profondità cm. 66,4 Fianchi laterali per porte profilo 34
- Profondità cm. 68 Fianchi laterali per porte profilo 42
- Profondità cm. 72,7 Fianchi laterali per porte profilo 42 con pannello TV (L. porta: min. cm. 95 - max cm. 125)

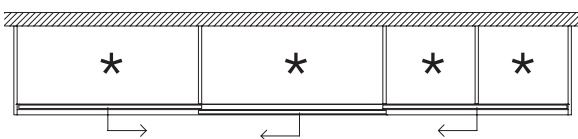

3 porte scorrevoli  
(per armadio superiore a L. 375 considerare porte MAXI FLOOR)

Altezza	fino a H. 240	da H. 241 a H. 270	da H. 271 a H. 300
	Nobilitato	<b>AR8240</b> 2.281	<b>AR8270</b> 2.400
Nobilitato Fianchi laterali laccato	<b>AR8240L</b> 2.520	<b>AR8270L</b> 2.686	<b>AR8300L</b> 2.851

\* Moduli riducibili

## PIÙ IN ALTO

Se la struttura armadio è collocata in nicchia, considerare cm. 4 per lato necessari per il montaggio.

### AR9

Larghezza minima cm. 299,5  
Larghezza massima cm. 447,4

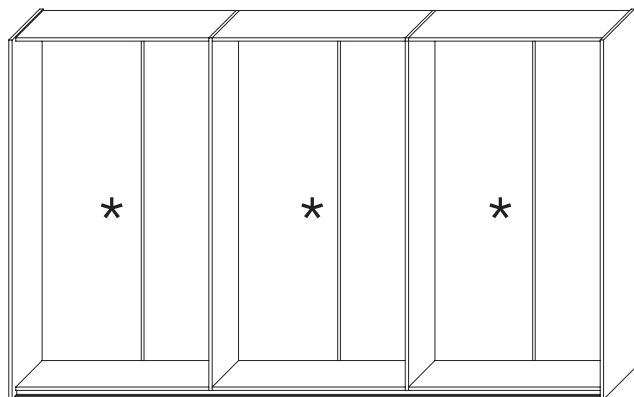

3 Moduli L. 96,5/145,8

- Profondità cm. 64,4 Fianchi laterali per porte profilo 26
- Profondità cm. 66,4 Fianchi laterali per porte profilo 34
- Profondità cm. 68 Fianchi laterali per porte profilo 42
- Profondità cm. 72,7 Fianchi laterali per porte profilo 42 con pannello TV (L. porta: min. cm. 95 - max cm. 125)

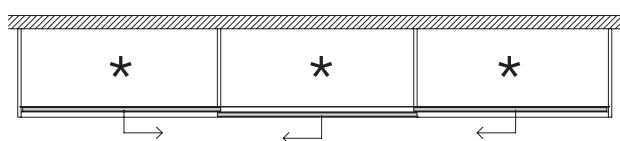

3 porte scorrevoli  
(per armadio superiore a L. 375 considerare porte MAXI FLOOR)

Altezza	fino a H. 240	da H. 241 a H. 270	da H. 271 a H. 300
	Nobilitato	<b>AR9240</b> 2.034	<b>AR9270</b> 2.139
Nobilitato Fianchi laterali laccato	<b>AR9240L</b> 2.274	<b>AR9270L</b> 2.424	<b>AR9300L</b> 2.574

\* Moduli riducibili

### AR10

Larghezza minima cm. 347  
Larghezza massima cm. 497

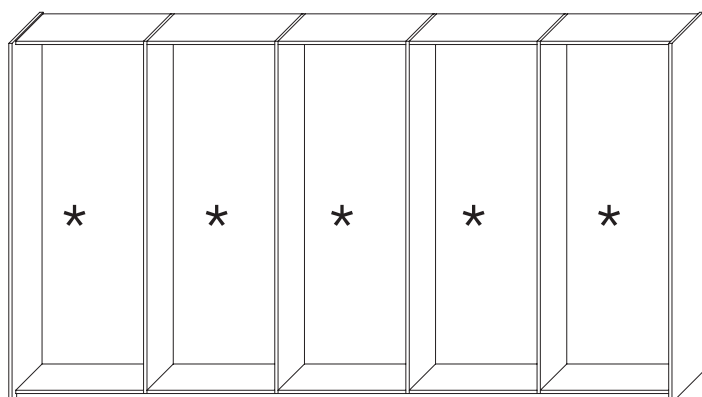

5 Moduli L. 66,4/96,4

- Profondità cm. 64,4 Fianchi laterali per porte profilo 26
- Profondità cm. 66,4 Fianchi laterali per porte profilo 34
- Profondità cm. 68 Fianchi laterali per porte profilo 42
- Profondità cm. 72,7 Fianchi laterali per porte profilo 42 con pannello TV (L. porta: min. cm. 95 - max cm. 125)

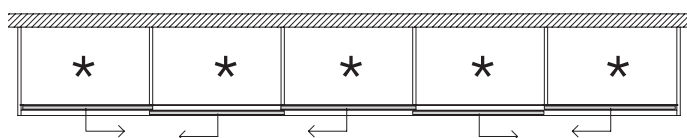

5 porte scorrevoli

Altezza	fino a H. 240	da H. 241 a H. 270	da H. 271 a H. 300
	Nobilitato	<b>AR10240</b> 2.505	<b>AR10270</b> 2.671
Nobilitato Fianchi laterali laccato	<b>AR10240L</b> 2.746	<b>AR10270L</b> 2.956	<b>AR10300L</b> 3.166

\* Moduli riducibili

## PIÙ IN ALTO

La costruzione delle strutture armadio angolari prevede uno spazio tecnico di cm. 30,5 per lato.

Struttura armadio posteriore = L. parete - cm. 30,5

Struttura armadio anteriore = L. parete - cm. 58

### ESEMPIO

PARETE A L. cm. 240,5 - cm. 30,5 = L. cm. 210 (misura della struttura armadio angolare)

PARETE B L. cm. 359,4 - cm. 30,5 = L. cm. 328,9 (misura della struttura armadio angolare)

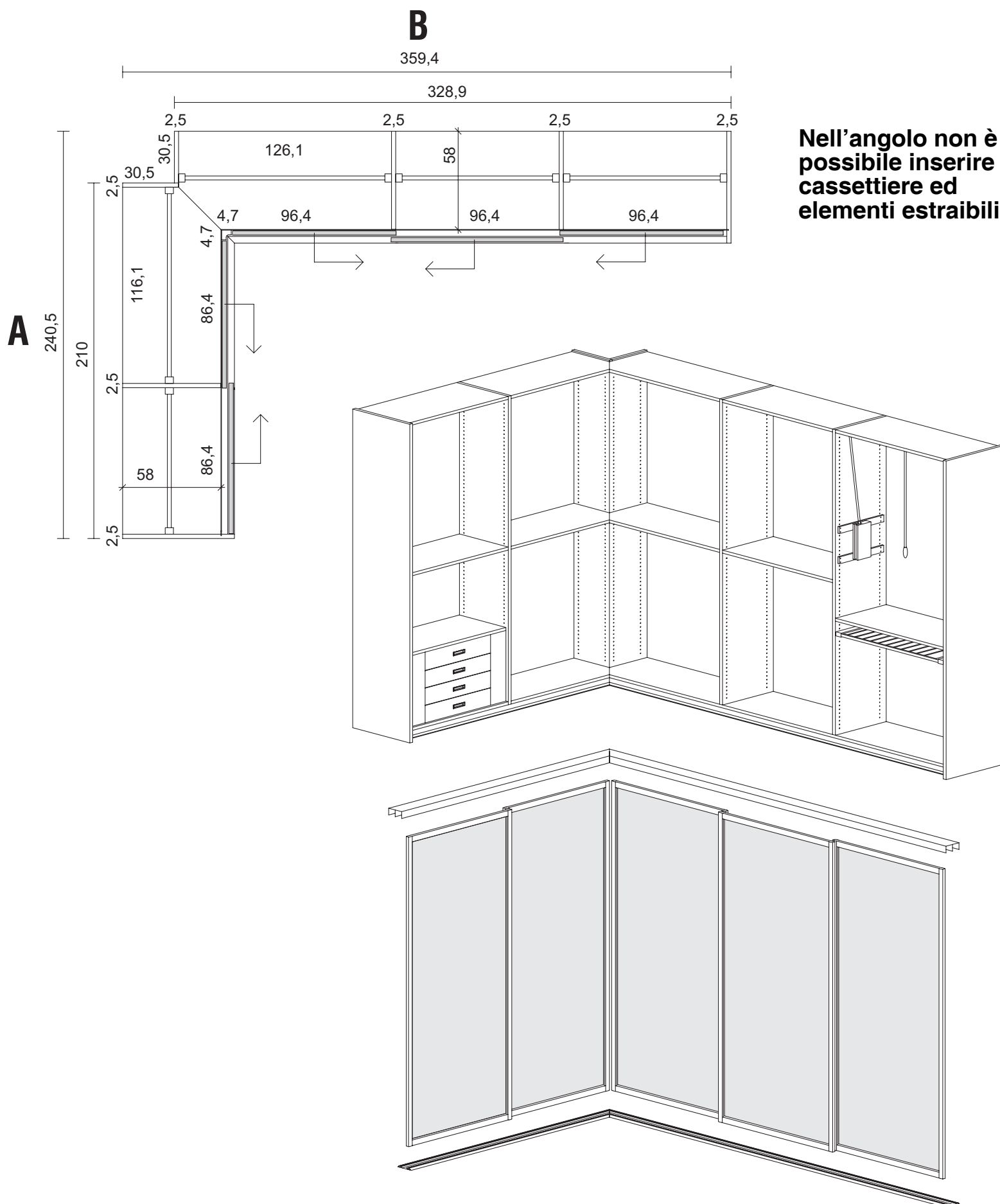

Le porte scorrevoli vengono fornite con il senso di apertura indicato negli schemi.

Per determinare il prezzo delle porte scorrevoli considerare:

- L'altezza pavimento/soffitto
- La larghezza dei moduli della struttura armadio

Le porte scorrevoli nell'angolo devono essere dotate di montante angolare in alluminio.

**DIMENSIONI STRUTTURE ARMADIO ANGOLARI**

Se la struttura armadio è collocata in nicchia, considerare cm. 4 per lato necessari per il montaggio.

PARETE L. min. cm. 221,7 - L. max. cm. 260,5

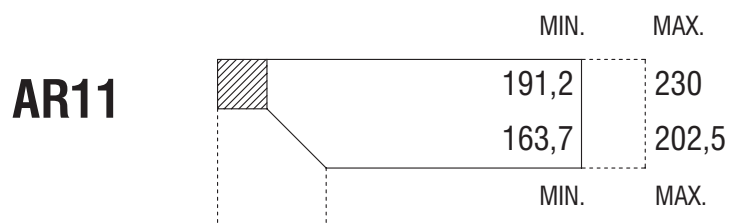

PARETE L. min. cm. 260,7 - L. max. cm. 300,9

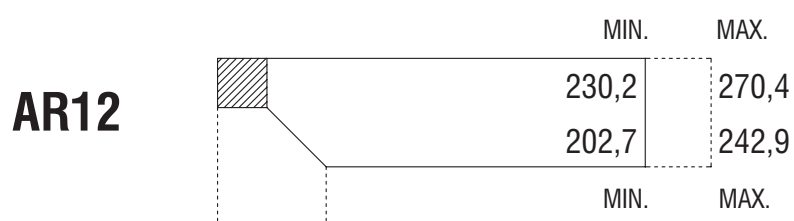

PARETE L. min. cm. 301,2 - L. max. cm. 359,4

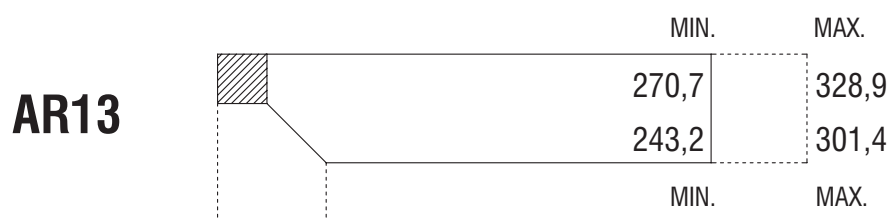

PARETE L. min. cm. 359,7 - L. max. cm. 420

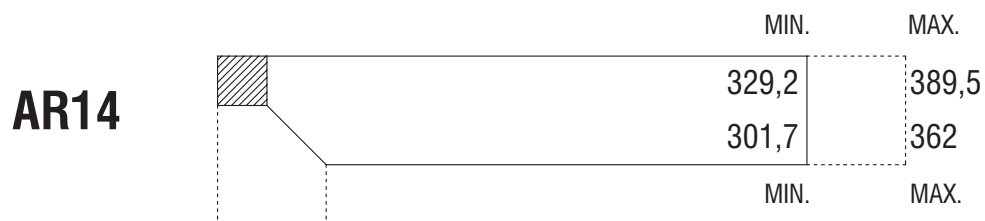

**PARETE A e PARETE B**

L. min. cm. 221,7 / L. max. cm. 300,9

**Struttura armadio posteriore**

L. min. cm. 191,2 / L. max. cm. 270,4

**Struttura armadio anteriore**

L. min. cm. 163,7 / L. max. cm. 242,9

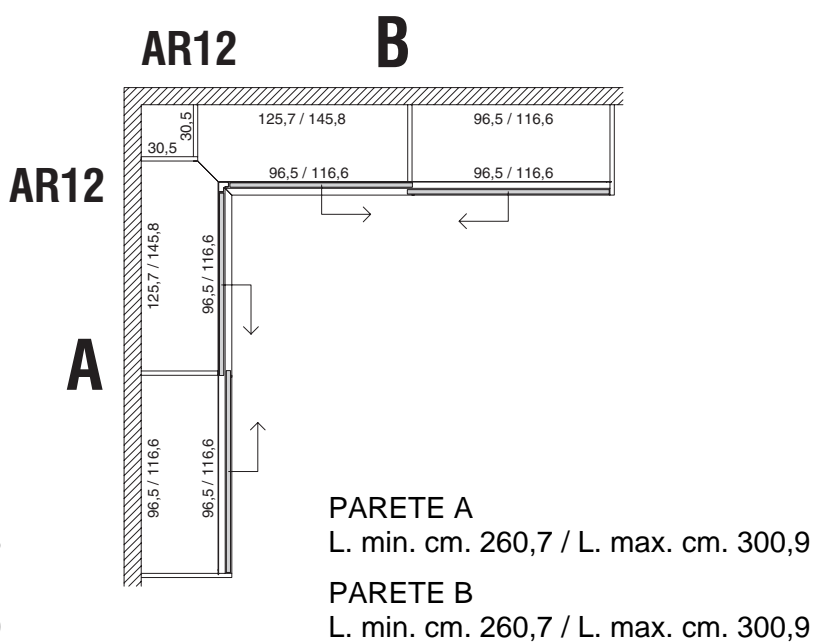
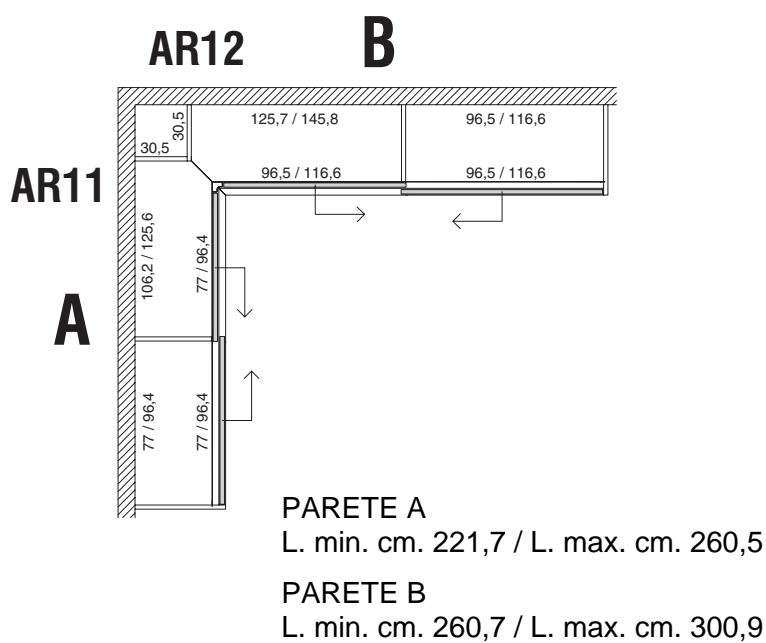
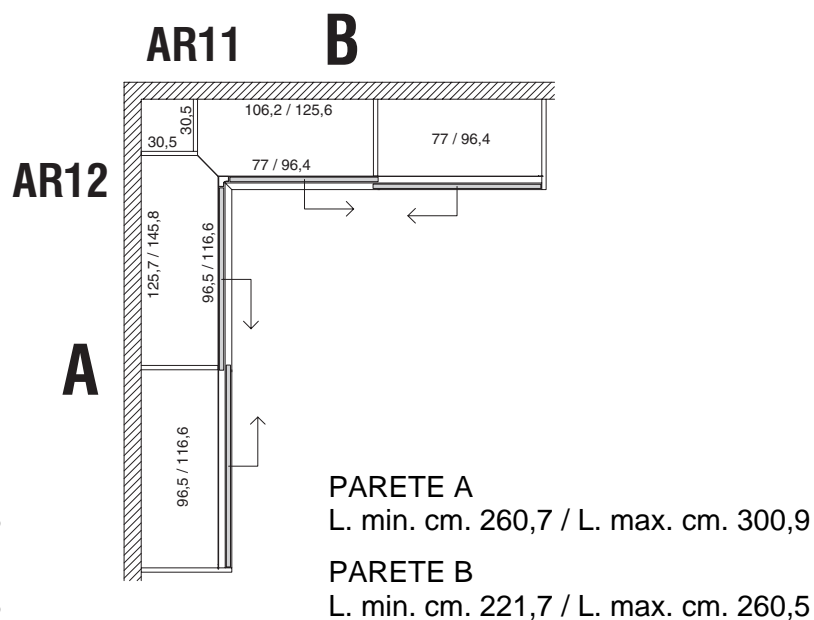
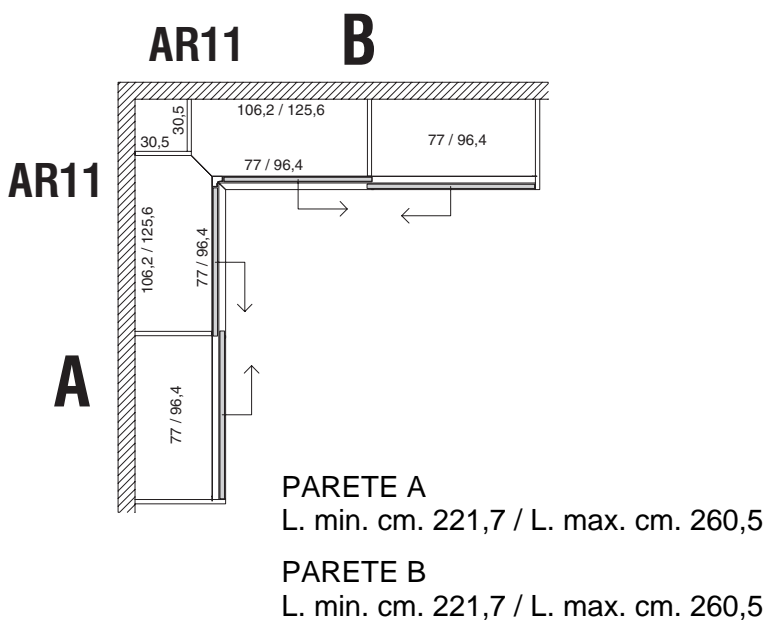
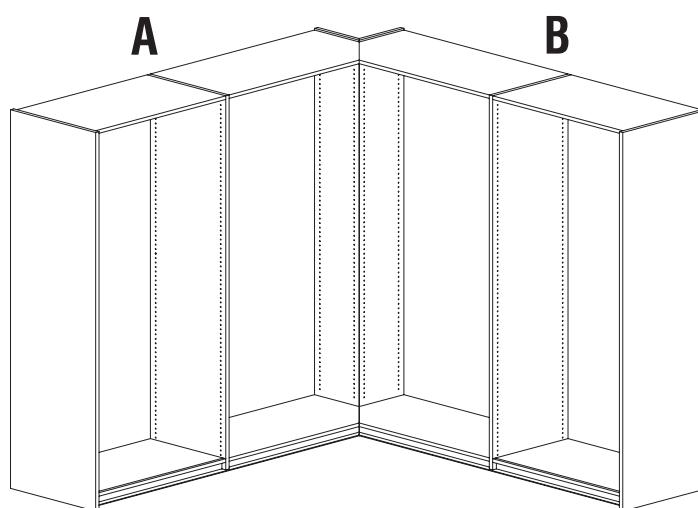

**PARETE A**

L. min. cm. 221,7 / L. max. cm. 300,9

**Struttura armadio posteriore**

L. min. cm. 191,2 / L. max. cm. 270,4

**Struttura armadio anteriore**

L. min. cm. 163,7 / L. max. cm. 242,9

**PARETE B**

L. min. cm. 301,2 / L. max. cm. 420

**Struttura armadio posteriore**

L. min. cm. 270,7 / L. max. cm. 389,5

**Struttura armadio anteriore**

L. min. cm. 243,2 / L. max. cm. 362

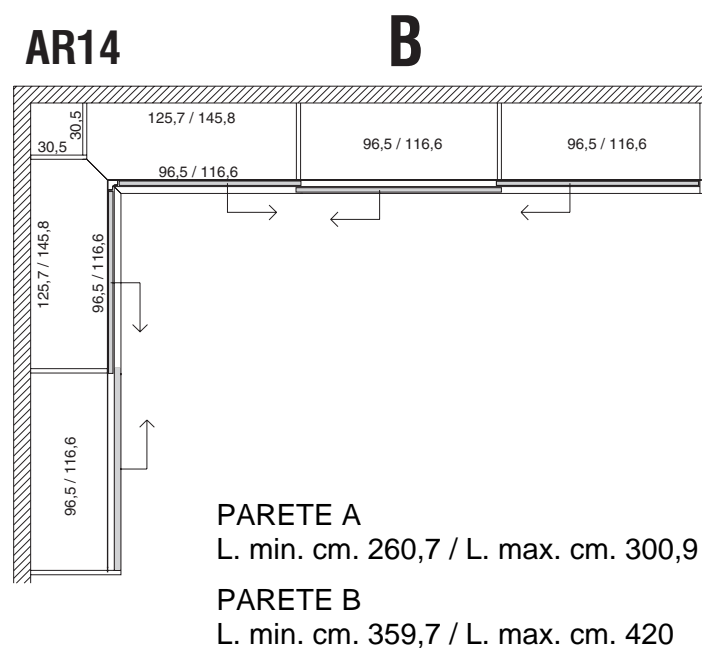
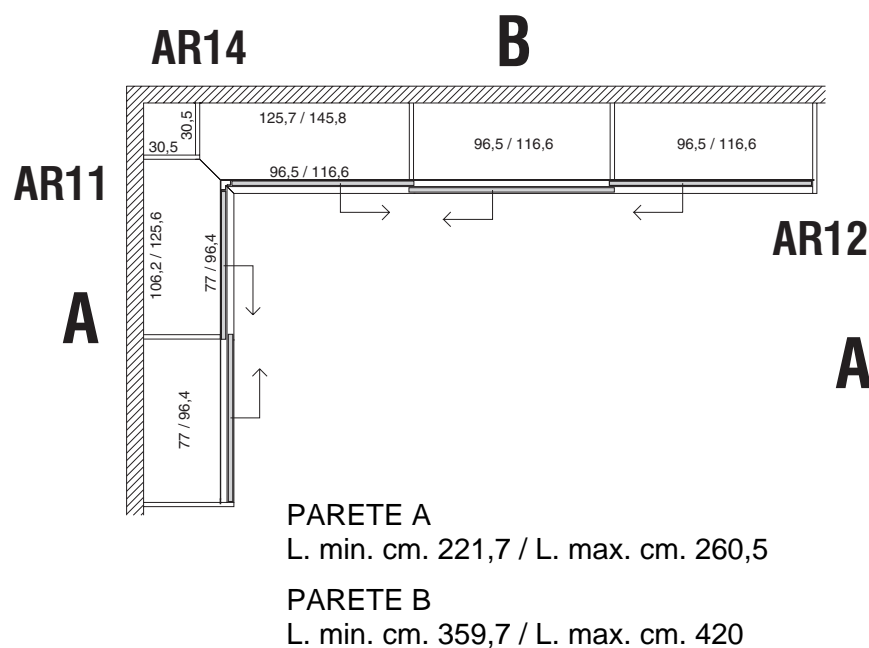
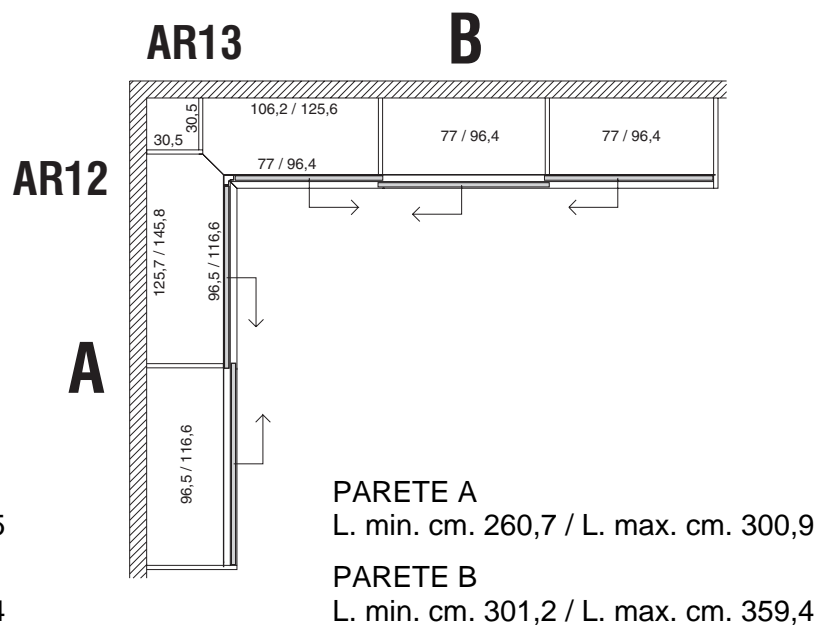
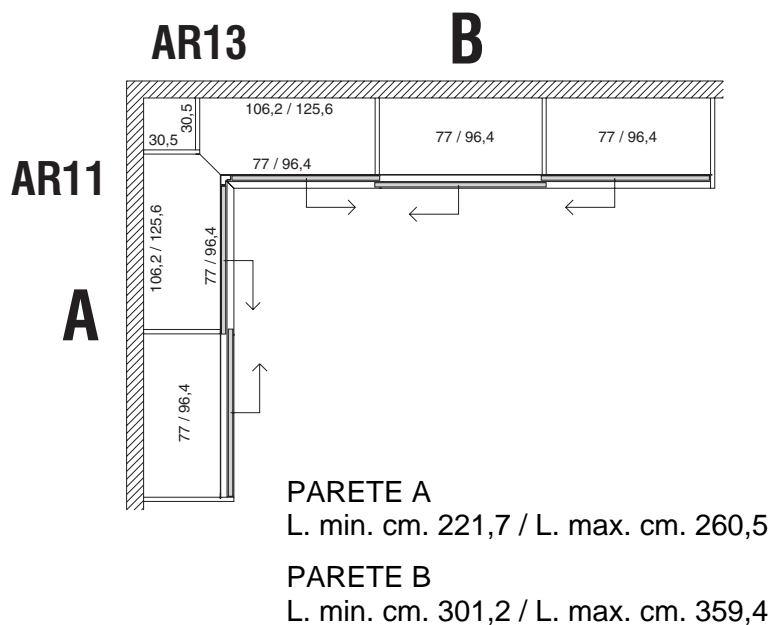
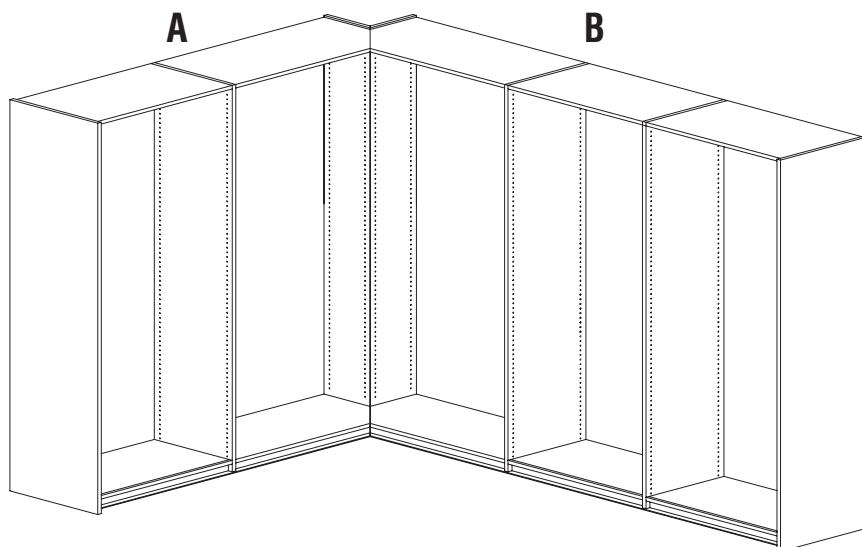

**PARETE A**

L. min. cm. 301,2 / L. max. cm. 420

**Struttura armadio posteriore**

L. min. cm. 270,7 / L. max. cm. 389,5

**Struttura armadio anteriore**

L. min. cm. 243,2 / L. max. cm. 362

**PARETE B**

L. min. cm. 221,7 / L. max. cm. 300,9

**Struttura armadio posteriore**

L. min. cm. 191,2 / L. max. cm. 270,4

**Struttura armadio anteriore**

L. min. cm. 163,7 / L. max. cm. 242,9

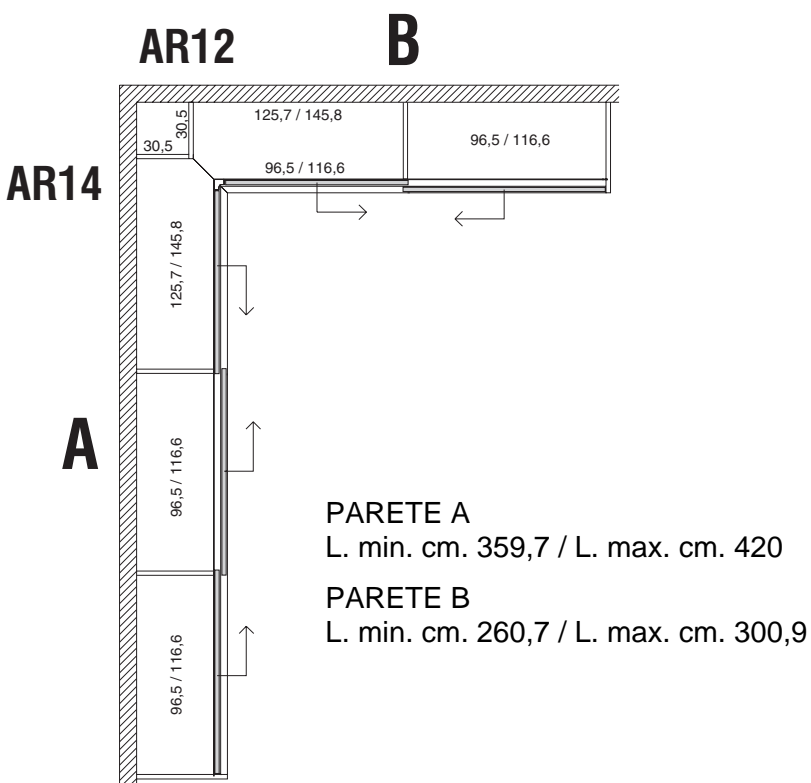
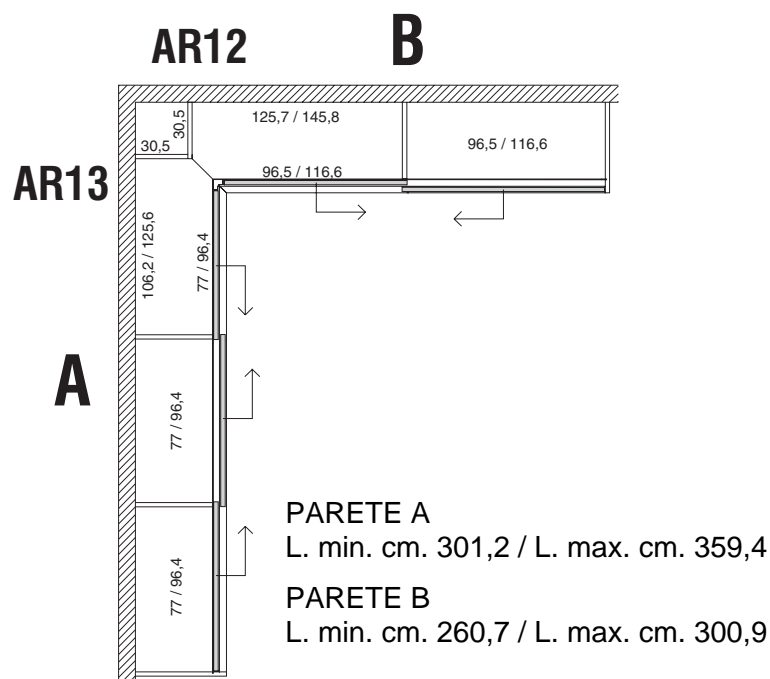
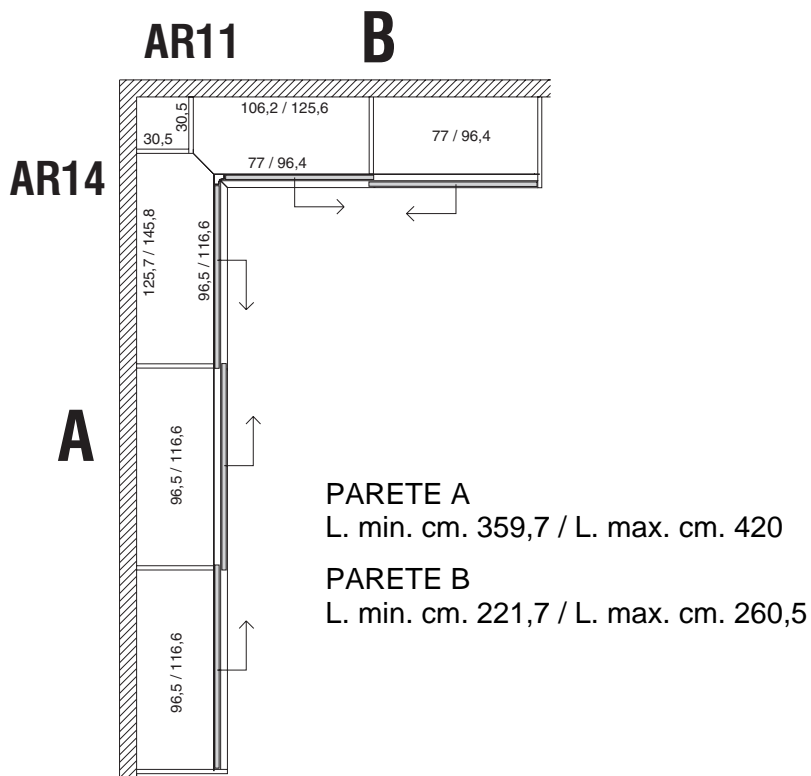
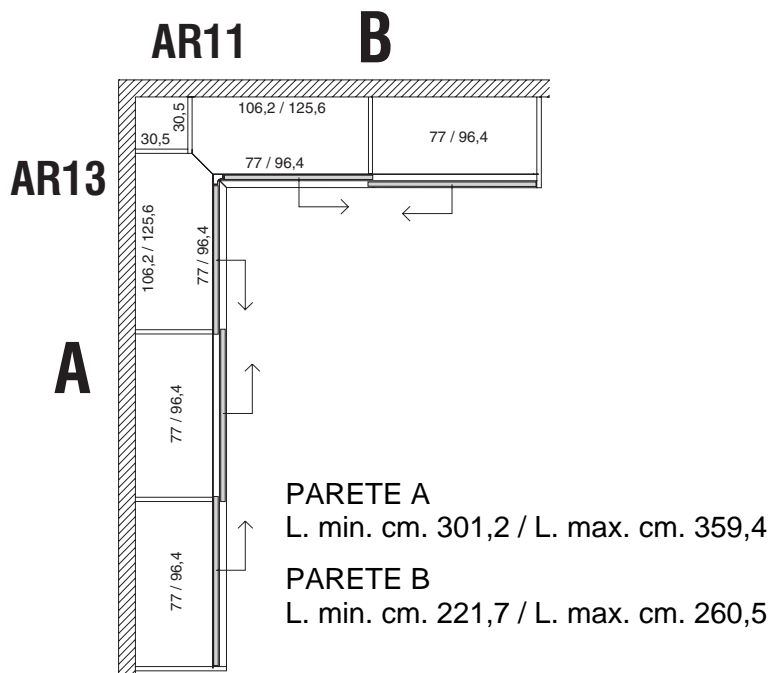
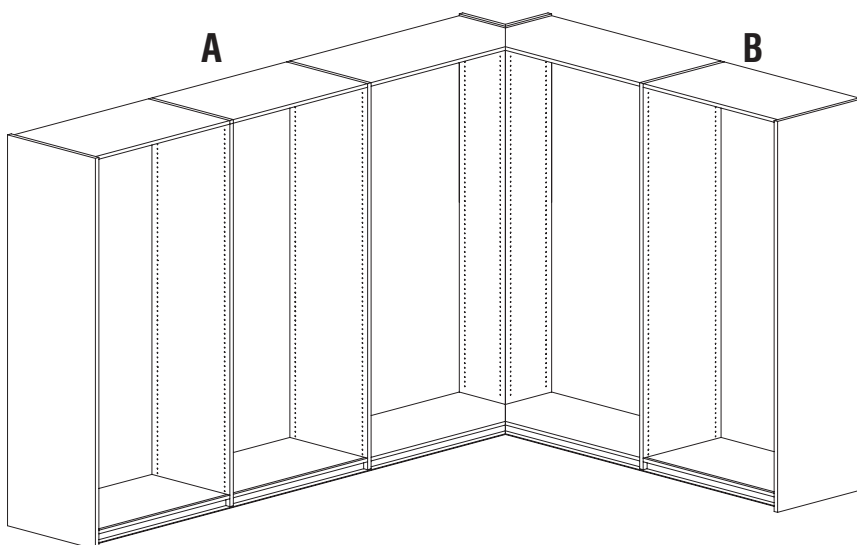

**PARETE A e PARETE B**

L. min. cm. 301,2 / L. max. cm. 420

**Struttura armadio posteriore**

L. min. cm. 270,7 / L. max. cm. 389,5

**Struttura armadio anteriore**

L. min. cm. 243,2 / L. max. cm. 362

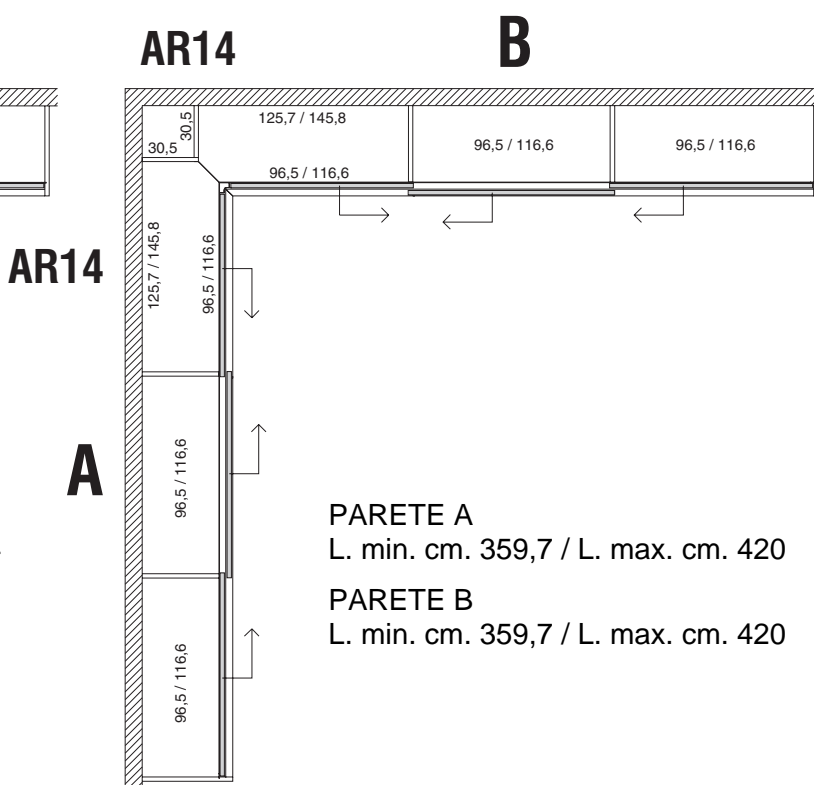
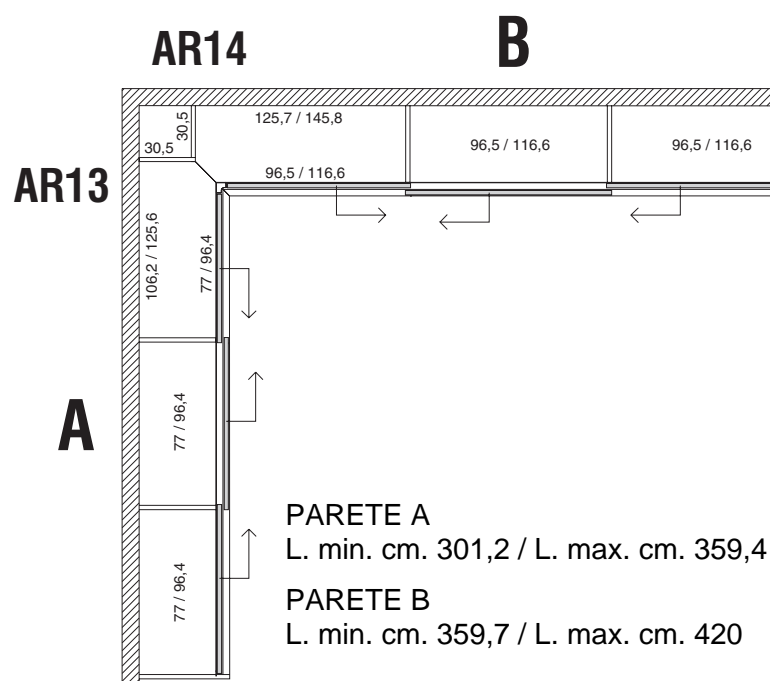
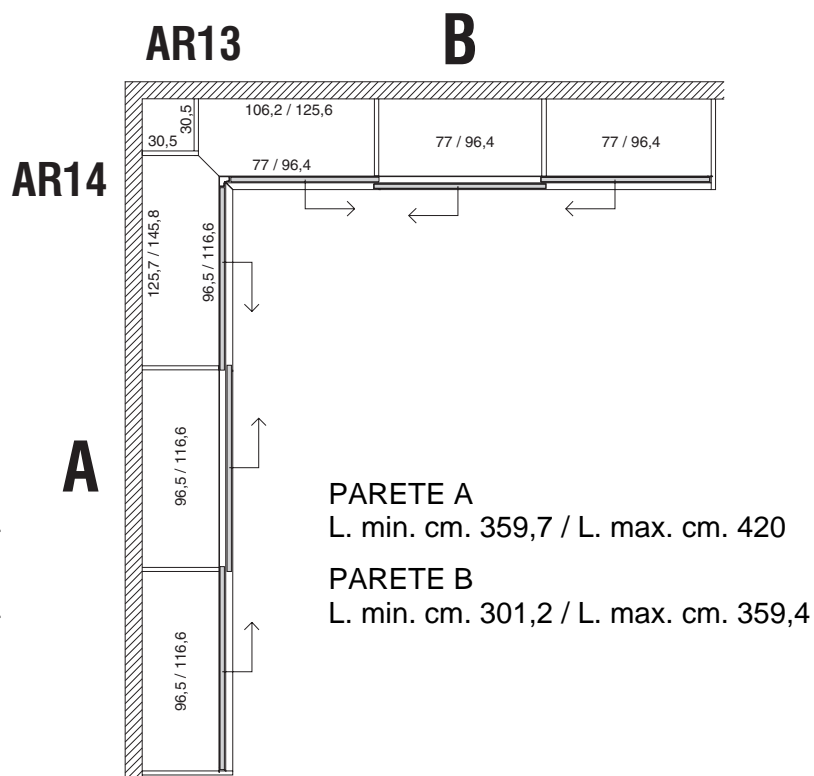
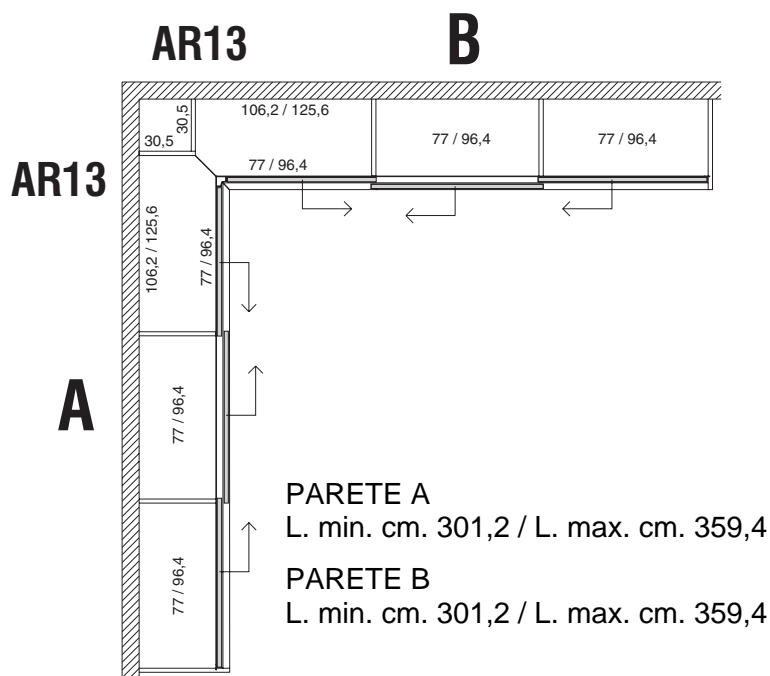
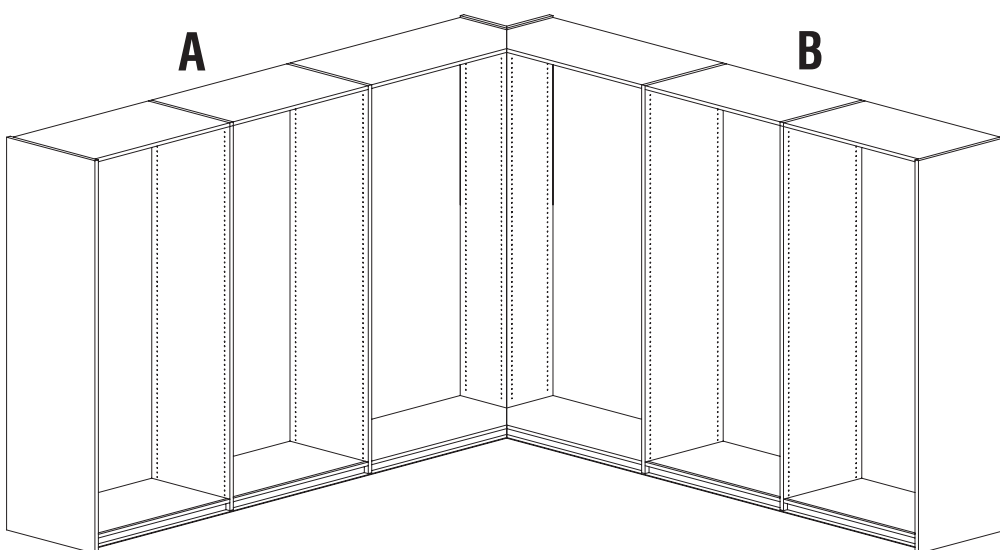



	<b>PARETE</b>	<b>Struttura armadio posteriore</b>	<b>Struttura armadio anteriore</b>	<b>Numero moduli (porte)</b>	<b>Larghezza modulo (porte)</b>
<b>AR11</b>	da L. 221,7	191,2	163,7	<b>2</b>	77
	a L. 260,5	230	202,5	<b>2</b>	96,4

	fino a H. 240	da H. 241 a 270	Da H. 271 a 300
Nobilitato	<b>AR11240</b>	<b>AR11270</b>	<b>AR11300</b>
	1.261	1.336	1.412
Fianchi laterali laccato	<b>AR11240L</b>	<b>AR11270L</b>	<b>AR11300L</b>
	1.381	1.480	1.575

	<b>PARETE</b>	<b>Struttura armadio posteriore</b>	<b>Struttura armadio anteriore</b>	<b>Numero moduli (porte)</b>	<b>Larghezza modulo (porte)</b>
<b>AR12</b>	da L. 260,7	230,2	202,7	<b>2</b>	96,5
	a L. 300,9	270,4	242,9	<b>2</b>	116,6

	fino a H.240	da H. 241 a 270	Da H. 271 a 300
Nobilitato	<b>AR12240</b>	<b>AR12270</b>	<b>AR12300</b>
	1.465	1.539	1.614
Fianchi laterali laccato	<b>AR12240L</b>	<b>AR12270L</b>	<b>AR12300L</b>
	1.585	1.681	1.779

	<b>PARETE</b>	<b>Struttura armadio posteriore</b>	<b>Struttura armadio anteriore</b>	<b>Numero moduli (porte)</b>	<b>Larghezza modulo (porte)</b>
<b>AR13</b>	da L. 301,2	270,7	243,2	<b>3</b>	77
	a L. 359,4	328,9	301,4	<b>3</b>	96,4

	fino a H.240	da H. 241 a 270	Da H. 271 a 300
Nobilitato	<b>AR13240</b>	<b>AR13270</b>	<b>AR13300</b>
	1.712	1.816	1.921
Fianchi laterali laccato	<b>AR13240L</b>	<b>AR13270L</b>	<b>AR13300L</b>
	1.831	1.960	2.085

	<b>PARETE</b>	<b>Struttura armadio posteriore</b>	<b>Struttura armadio anteriore</b>	<b>Numero moduli (porte)</b>	<b>Larghezza modulo (porte)</b>
<b>AR14</b>	da L. 359,7	329,2	301,7	<b>3</b>	96,5
	a L. 420	389,5	362	<b>3</b>	116,6

	fino a H.240	da H. 241 a 270	Da H. 271 a 300
Nobilitato	<b>AR14240</b>	<b>AR14270</b>	<b>AR14300</b>
	2.056	2.162	2.265
Fianchi laterali laccato	<b>AR14240L</b>	<b>AR14270L</b>	<b>AR14300L</b>
	2.177	2.304	2.429

## FIANCHI Sp. 2,5



Altezza	LATERALE			INTERNO		
	fino a H. 240	da H. 241 a 270	da H. 271 a 300	fino a H. 240	da H. 241 a 270	da H. 271 a 300
Nobilitato	AR71 212	AR72 226	AR73 241	AR77 167	AR78 181	AR79 197
Laccato	AR74 332	AR75 370	AR76 407			

## BASAMENTI sp. 2,5 prof. 58

fino a L. 51,4

da L.51,5 a 66,4

da L.66,5 a 96,4

da L. 96,5 a 145,8  
con rinforzo

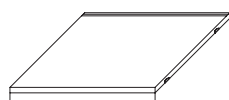
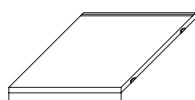

AR80	92	AR81	100	AR82	106	AR83	129
------	----	------	-----	------	-----	------	-----

## COPERCHI sp. 2,5 prof. 58

fino a L. 51,4

da L.51,5 a 66,4

da L.66,5 a 96,4

da L. 96,5 a 145,8  
con rinforzo

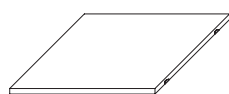
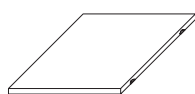

AR84	77	AR85	84	AR86	92	AR87	137
------	----	------	----	------	----	------	-----

## SCHIENALI sp. 1

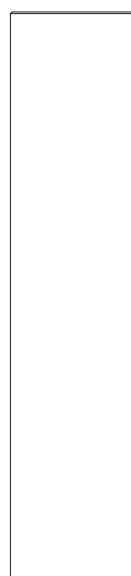

Altezza	fino a H. 240	da H. 241 a 270	da H. 271 a 300
Fino a L. 51,4	AR88 70	AR89 77	AR90 84
da L. 51,5 a 66,4	AR91 77	AR92 84	AR93 92
da L. 66,5 a 96,4	AR94 92	AR95 106	AR96 123
da L. 96,5 a 145,8	AR97 167	AR98 181	AR99 197

# PIÙ IN ALTO

## CANNE APPENDIABILI

fino a L. 51,4

da L.51,5 a 66,4

da L.66,5 a 96,4

da L.96,5 a 145,8



AR100	19	AR101	20	AR102	21	AR103	26
-------	----	-------	----	-------	----	-------	----

## APPENDIABITI SALISCENDI - Portata max. kg. 10

fino a L. 51,4

da L.51,5 a 66,4

da L.66,5 a 96,4

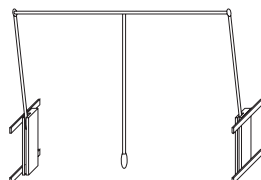
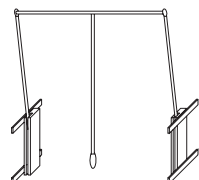
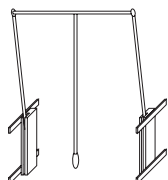

AR104	326	AR105	326	AR106	326
-------	-----	-------	-----	-------	-----

## RIPIANI sp. 2,5 prof. 56,3

fino a L. 51,4

da L.51,5 a 66,4

da L.66,5 a 96,4

da L.96,5 a 145,8  
con rinforzo

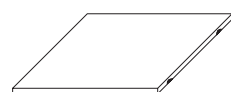
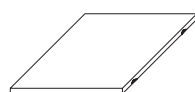

AR107	51	AR108	54	AR109	61	AR110	100
-------	----	-------	----	-------	----	-------	-----

## RIPIANI sp. 2,5 prof. 56,3 con canna appendiabiti

fino a L. 51,4

da L.51,5 a 66,4

da L.66,5 a 96,4

da L.96,5 a 145,8  
con rinforzo

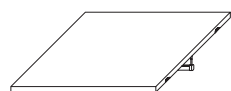
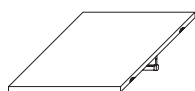

AR111	67	AR112	73	AR113	80	AR114	124
-------	----	-------	----	-------	----	-------	-----

## RIPIANI ANGOLARI sp. 2,5 prof. 56,3

da L.106,2 a 145,8  
con rinforzo

da L.106,2 a 145,8  
con rinforzo

da L.106,2 a 145,8  
con rinforzo

da L.106,2 a 145,8  
con rinforzo

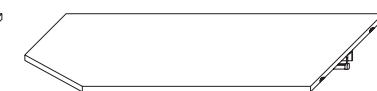
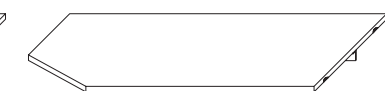
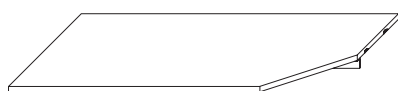

AR115	137	AR116	137	AR117	162	AR118	162
-------	-----	-------	-----	-------	-----	-------	-----

## PORTAPANTALONI

ad estrazione totale con  
BLUMOTION L. 96,4 P. 56,3

## RIPIANO

con piano scrittoio ad estrazione  
totale con BLUMOTION  
L. 96,4 P. 56,3

## PORTACAMICIE

L. 96,4 H. 35 P. 51

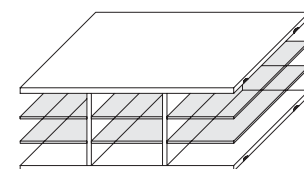
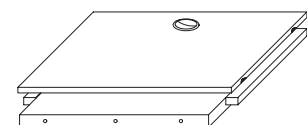
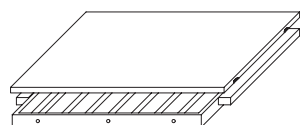

AR119	302	AR12120	346	AR12121	361
-------	-----	---------	-----	---------	-----

**CASSETTIERE INTERNE**

Le cassettiere interne vengono fornite con cassetti in misura standard **L. 41,4** (per modulo L. 51,4), **L. 56,4** (per modulo L. 66,4), **L. 86,4** (per modulo L. 96,4) con due spalle laterali L. 5.

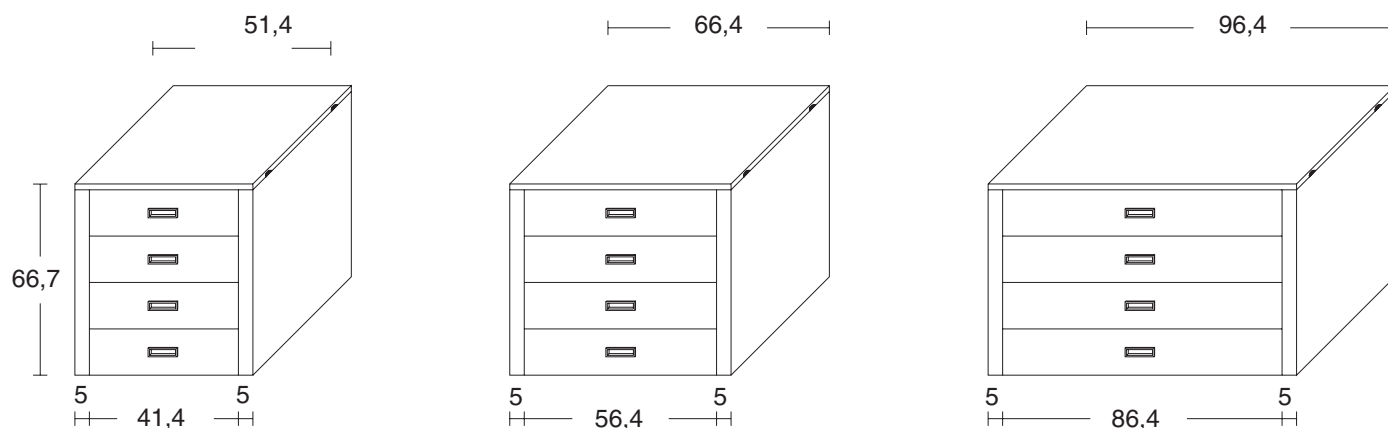

Le cassettiere sono dotate di due fasce laterali di compensazione qualora vengano inserite in struttura armadio in larghezza da 51,5 a 66,3, e da 66,5 a 96,3.

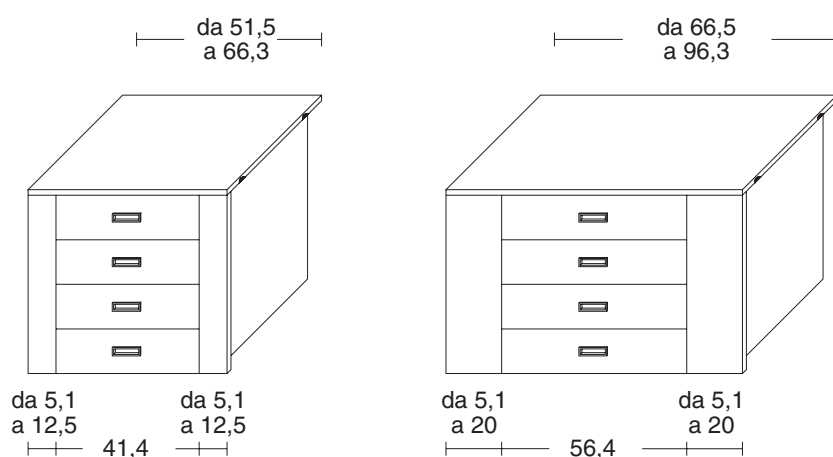

**ESEMPIO DI CASSETTIERA INTERNA PER MODULO L. 91,5**

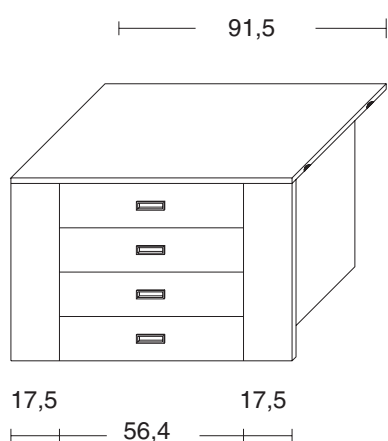

I cassetti con frontale in legno sono dotati di maniglia ad incasso, guida a scomparsa ad estrazione totale con BLUMOTION.

I cassetti sono disponibili in tre altezze: 15,8 - 23,8 - 31,8

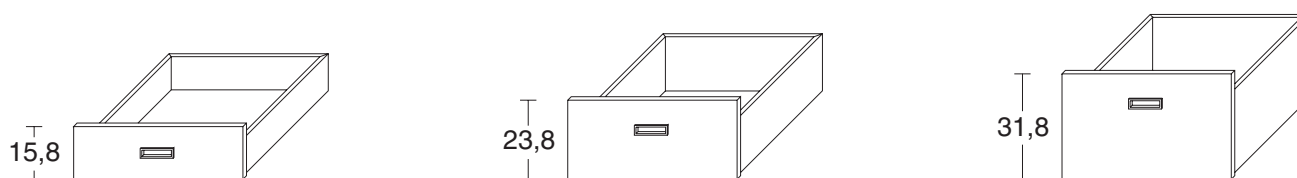

# PIÙ IN ALTO

## CASSETTIERE INTERNE P. 56,3

L. 51,4 - H. 66,7

L. 51,4 - H. 66,7

L. 51,4 - H. 66,7

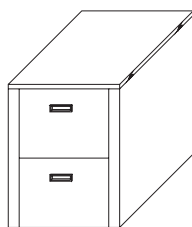
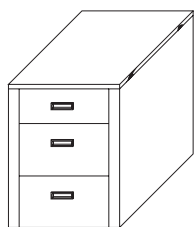
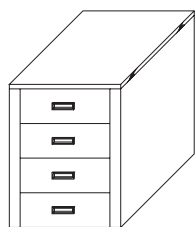

**AR120** 600

**AR121** 537

**AR122** 456

da L. 51,5 a 66,3 - H. 66,7

da L. 51,5 a 66,3 - H. 66,7

da L. 51,5 a 66,3 - H. 66,7

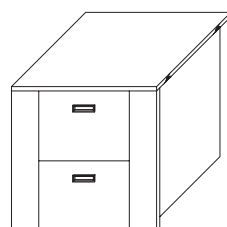
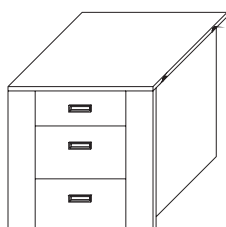
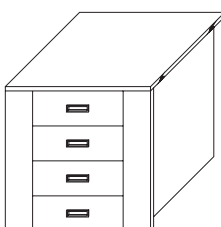

**AR124** 603

**AR125** 539

**AR126** 461

L. 66,4 - H. 66,7

L. 66,4 - H. 66,7

L. 66,4 - H. 66,7

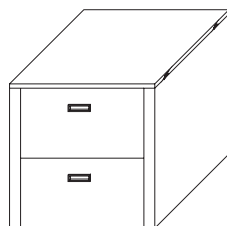
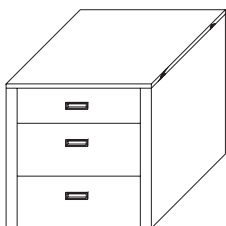

**AR128** 633

**AR129** 567

**AR130** 490

da L. 66,5 a 96,3 - H. 66,7

L. da 66,5 a 96,3 - H. 66,7

L. da 66,5 a 96,3 - H. 66,7

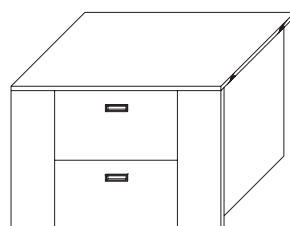
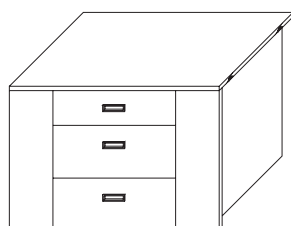

**AR132** 641

**AR133** 575

**AR134** 495

L. 96,4 - H. 66,7

L. 96,4 - H. 66,7

L. 96,4 - H. 66,7

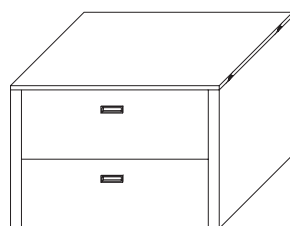

**AR136** 670

**AR137** 604

**AR138** 525

# PIÙ IN ALTO

## CASSETTIERE INTERNE P. 56,3

da L. 96,5 a 148,5 - H. 66,7

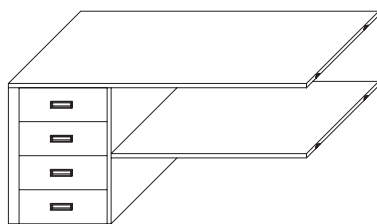

L. 41,4

AR140 687

da L. 96,5 a 148,5 - H. 66,7



L. 56,4

AR141 717

da L. 96,5 a 148,5 - H. 66,7



L. 86,4

AR142 738

## ATTREZZATURE

Appendiabiti estraibile  
da fissare sotto al ripiano  
L. 43

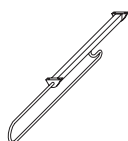

AR143 26

Portacravatte estraibile  
L. 50 - H. 9

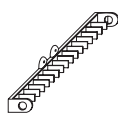

AR144 81

Portacinture estraibile  
L. 50 - H. 9



AR145 140

Portagonne  
portapantaloni estraibile  
L. 50 - H. 9 - P. 20

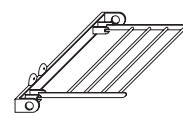

AR146 148

Portascarpe estensibile  
in filo di ferro prof. 20  
fino a L. 96,4



AR147 47

Vaschetta in lamiera  
per portascarpe estensibile  
(facoltativo)

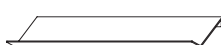

AR148 70

Vassoio in lamiera  
per ripiano  
L. 96,4 - prof. 56,3

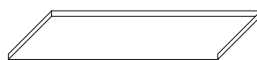

AR149 167

Specchio estraibile  
L. 35 - H. 150

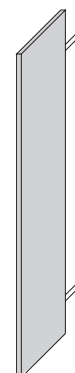

AR150 345

## PIÙ IN ALTO

Per semplificare l'uso del listino, proponiamo composizioni di strutture armadio attrezzate, complete di porte scorrevoli.

Le quote si riferiscono alle dimensioni della struttura armadio, escluso gli spazi necessari per il montaggio, come descritto a pag. PA05

- ES. 1      Struttura armadio con due lati liberi: non aggiungere gli spazi per il montaggio.
- ES. 2      Struttura armadio con un lato libero: aggiungere cm. 4 necessari per il montaggio.  
(es. struttura armadio L. cm. 140,3 - parete cm. 144,3)
- ES. 3      Struttura armadio in nicchia: aggiungere cm. 8 necessari per il montaggio.  
(es. struttura armadio L. cm. 140,3 - parete cm. 148,3)

Le dimensioni delle porte in larghezza si riferiscono al mod. ROUND 34.

É possibile tuttavia utilizzare anche gli altri modelli, con il relativo calcolo delle quote da parte del ns. Ufficio Tecnico.

I prezzi si intendono riferiti a composizioni PIU' IN ALTO fino a H. cm. 270, con fianchi terminali nobilitato. I prezzi delle porte si intendono comprensivi di binari.

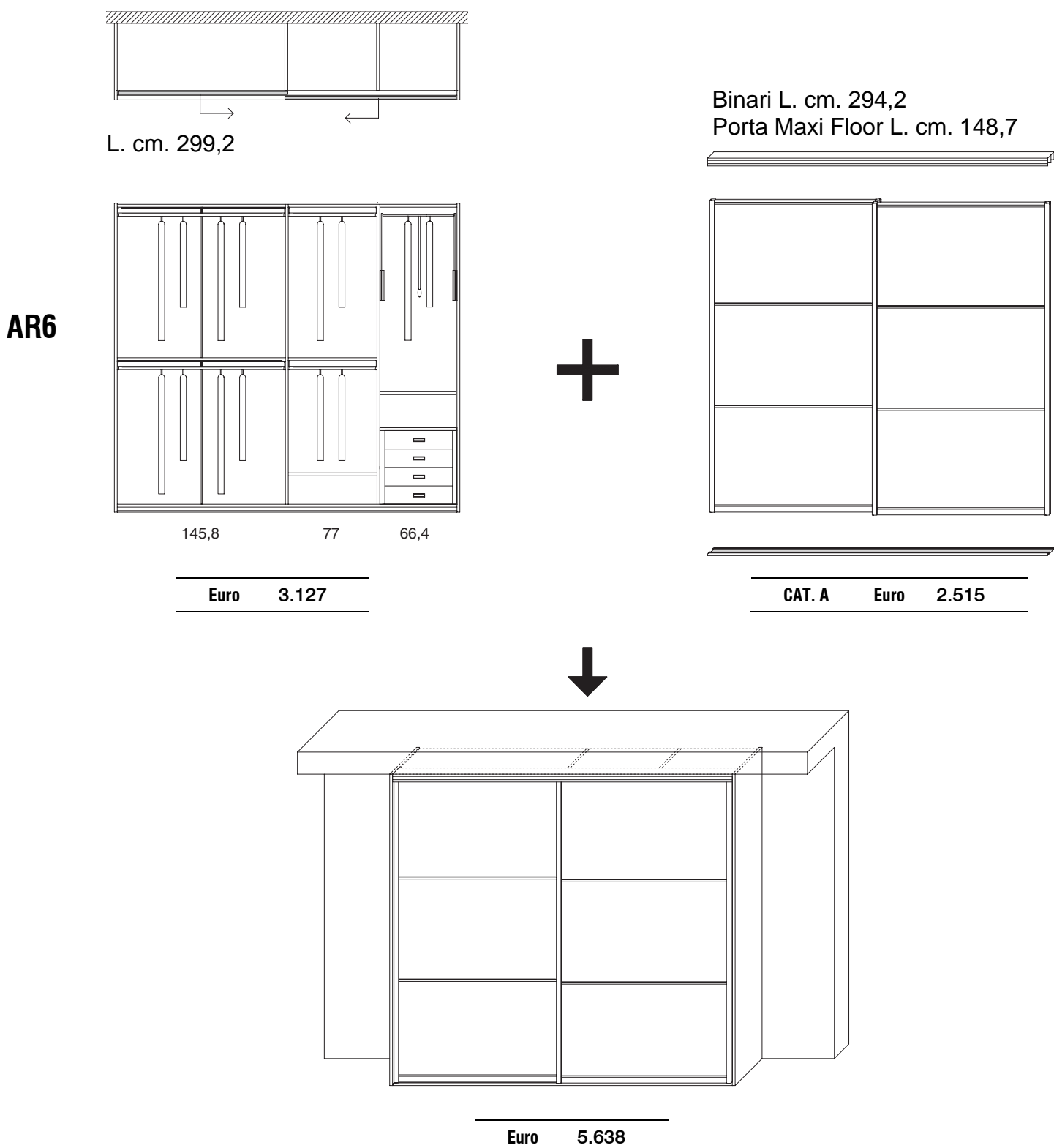

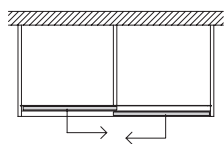

L. minima cm. 140,3

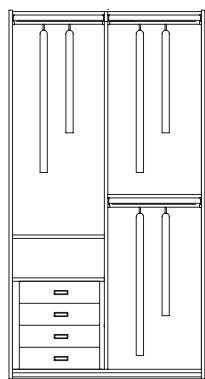

66,4 66,4

**Euro 2.022**

**AR1**

Binari L. cm. 135,3  
Porta L. cm. 69,3

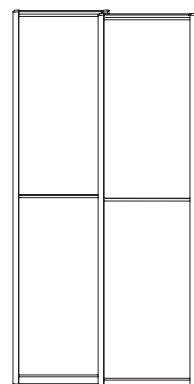

**CAT. A Euro 1.829**

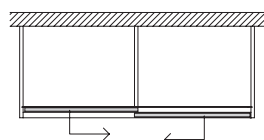

L. cm. 171,5

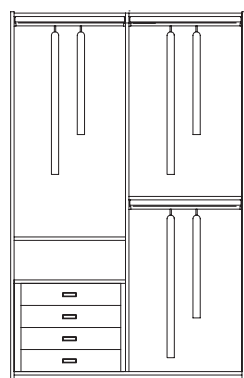

82 82

**Euro 2.050**

**AR1**

Binari L. cm. 166,5  
Porta L. cm. 84,9

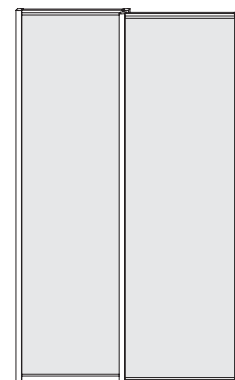

**CAT. D Euro 2.152**

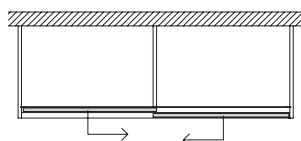

L. massima cm. 200,3

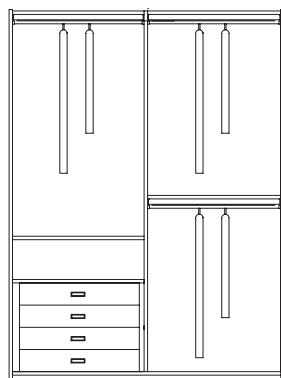

96,4 96,4

**Euro 2.079**

**AR1**

Binari L. cm. 195,3  
Porta L. cm. 99,3

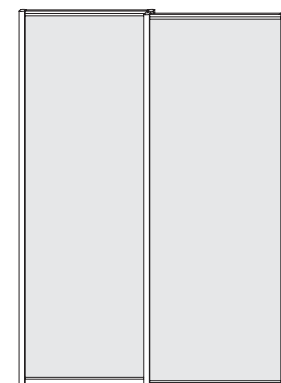

**CAT. D Euro 2.415**



**AR2**

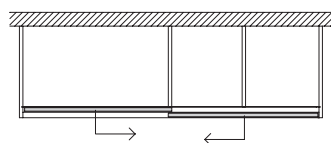

L. minima cm. 218,1

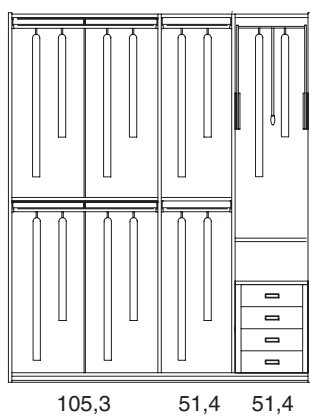

**Euro 2.975**

Binari L. cm. 213,1  
Porta L. cm. 108,2

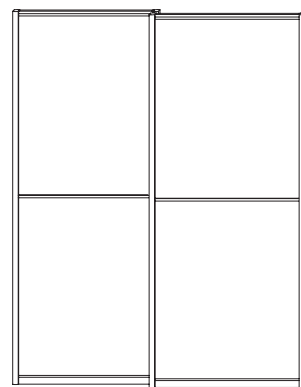

**CAT. A Euro 2.121**

**AR2**

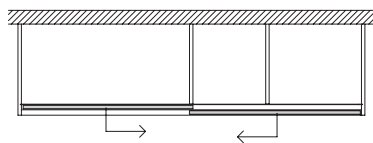

L. cm. 251,5

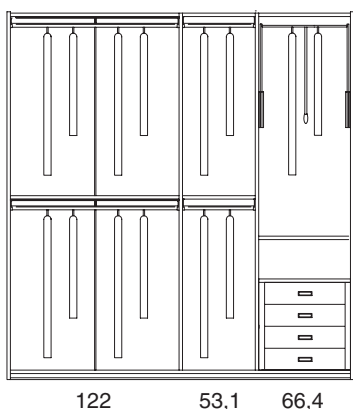

**Euro 3.017**

Binari L. cm. 246,5  
Porta L. cm. 124,9



**CAT. D Euro 2.700**

**AR2**

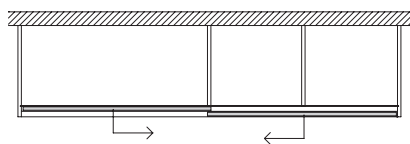

L. massima cm. 278,1

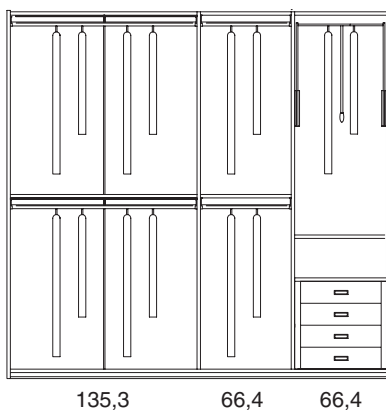

**Euro 3.017**

Binari L. cm. 273,1  
Porta Maxi Floor L. cm. 138,2

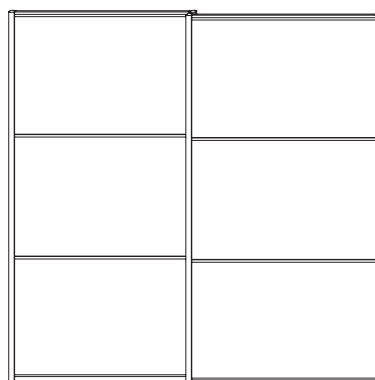

**CAT. A Euro 2.492**

**AR3**

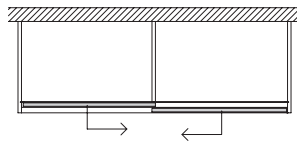

L. minima cm. 200,5

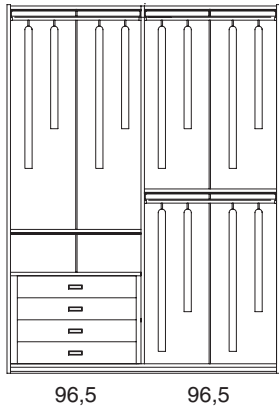

**Euro 2.474**

Binari L. cm. 195,5  
Porta L. cm. 99,4

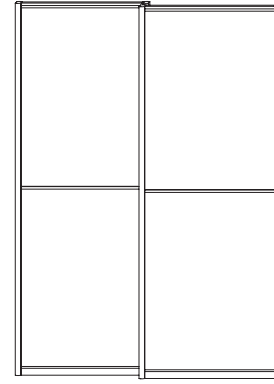

**CAT. A Euro 1.997**

**AR3**

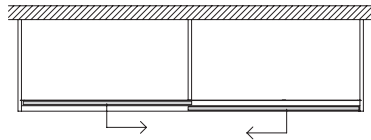

L. cm. 251,5

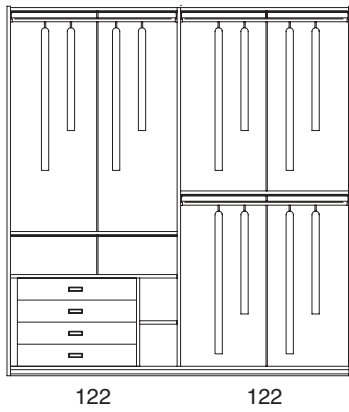

**Euro 2.519**

Binari L. cm. 246,5  
Porta L. cm. 124,9

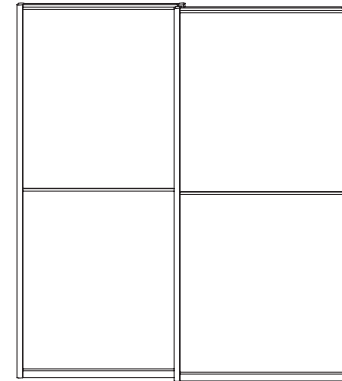

**CAT. A Euro 2.155**

**AR3**

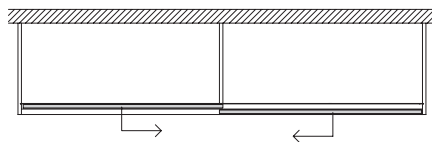

L. massima cm. 299,1

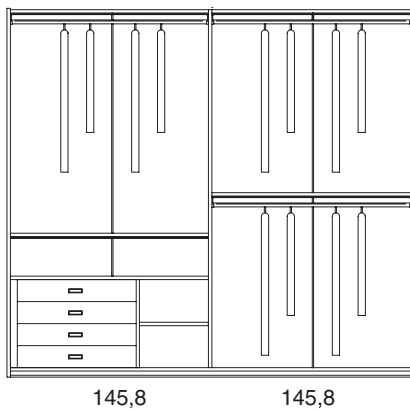

**Euro 2.519**

Binari L. cm. 294,1  
Porta Maxi Floor L. cm. 148,7

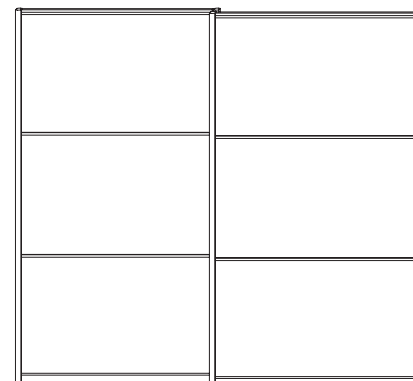

**CAT. A Euro 2.515**

**AR4**

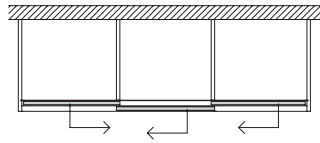

L. minima cm. 209,5

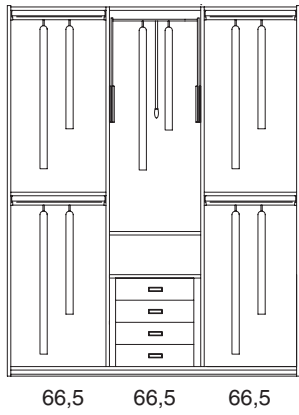

66,5 66,5 66,5

**Euro 2.929**

Binari L. cm. 204,5  
Porta L. cm. 70,3

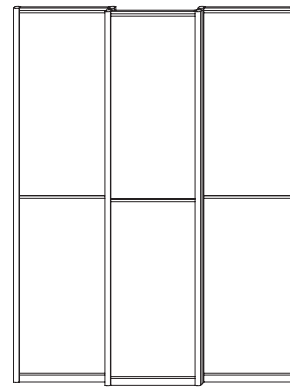

**CAT. A Euro 2.745**

**AR4**

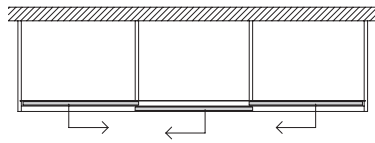

L. cm. 253,6

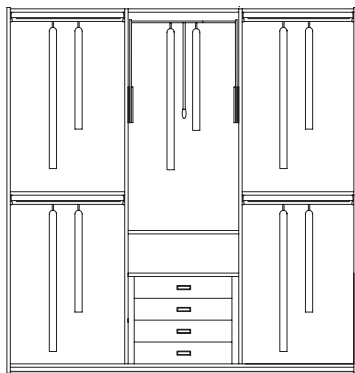

81,2 81,2 81,2

**Euro 2.929**

Binari L. cm. 248,6  
Porta L. cm. 85

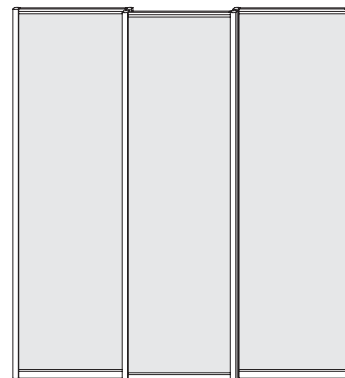

**CAT. D Euro 3.224**

**AR4**

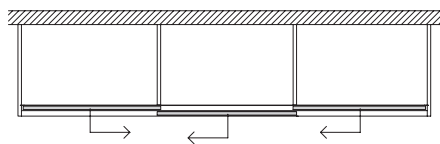

L. massima cm. 299,2

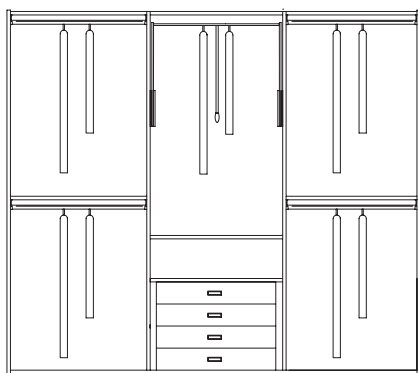

96,4 96,4 96,4

**Euro 2.960**

Binari L. cm. 294,2  
Porta L. cm. 100,2

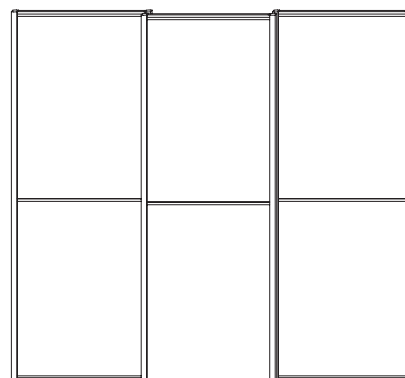

**CAT. A Euro 2.995**

**AR5**

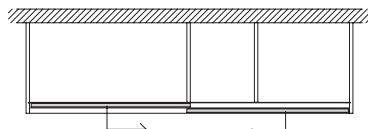

L. minima cm. 239,3

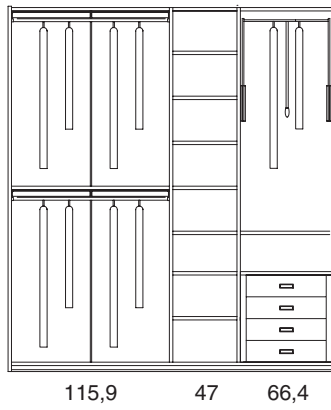

**Euro 3.314**

Binari L. cm. 234,3  
Porta L. cm. 118,8

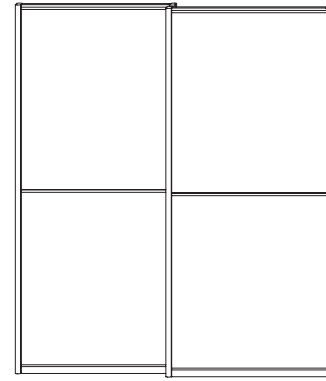
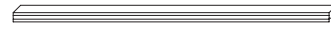

**CAT. A Euro 2.141**

**AR5**

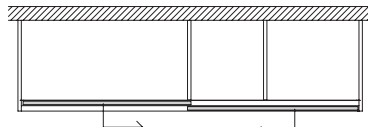

L. cm. 251,5

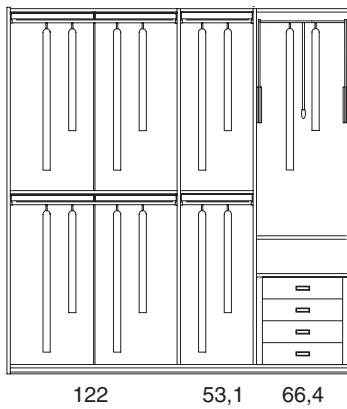

**Euro 3.056**

Binari L. cm. 246,5  
Porta L. cm. 124,9

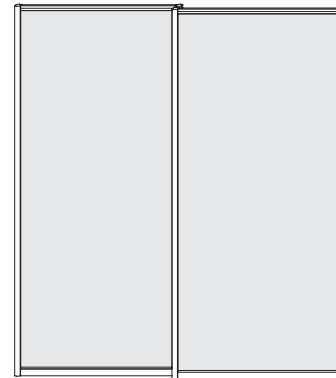

**CAT. D Euro 2.700**

**AR5**

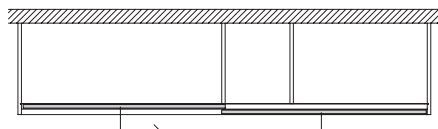

L. massima cm. 299,2

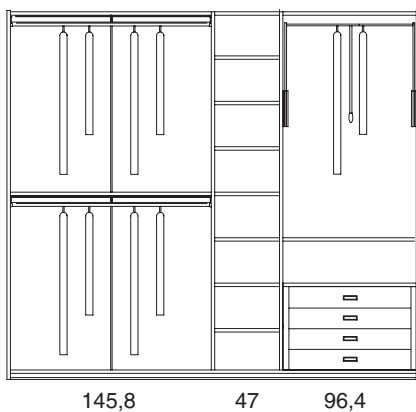

**Euro 3.359**

Binari L. cm. 294,2  
Porta Maxi Floor L. 148,7

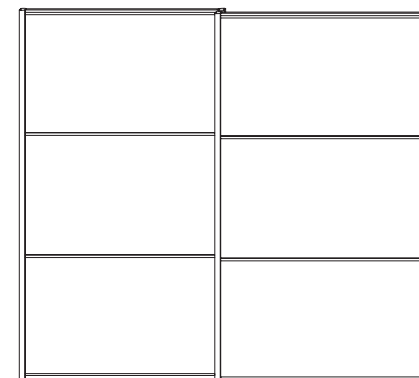

**CAT. A Euro 2.515**

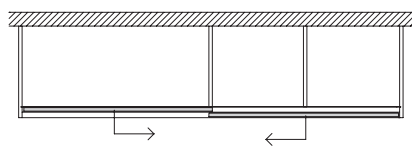

L. minima cm. 278,1

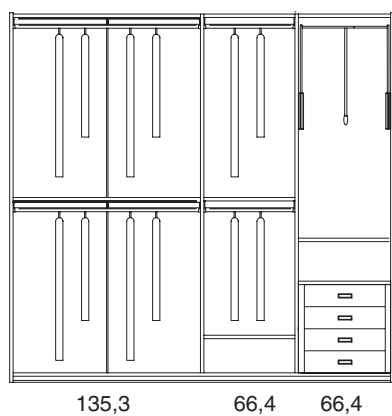

135,3      66,4      66,4

**Euro 3.109**

Binari L. cm. 273,1  
Porta Maxi Floor L. cm. 138,2

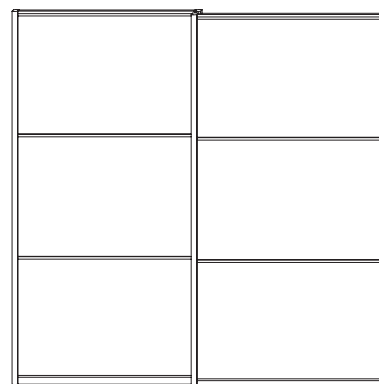

**CAT. A Euro 2.492**

**AR6**

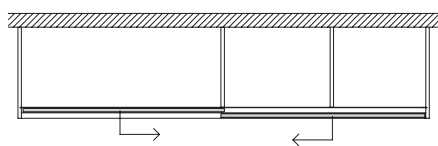

L. cm. 299,2

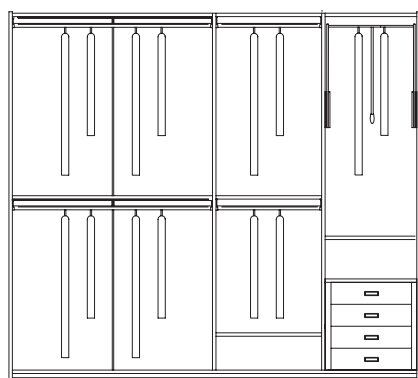

145,8      77      66,4

**Euro 3.127**

Binari L. cm. 294,2  
Porta Maxi Floor L. cm. 148,7

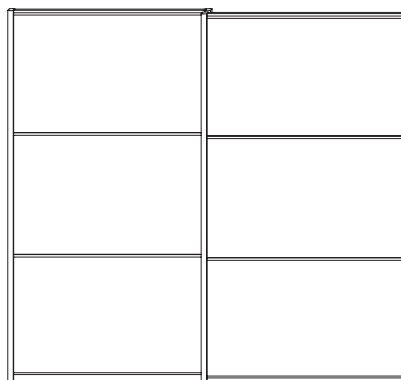

**CAT. A Euro 2.515**

**AR6**

**AR7**

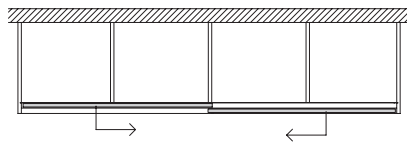

L. minima cm. 278,1

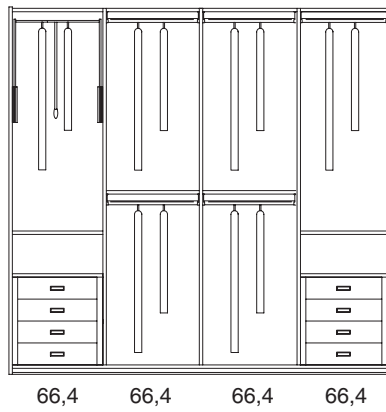

66,4 66,4 66,4 66,4

**Euro 4.075**

Binari L. cm. 273,1  
Porta Maxi Floor L. cm. 138,2

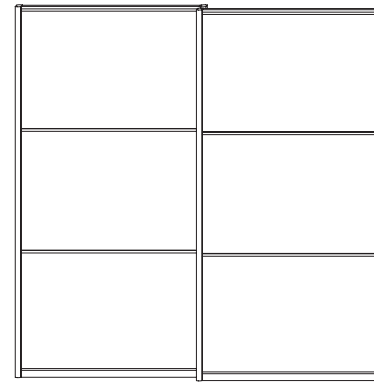

**CAT. A Euro 2.492**

**AR7**

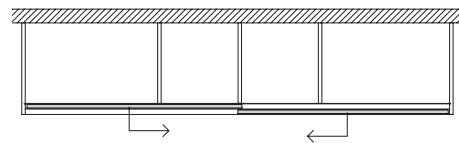

L. cm. 311,7

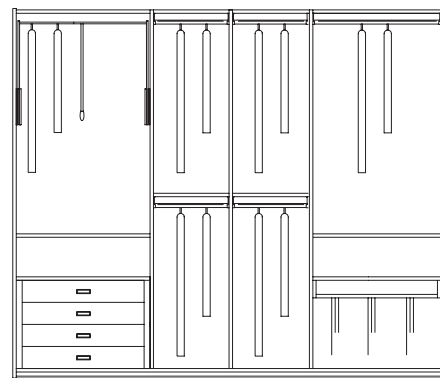

96,4 53,2 53,2 96,4

**Euro 3.799**

Binari L. cm. 306,7  
Porta Maxi Floor L. cm. 155

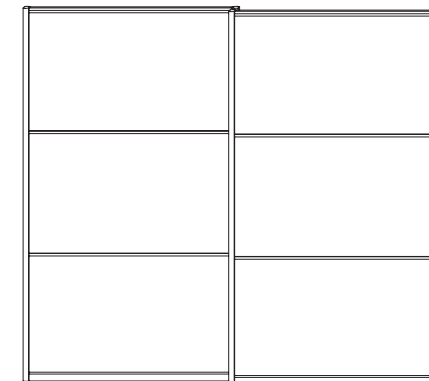

**CAT. A Euro 2.527**

**AR7**

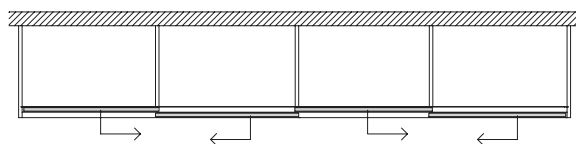

L. massima cm. 398,1

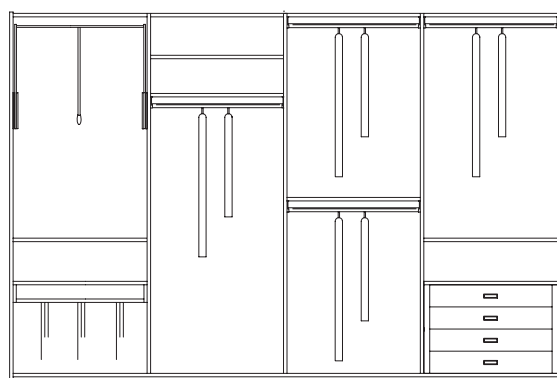

96,4 96,4 96,4 96,4

**Euro 3.859**

Binari L. cm. 393,1  
Porta L. cm. 100,7



**CAT. D Euro 4.862**

**AR8**

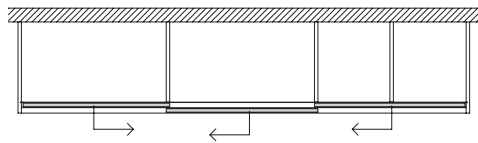

L. minima cm. 325,9

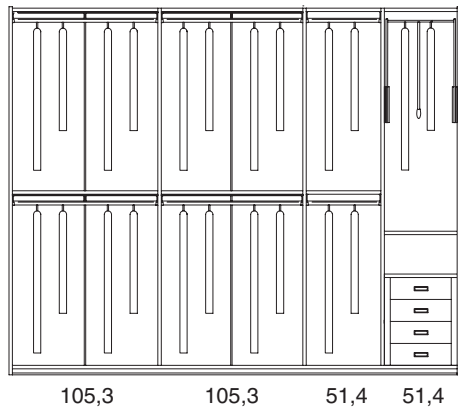

**Euro 3.745**

Binari L. cm. 320,9  
Porta L. cm. 109,1

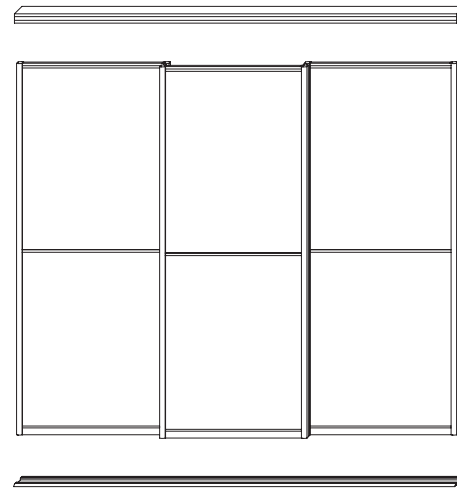

**CAT. A Euro 3.181**

**AR8**

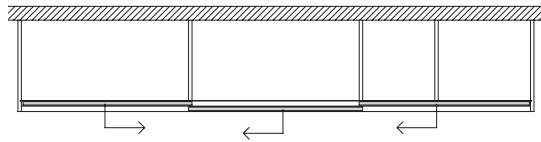

L. cm. 373

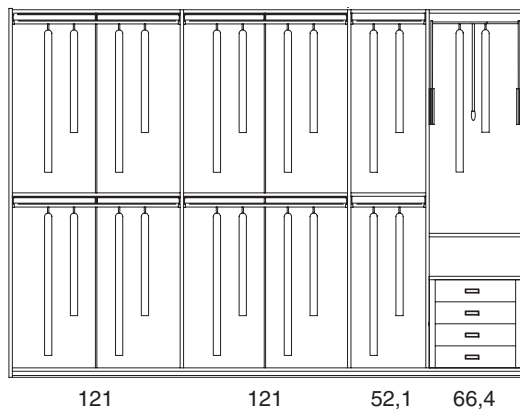

**Euro 3.786**

Binari L. cm. 368  
Porta L. cm. 124,8

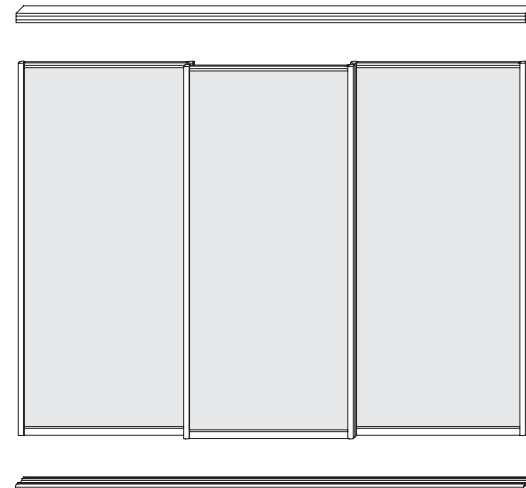

**CAT. D Euro 4.046**

**AR8**

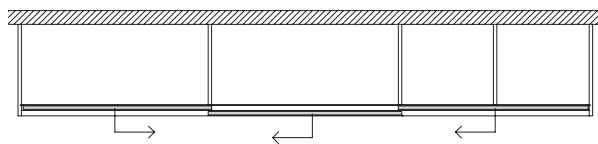

L. massima cm. 415,9

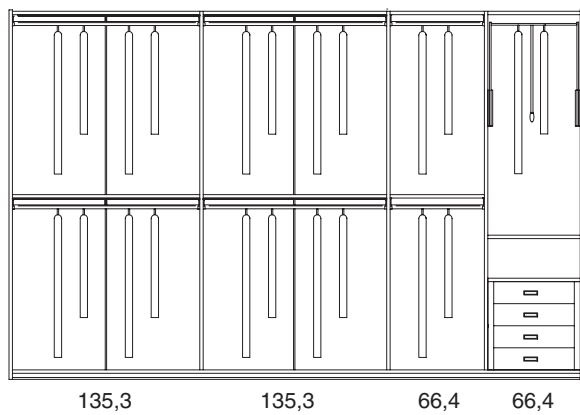

**Euro 3.786**

Binari L. cm. 410,9  
Porta Maxi Floor L. cm. 139,1

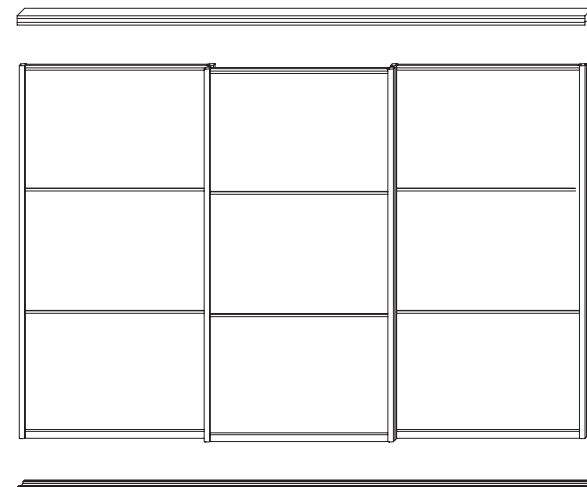

**CAT. A Euro 3.738**

**AR9**

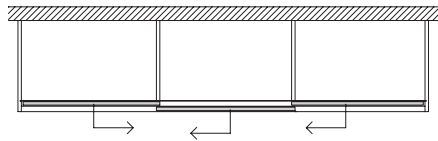

L. minima cm. 299,5

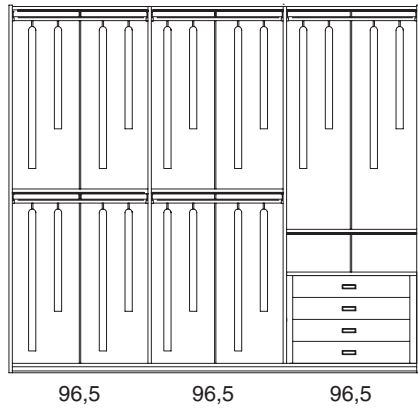

**Euro 3.242**

Binari L. cm. 294,5  
Porta L. cm. 100,3

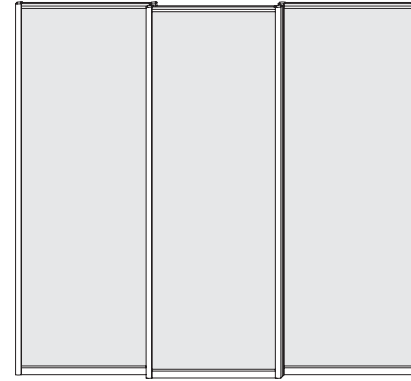

**CAT. D Euro 3.624**

**AR9**

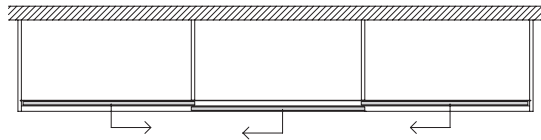

L. cm. 373

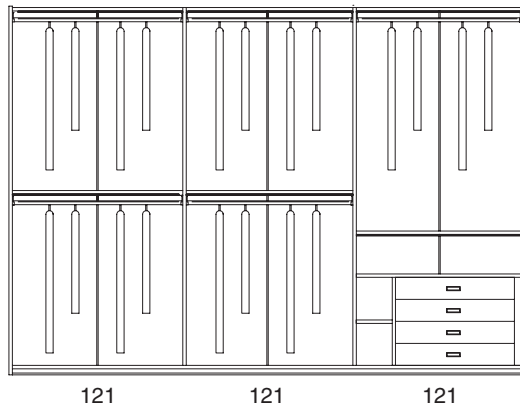

**Euro 3.287**

Binari L. cm. 368  
Porta L. cm. 124,8

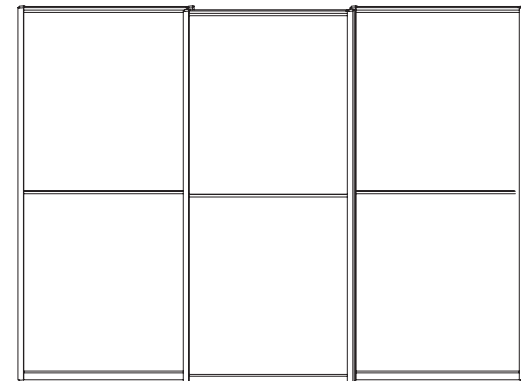

**CAT. A Euro 3.226**

**AR9**

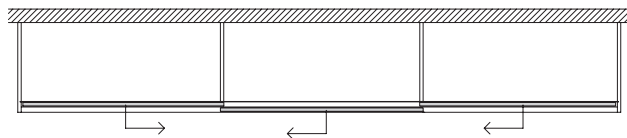

L. massima cm. 447,4

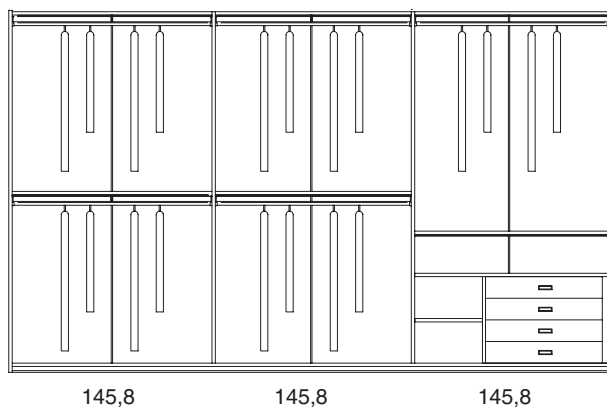

**Euro 3.287**

Binari L. cm. 442,4  
Porta Maxi Floor L. cm. 149,6

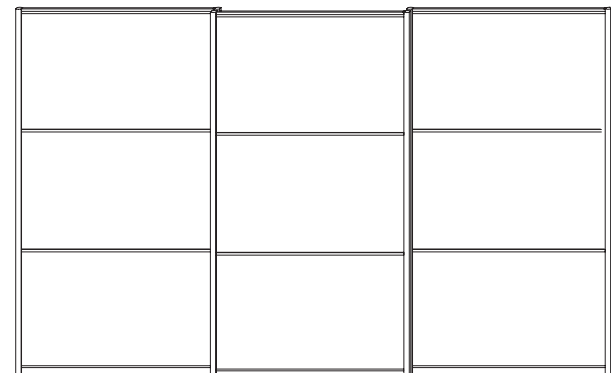

**CAT. A Euro 3.771**



## PIÙ IN ALTO DRESSING

Utilizzando le strutture armadio PIU' IN ALTO, è possibile realizzare vere e proprie cabine armadio chiuse con porte scorrevoli.

Le composizioni possono essere sviluppate su un'unica parete (dis. 1), su due pareti fronteggianti (dis. 2), o angolari a "L" (dis. 3), su tre pareti con disposizioni a "C" (dis. 4).

Data la versatilità del programma, si consiglia di avvalersi della consulenza del Ns. Ufficio Tecnico per progettazioni e preventivi.

Le porte scorrevoli, essendo svincolate dalla struttura armadio, possono essere realizzate nella tipologia FLOOR con binari superiore ed inferiore, o ARIA con binario superiore, compatibilmente con il modello della porta ed al contesto.

**1**

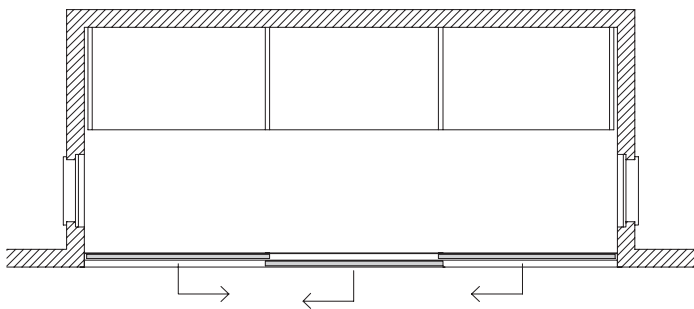

Struttura armadio prof. cm. 58  
3 porte scorrevoli complete di binario

**2**

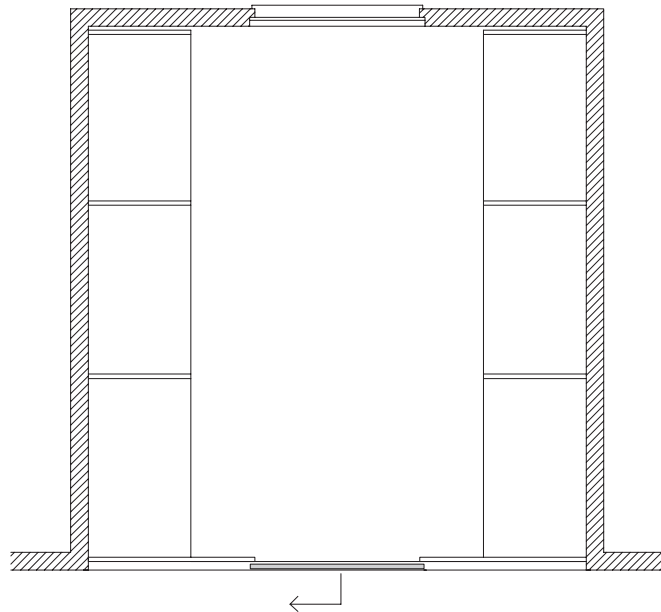

Strutture armadio prof. cm. 58 con 2 fianchi  
in profondità superiore.  
1 porta scorrevole completa di binario.

**3**

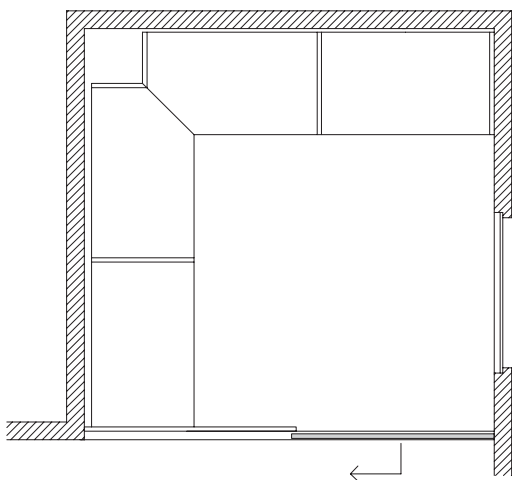

Struttura armadio angolare a "L"  
prof. cm. 58 con 1 fianco in profondità  
superiore.  
1 porta scorrevole completa di binario.

**4**

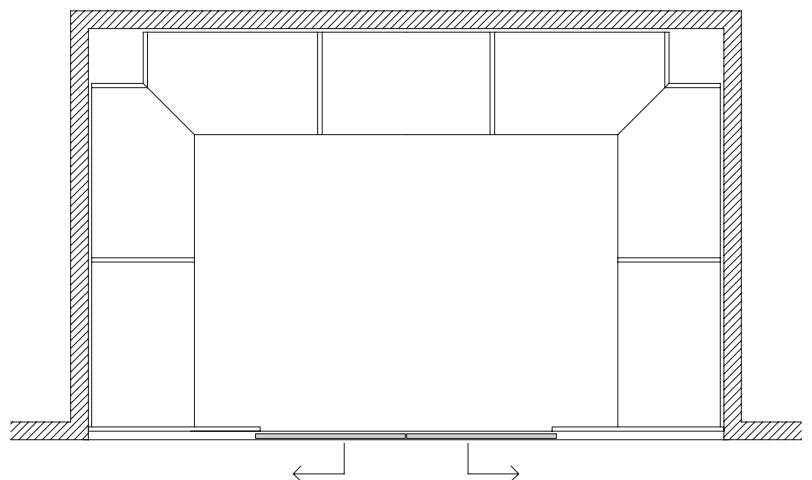

Struttura armadio angolare a "C" prof. cm. 58  
con 2 fianchi in profondità superiore.  
2 porte scorrevoli complete di binario

## FIANCO TERMINALE

Il fianco terminale è disponibile in profondità variabile da cm. 58 a cm. 120 nelle finiture nobilitato o laccato opaco. Tale misura è funzionale alle dimensioni della parete e al numero e alle dimensioni delle porte scorrevoli.

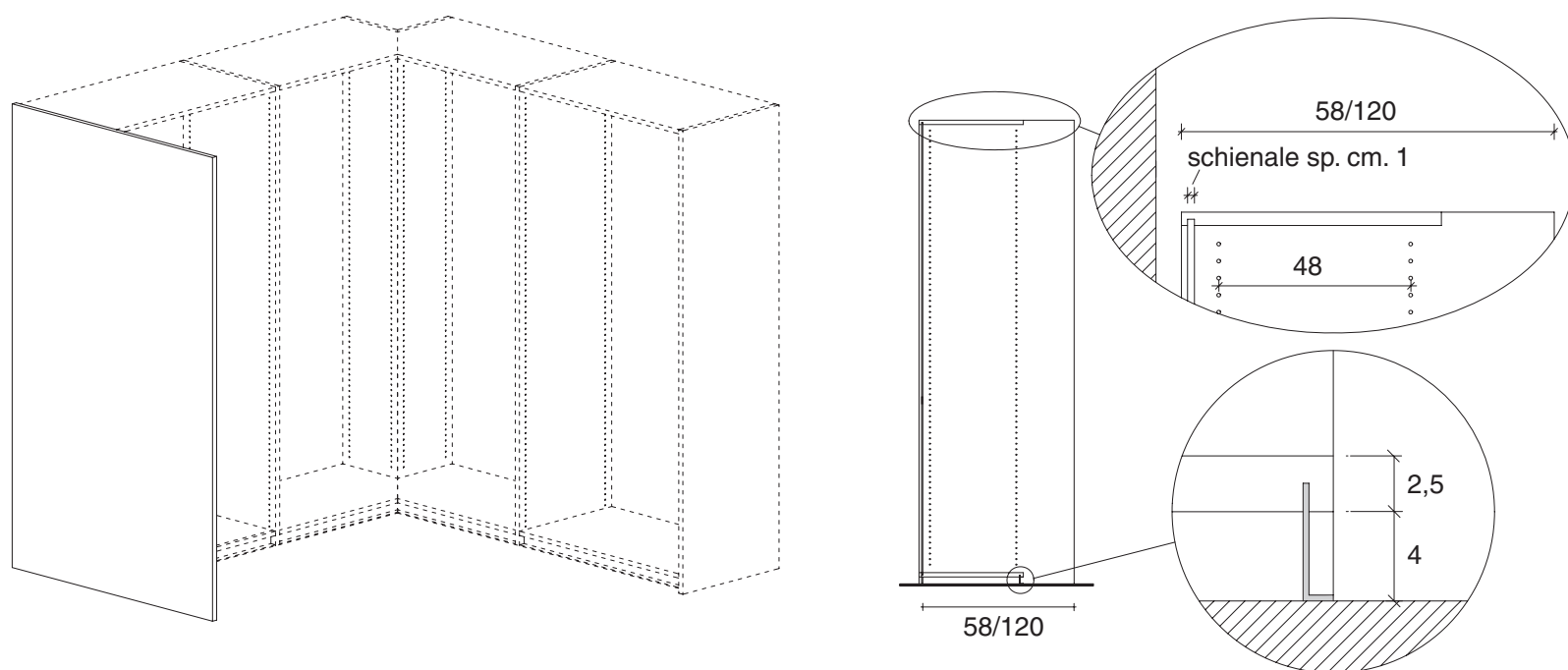

Per ovviare alle imperfezioni delle pareti e del pavimento, vengono forniti, in dotazione, due profili in alluminio cm. 2,7 sp. 0,3 da applicare con biadesivo sul fianco, da adattare sul posto in sede di montaggio.

SENZA PROFILI  
IN ALLUMINIO

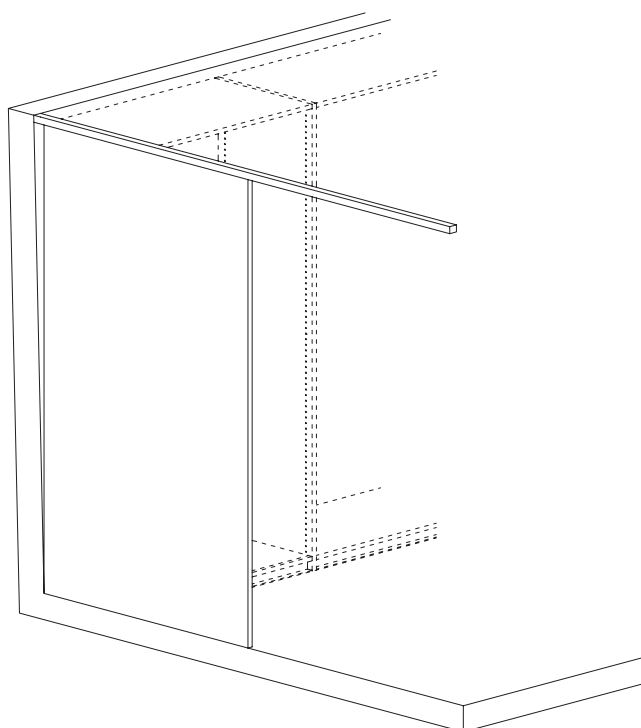

CON PROFILI  
IN ALLUMINIO

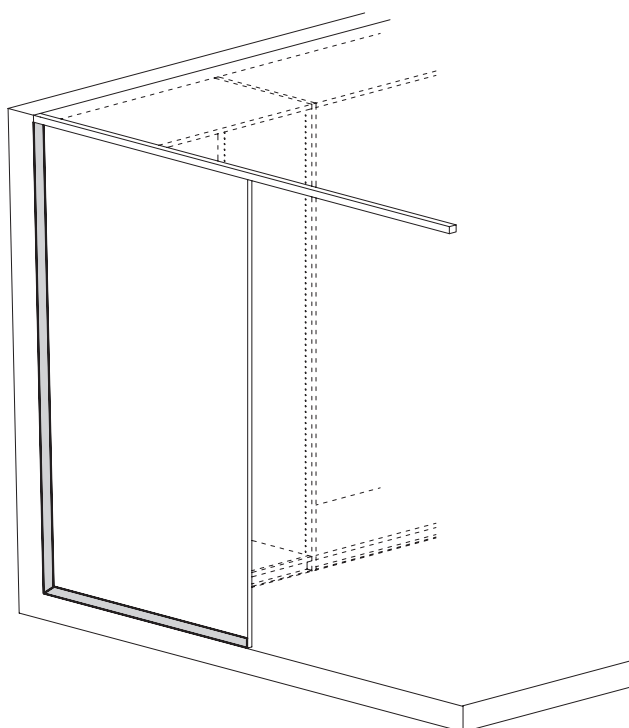

PROFILI IN AL-  
LUMINIO

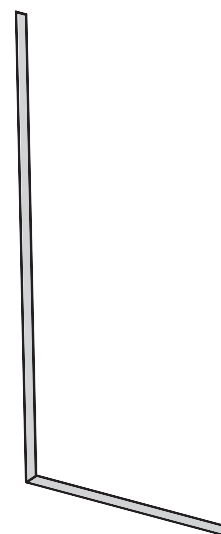

### FIANCO TERMINALE

In presenza di binario a 2 vie, con 2 o più porte, il fianco terminale sarà dotato di battuta laterale.

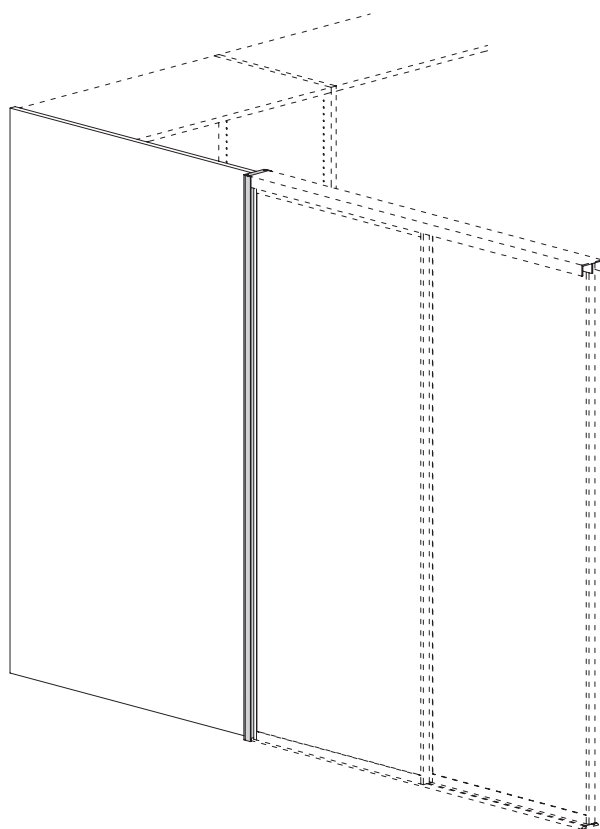

### FIANCO TERMINALE CON BATTUTA LATERALE



**IMPORTANTE: Verificare e segnalare la presenza di zoccolini e battiscopa non asportabili.**

**1**

Parete L. cm. 290 H. 285  
Struttura armadio L. cm. 286 H. 283,5

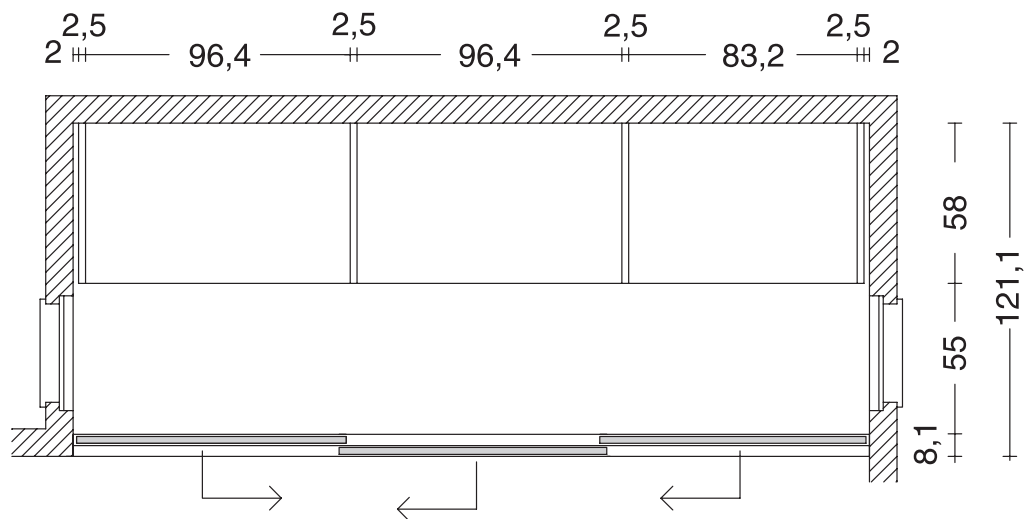

3 porte scorrevoli FLOOR mod. ROUND 34 L. cm. 98,8 H. 281  
Binari a 2 vie L. cm. 290 prof. cm. 8,1

**2**

Parete L. cm. 186 H. 270

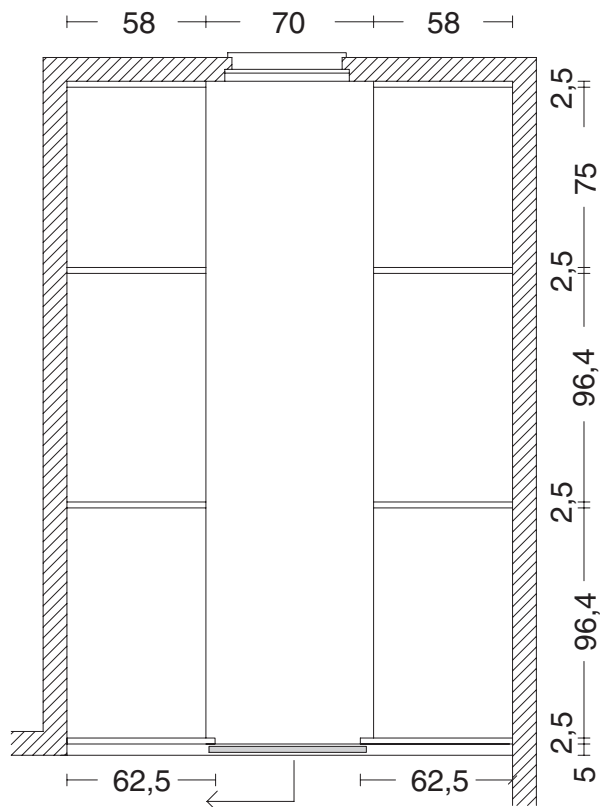

Parete L. cm. 283 H. 270  
Strutture armadio L. cm. 277,8 H. 268,5

1 porta scorrevole ARIA mod. BASIC 42 L. cm. 65 H. 264,7  
1 Binario 1 via L. cm. 186 prof. cm. 5

**IMPORTANTE: Verificare e segnalare la presenza di zoccolini e battiscopa non asportabili.**

**3a**

Parete L. cm. 226,4 H. 277  
 Struttura armadio L. cm. 191,9 H. 275,5

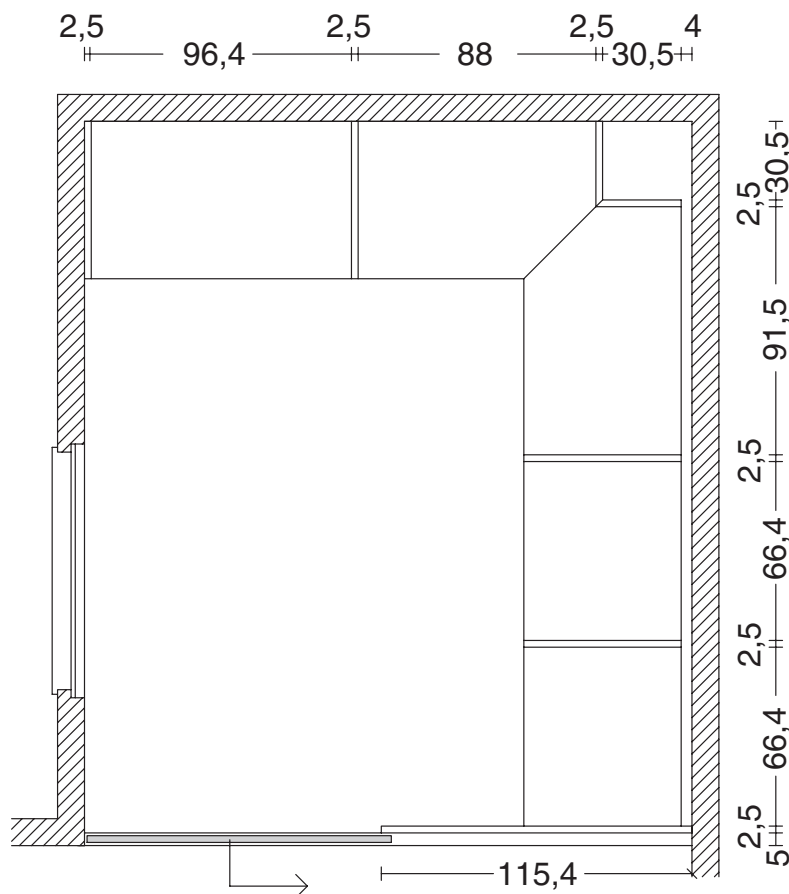

Parete L. cm. 270 H. 277  
 Struttura armadio  
 L. cm. 234,3 H. 275,5

1 porta scorrevole ARIA mod. OVAL 34 L. cm. 116 H. 271,7  
 1 Binario ARIA L. cm. 226,4 prof. cm. 5

**3b**

Parete L. cm. 327,3 H. 280  
 Struttura armadio L. cm. 292,8 H. 278,5

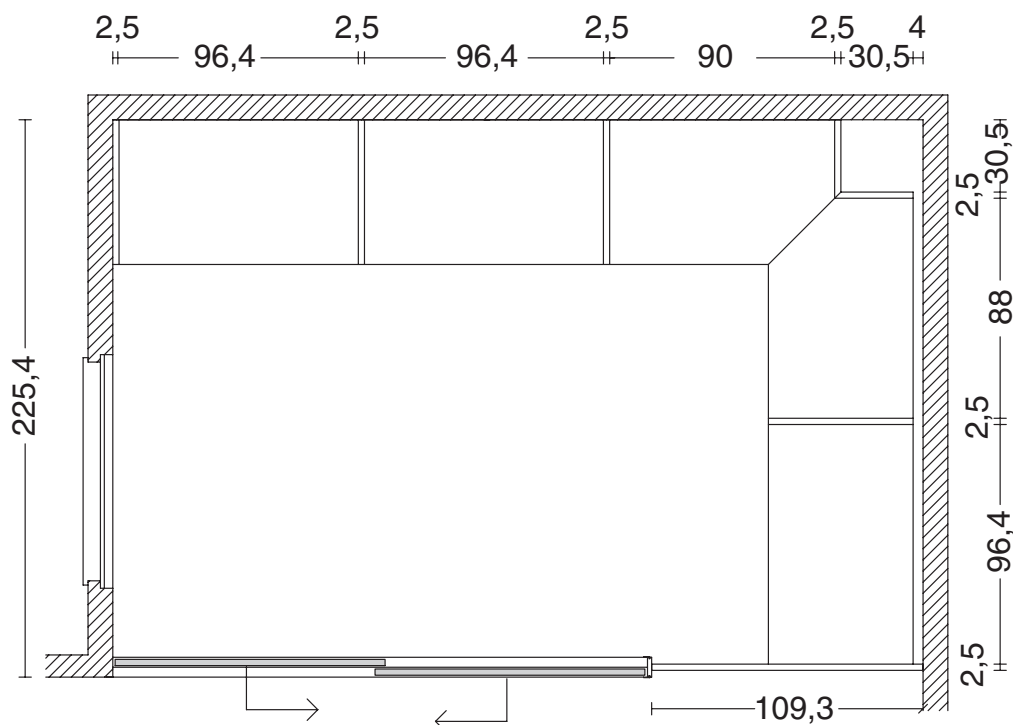

Parete L. cm. 222,4 H. 280  
 Struttura armadio  
 L. cm. 191,9 H. 278,5

2 porte FLOOR mod. SQUARE 34 L. cm. 110 H. 276  
 1 Binario 2 vie L. cm. 216,1 prof. cm. 8,1

**IMPORTANTE: Verificare e segnalare la presenza di zoccolini e battiscopa non asportabili.**

**4**

Parete L. cm. 359,4 H. 265  
Struttura armadio L. cm. 294,4 H. 263,5

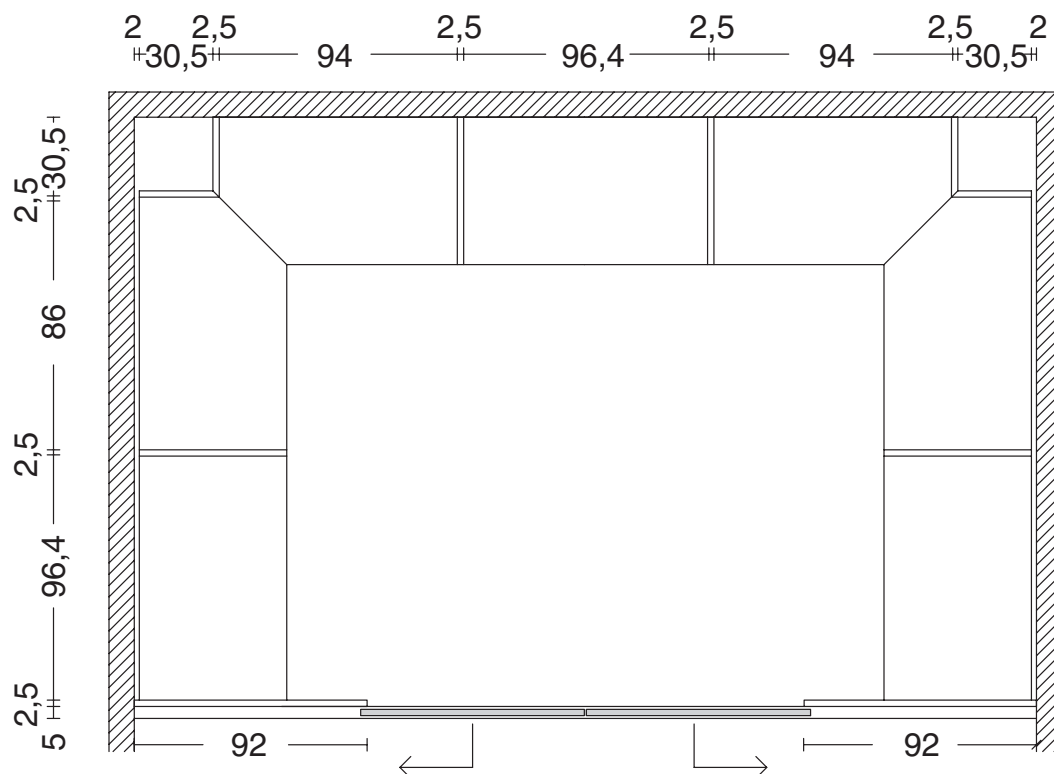

Parete L. cm. 225,4 H. 265  
Strutture armadio  
L. cm. 189,9 H. 263,5

2 porte scorrevoli ARIA mod. MINIMAL 42 L. cm. 89,7 H. 259,7  
1 Binario 1 via L. cm. 359,4 prof. cm. 5

## PIÙ IN ALTO DRESSING

Per semplificare l'uso del listino, proponiamo composizioni di strutture armadio attrezzate, complete di porte scorrevoli.

Le dimensioni delle porte in larghezza si riferiscono al mod. ROUND 34.

È possibile tuttavia utilizzare anche gli altri modelli, con il relativo calcolo delle quote da parte del ns. Ufficio Tecnico.

I prezzi si intendono riferiti a composizioni PIÙ' IN ALTO fino a H. cm. 270, con fianchi laterali nobilitato e battuta laterale grigio alluminio.

I prezzi delle porte si intendono comprensivi di binari FLOOR 34.

Parete L. cm. 195,4  
Struttura armadio L. cm. 160,9

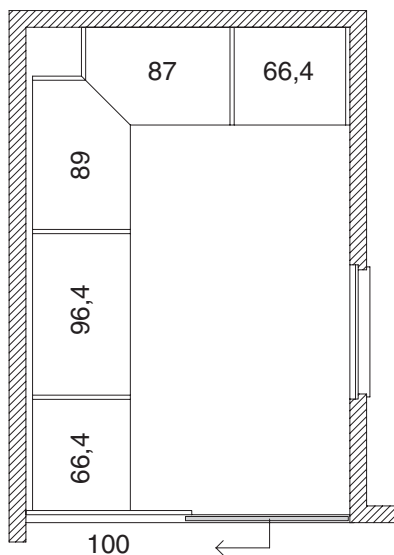

Parete L. cm. 296,5  
Struttura armadio  
L. cm. 261,8

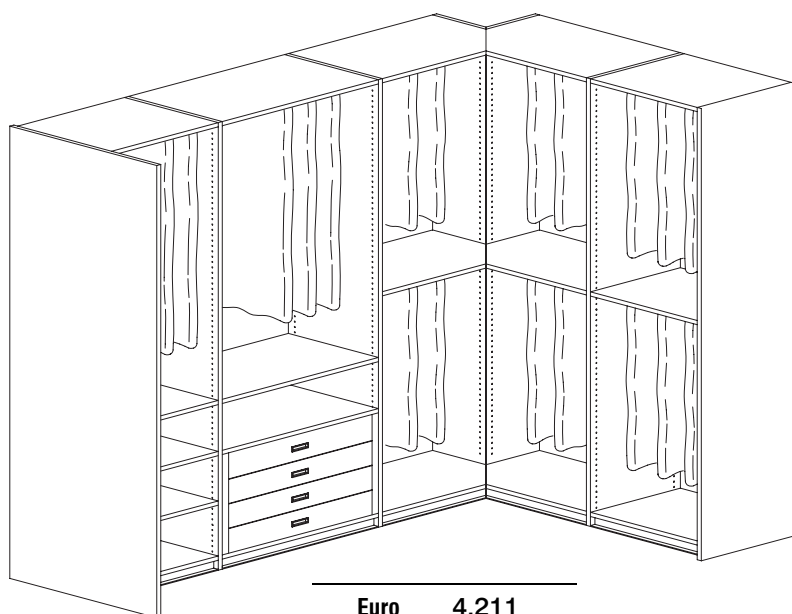

Euro 4.211

Binari L. cm. 195,4  
1 Porta L. cm. 98,6

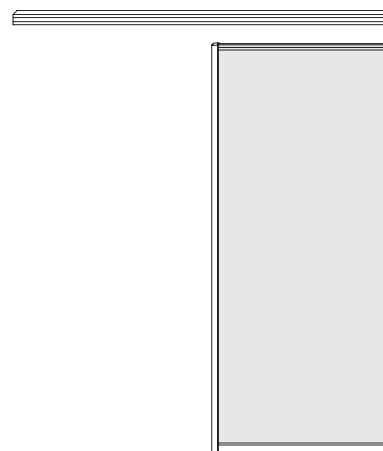

CAT. D Euro 1.291

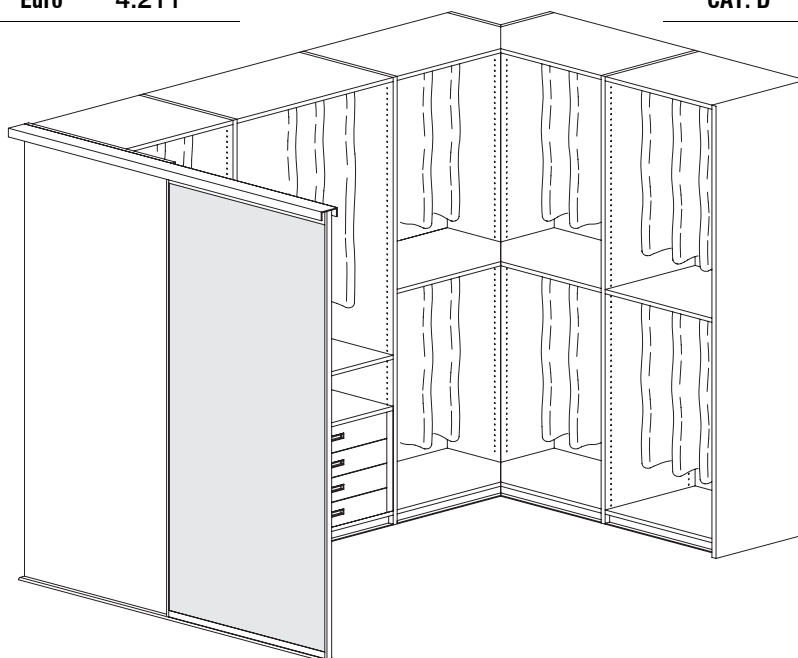

Euro 5.502

**AR200**

Parete L. cm. 183,5  
Struttura armadio L. cm. 179,5

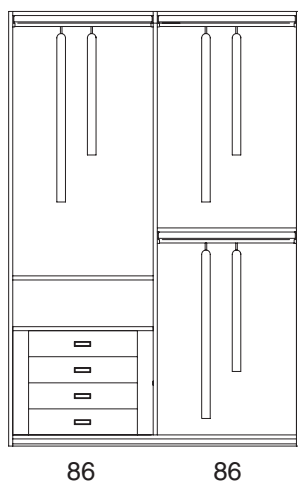
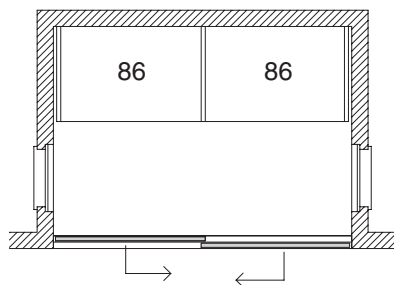

Euro 1.960

Binari L. cm. 183,5  
2 Porte L. cm. 93,4

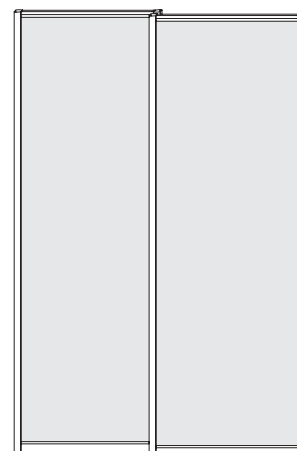

CAT. D Euro 2.401

**AR201**

Parete L. cm. 281,8  
Struttura armadio L. cm. 277,8

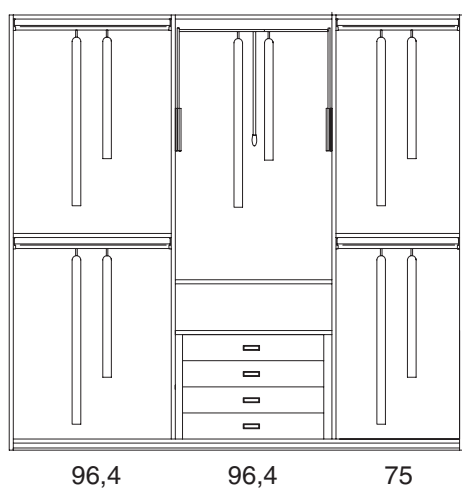
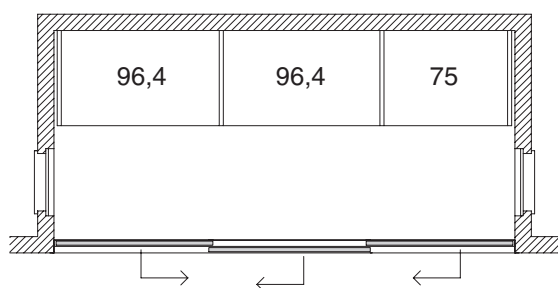

Euro 2.870

Binari L. cm. 281,8  
3 Porte L. cm. 96

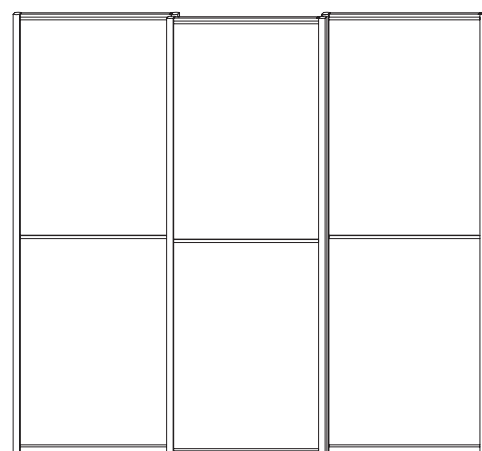

CAT. A Euro 2.985



**AR202**

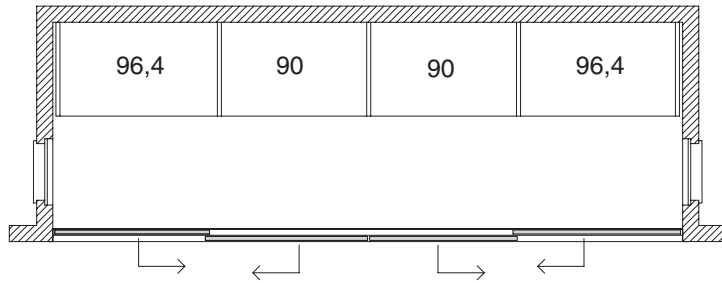

Parete L. cm. 389,3  
Struttura armadio L. cm. 385,3

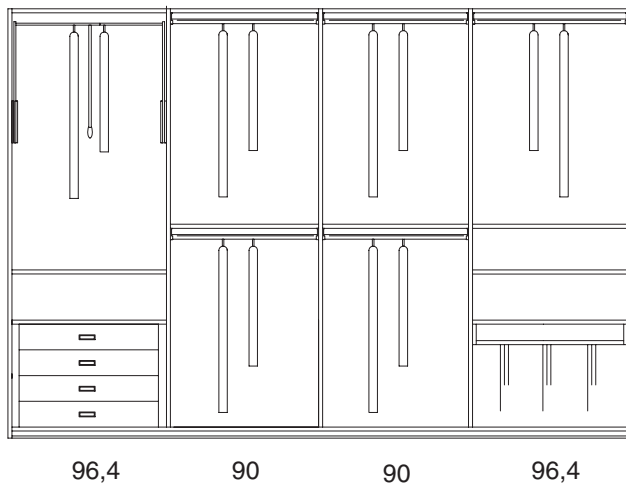

Euro 3.789

Binari L. cm. 389,3  
4 Porte L. cm. 99

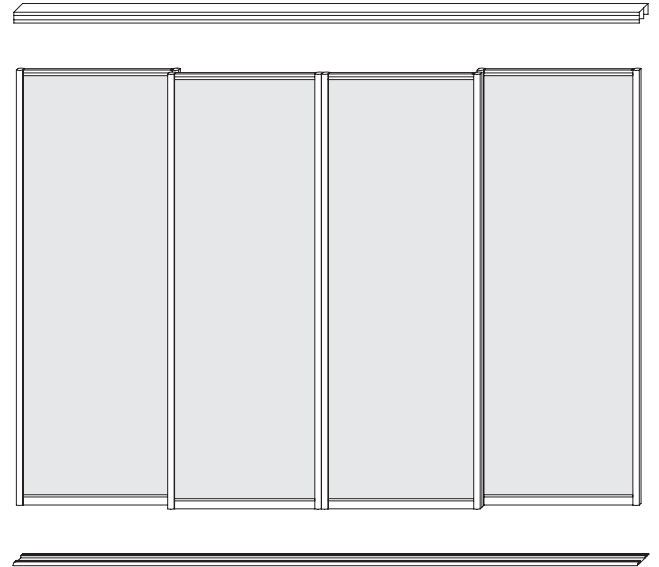

CAT. D Euro 4.826

**AR203**

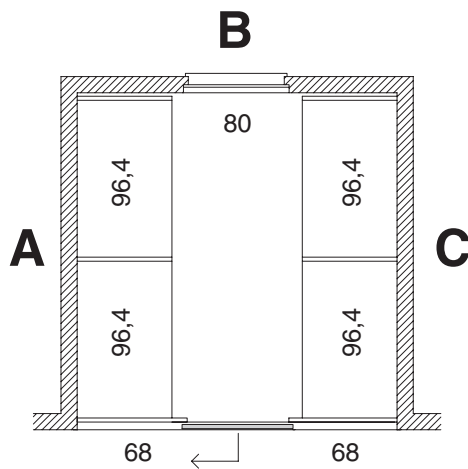

Parete A L. cm. 204,5  
Parete B L. cm. 196  
Parete C L. cm. 204,5  
Strutture armadio L. cm. 200,3

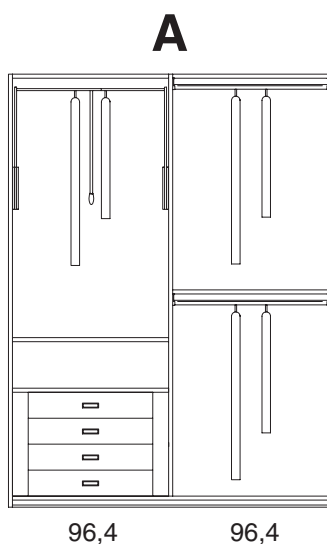

Euro 2.382

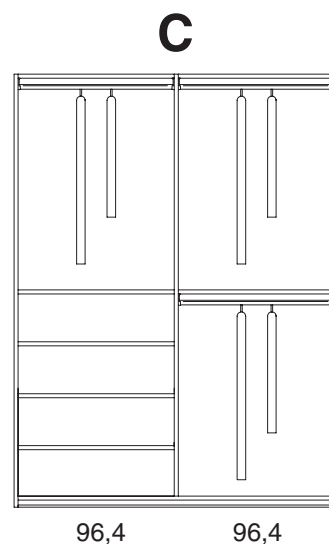

Euro 1.589

Binari L. cm. 196  
1 Porta L. cm. 66,4

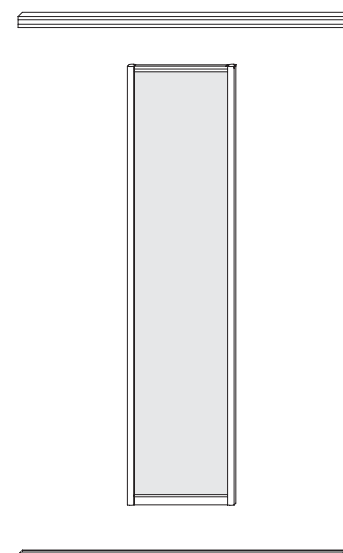

CAT. D Euro 1.176

AR204

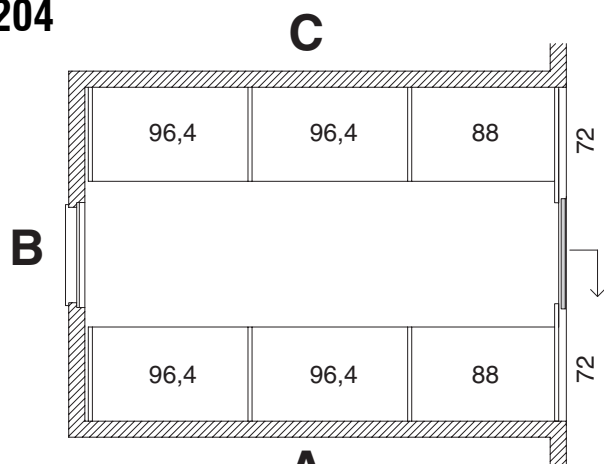

Parete A L. cm. 295  
 Parete B L. cm. 206  
 Parete C L. cm. 295  
 Strutture armadio L. cm. 290,8

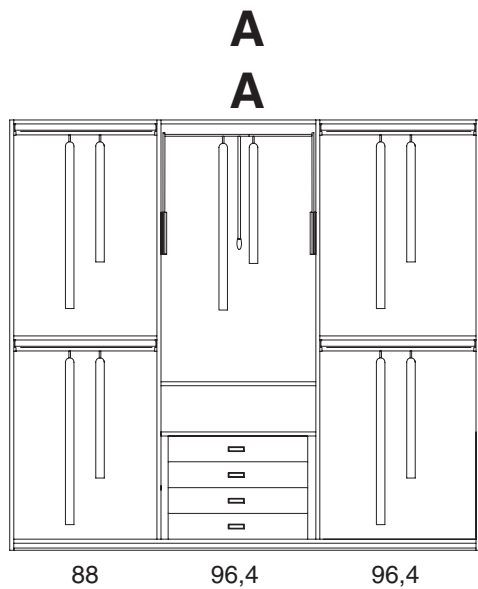

Euro 2.960

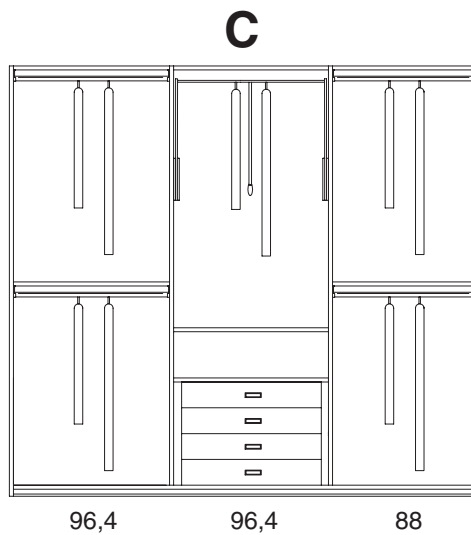

Euro 2.960

Binari L. cm. 206  
 1 Porta L. cm. 68,4

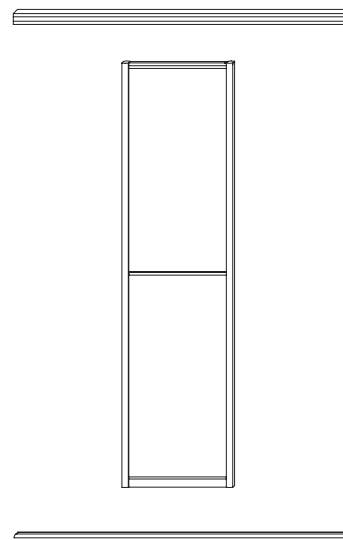

CAT. A Euro 1.038

AR205

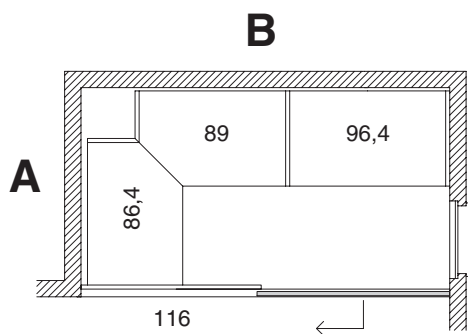

Parete A L. cm. 126,1  
 Parete B L. cm. 227,4  
 Struttura armadio A L. cm. 91,4  
 Struttura armadio B L. cm. 192,9

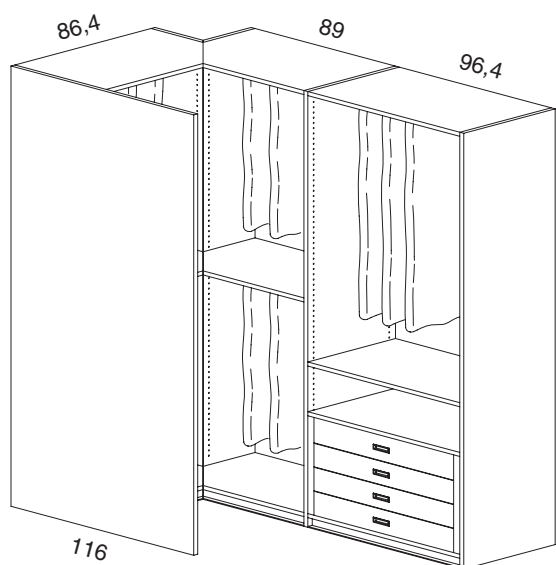

Euro 3.061

Binari L. cm. 227,4  
 1 Porta L. cm. 114,6

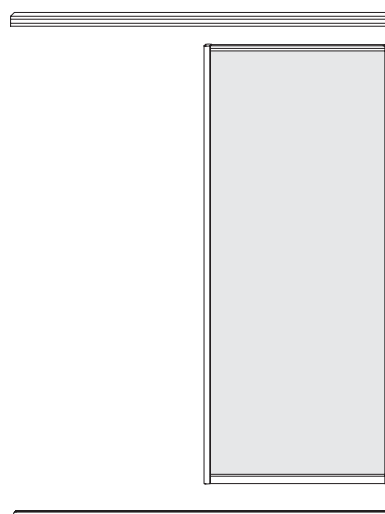

CAT. D Euro 1.439

**AR206**

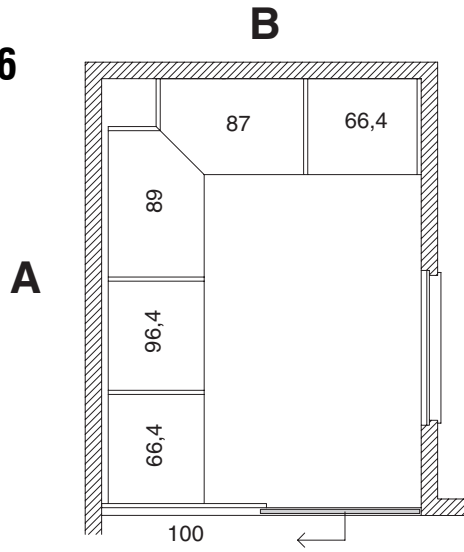

Parete A L. cm. 296,5  
 Parete B L. cm. 195,4  
 Struttura armadio A L. cm. 261,8  
 Struttura armadio B L. cm. 160,9

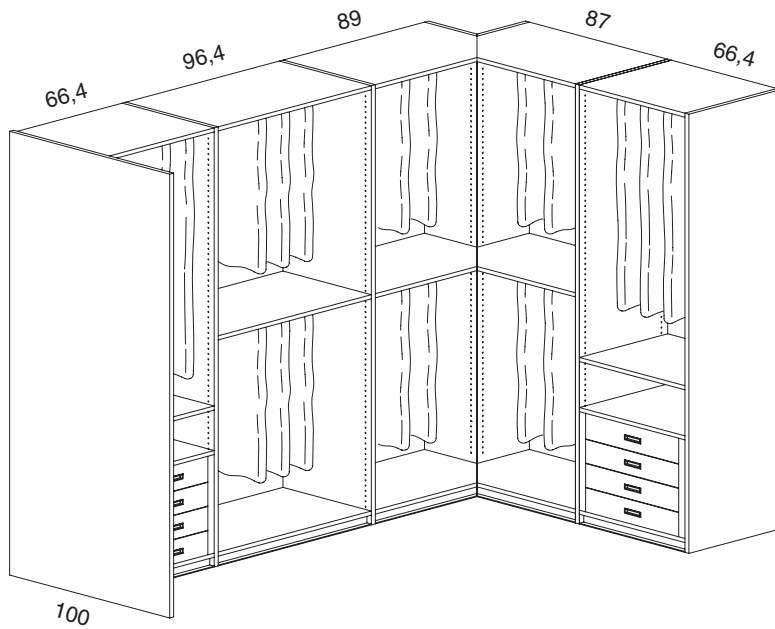

Euro 4.701

Binari L. cm. 195,4  
 1 Porta L. cm. 98,6

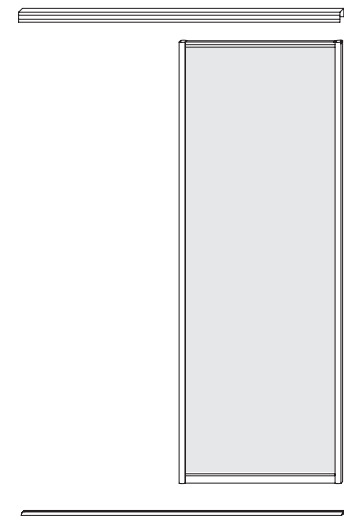

CAT. D Euro 1.291

**AR207**

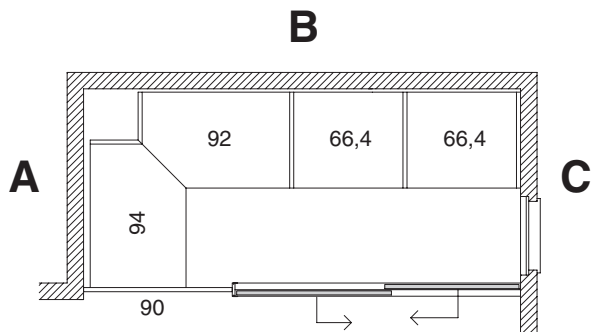

Parete A L. cm. 129,5  
 Parete B L. cm. 269,3  
 Parete C L. cm. 132,5  
 Struttura armadio A L. cm. 99  
 Struttura armadio B L. cm. 234,8

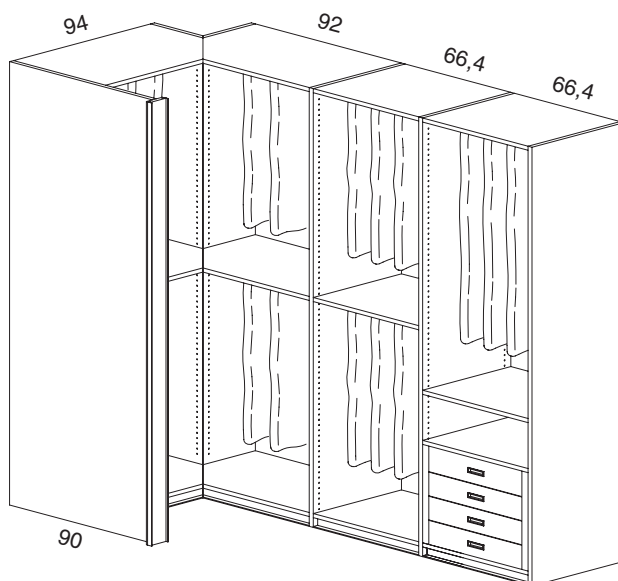

Euro 3.508

Binari L. cm. 177,4  
 2 Porte L. cm. 90,3

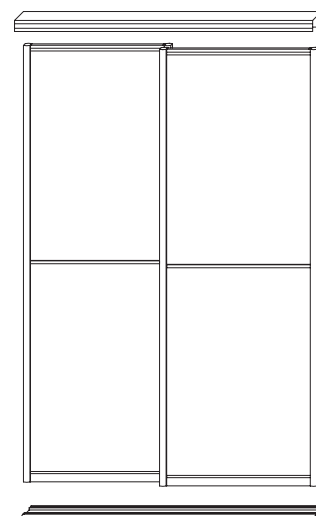

CAT. A Euro 2.100

AR208

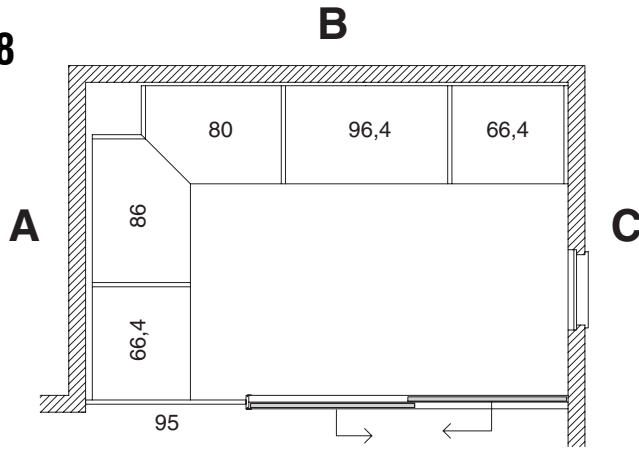

Parete A L. cm. 190,4  
 Parete B L. cm. 287,3  
 Parete C L. cm. 193,4  
 Struttura armadio A L. cm. 159,9  
 Struttura armadio B L. cm. 252,8

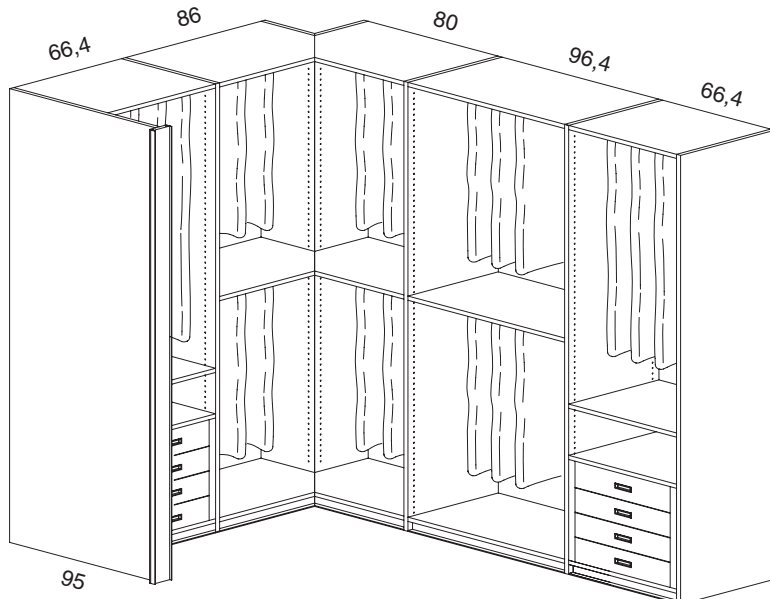

Euro 4.701

Binari L. cm. 190,4  
 2 Porte L. cm. 96,8

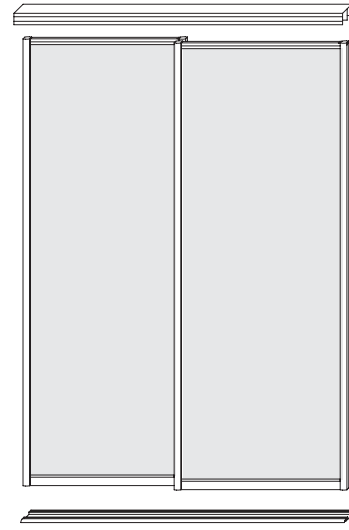

CAT. D Euro 2.529

AR209

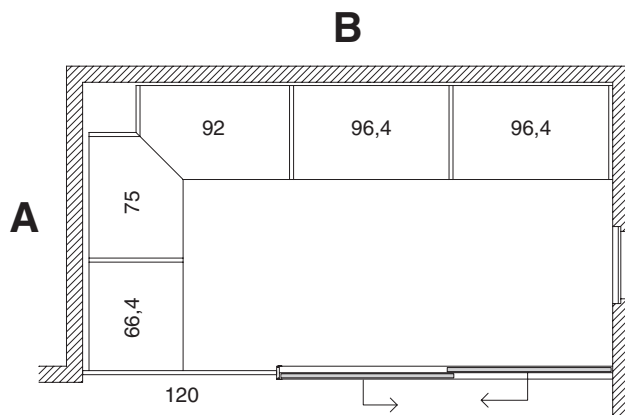

Parete A L. cm. 179,4  
 Parete B L. cm. 329,3  
 Parete C L. cm. 182,4  
 Struttura armadio A L. cm. 148,9  
 Struttura armadio B L. cm. 294,8

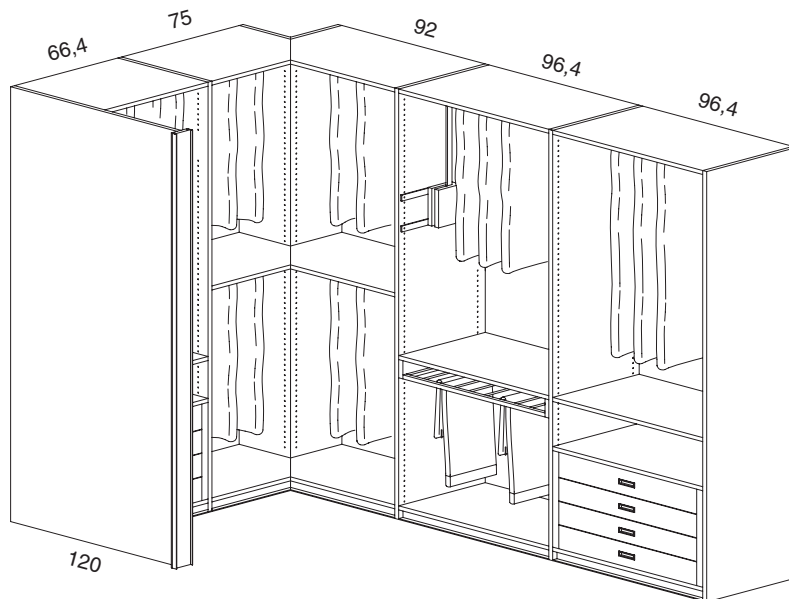

Euro 5.308

Binari L. cm. 207,4  
 2 Porte L. cm. 105,3

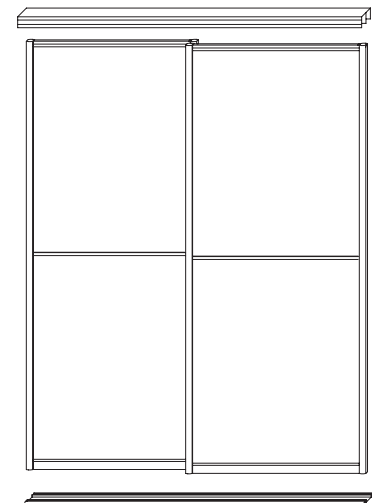

CAT. A Euro 2.129

AR210

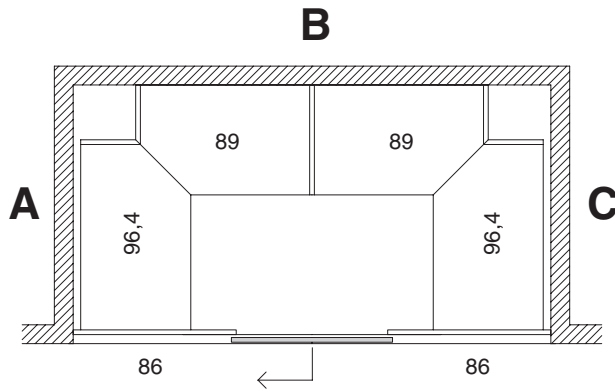

Parete A L. cm. 136,1  
 Parete B L. cm. 250,5  
 Parete C L. cm. 136,1  
 Struttura armadio A L. cm. 101,4  
 Struttura armadio B L. cm. 185,5  
 Struttura armadio C L. cm. 101,4

Binari L. cm. 250,5  
 1 Porta L. cm. 84,9

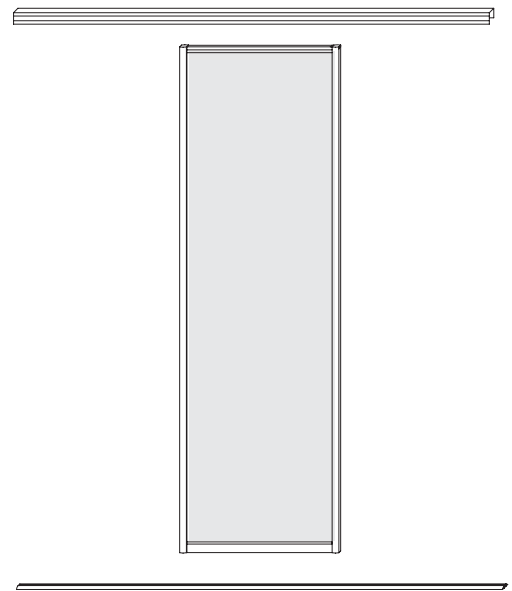
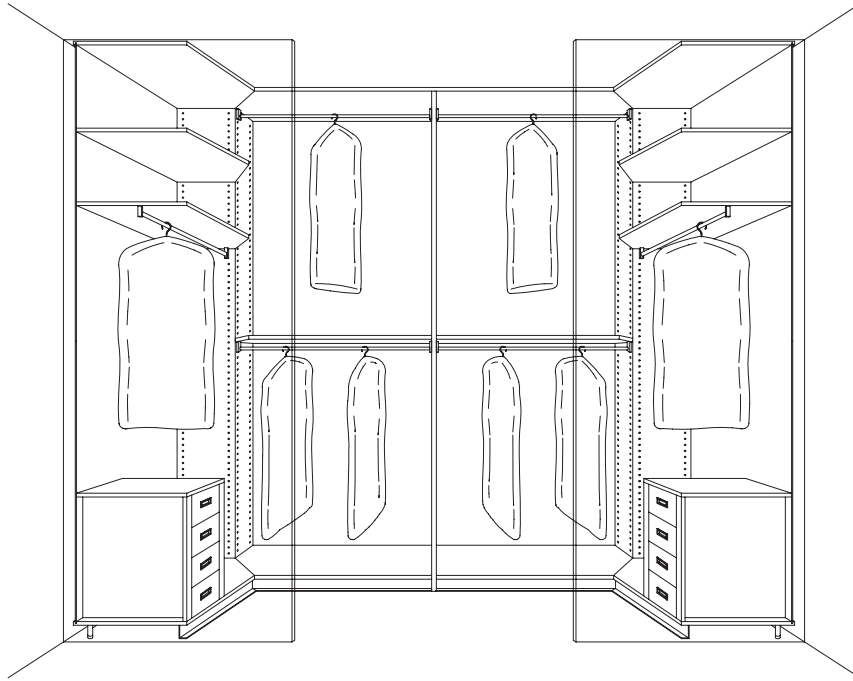

Euro 4.839

CAT. D Euro 1.227

AR211

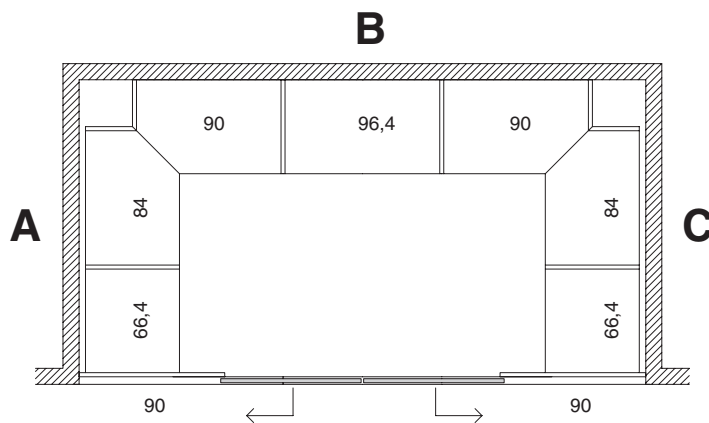

Parete A L. cm. 192,6  
 Parete B L. cm. 351,4  
 Parete C L. cm. 192,6  
 Struttura armadio A L. cm. 157,9  
 Struttura armadio B L. cm. 286,4  
 Struttura armadio C L. cm. 157,9

Binari L. cm. 351,4  
 2 Porte L. cm. 88,9

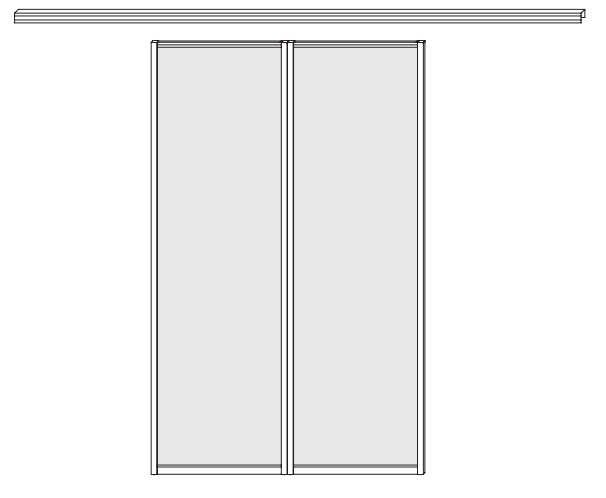
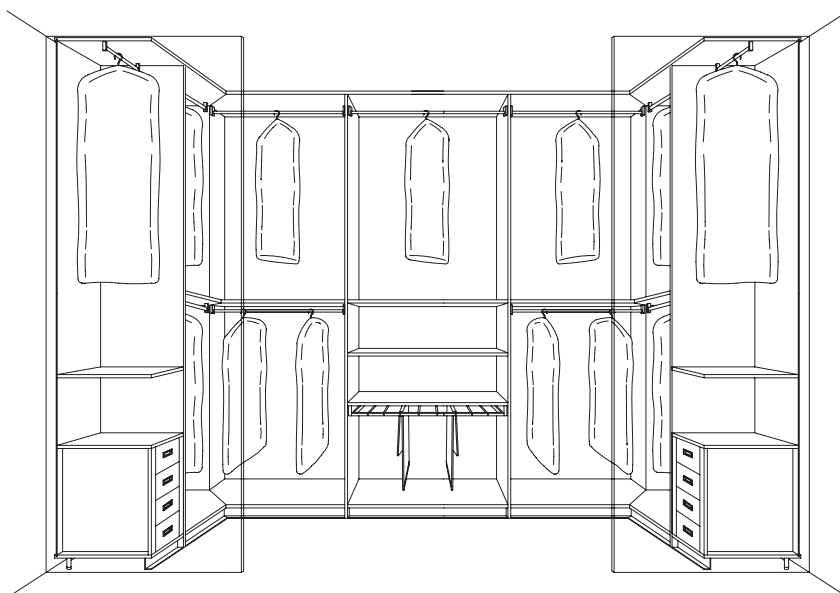

Euro 6.692

CAT. D Euro 2.545

AR212

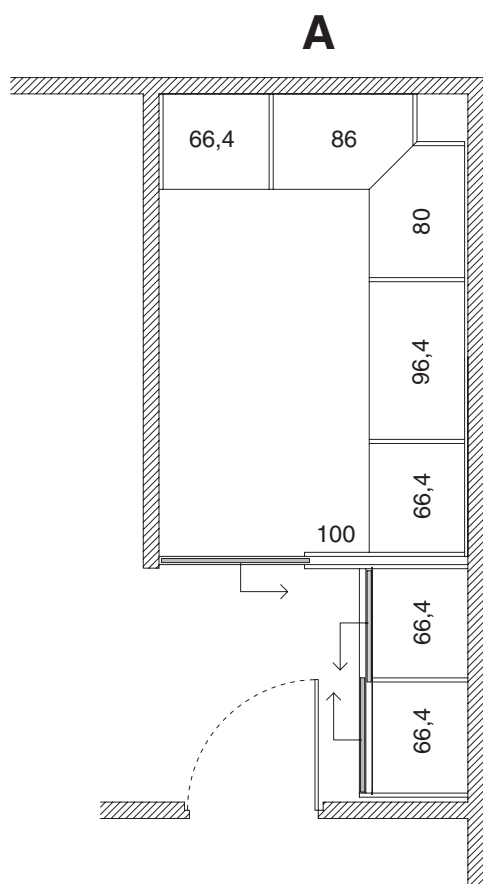

**A**  
 Parete A L. cm. 192,4  
 Parete B L. cm. 432,6  
**B**  
 Struttura armadio A L. cm. 159,9  
 Struttura armadio B1 L. cm. 252,8  
 Struttura armadio B2 L. cm. 140,3

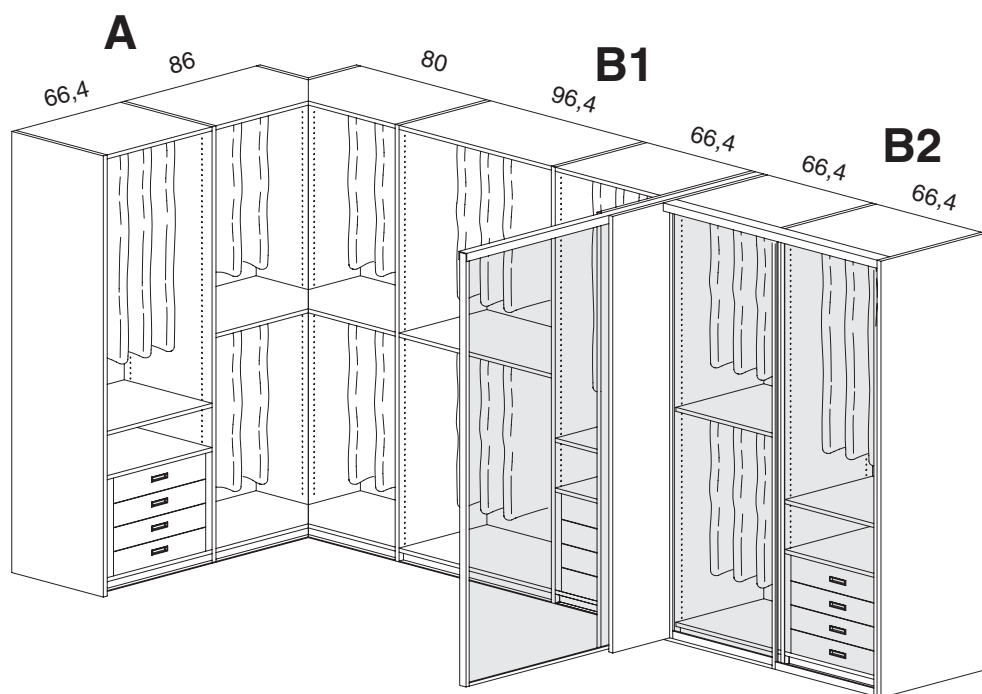

Binario ARIA L. cm. 192,4  
 1 Porta ARIA L. cm. 95,6

CAT. D Euro 1.278

**A B1**

Euro 4.701

**B2**

Euro 1.991

Binari FLOOR L. cm. 135,3  
 2 Porte FLOOR L. cm. 69,3

CAT. D Euro 2.118

## PIÙ IN ALTO MANSARDA

È possibile inserire la struttura armadio PIÙ IN ALTO anche in mansarda.

Data la complessità della situazione, per il montaggio della struttura armadio è necessario considerare una tolleranza di cm 3 per lato in larghezza, e di cm 2 in altezza.

La larghezza delle porte scorrevoli non corrisponde esattamente alla larghezza del modulo della struttura armadio corrispondente. Si consiglia pertanto di usare porte in legno o in vetro con finitura specchio o laccato.

Le dimensioni delle porte in larghezza si riferiscono al mod. ROUND 34.

È possibile tuttavia utilizzare anche gli altri modelli, con il relativo calcolo delle quote da parte del ns. Ufficio Tecnico.

I prezzi si intendono riferiti a composizioni PIU' IN ALTO fino a H. cm. 270, con fianchi terminali nobilitato.

I prezzi delle porte si intendono comprensivi di binari.

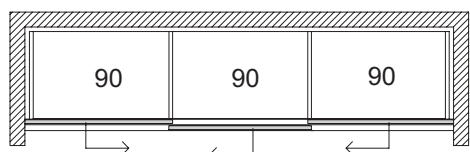
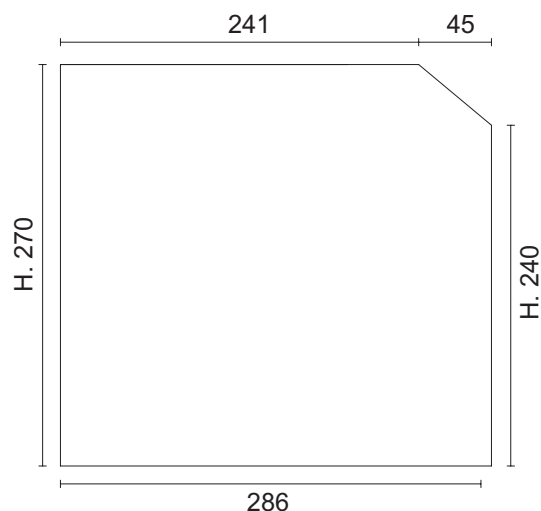

Struttura armadio da muro a muro  
con fianchi prof. cm. 58

Struttura armadio	<b>Euro</b>	<b>2.427</b>
Porte <b>Cat. D</b> e binari	<b>Euro</b>	<b>3.979</b>
Totale composizione	<b>Euro</b>	<b>6.405</b>

Parete L. cm. 286  
Struttura armadio L. cm. 280

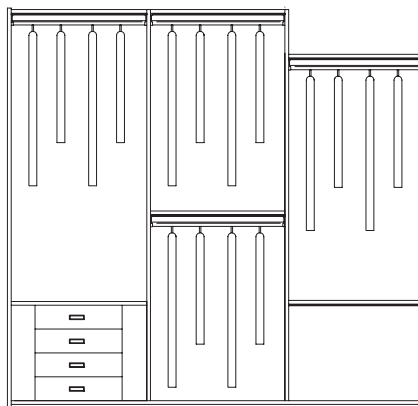

Binari superiori L. cm. 301  
con 3 tagli fuori squadra

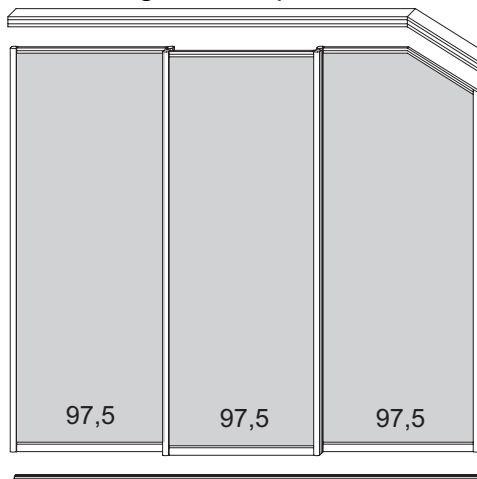

Binario inferiore L. cm. 286

## PIÙ IN ALTO MANSARDA

Per consentire il fissaggio del binario per lo scorrimento della porta inclinata, è indispensabile l'allineamento dei ripiani nei due moduli interessati all'abbassamento del soffitto. Il fianco interno tra i due moduli è oggetto di una pantografatura per il fissaggio del binario.

### AR213

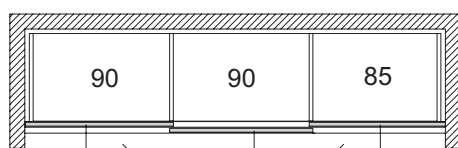
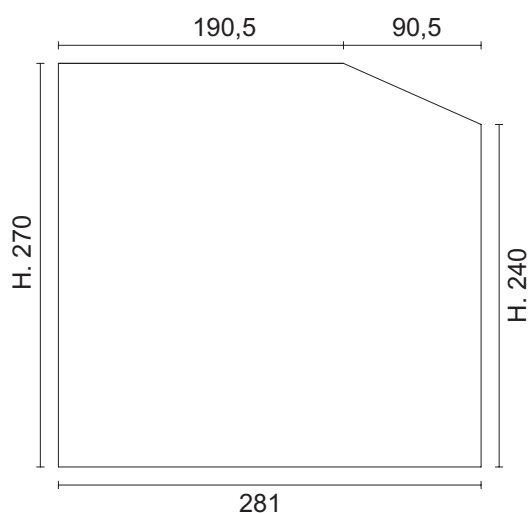

Struttura armadio da muro a muro con fianchi prof. cm. 58

Struttura armadio	<b>Euro</b>	<b>2.489</b>
Porte <b>Cat. D</b> e binari	<b>Euro</b>	<b>4.211</b>
<b>Totale composizione</b>	<b>Euro</b>	<b>6.696</b>

Parete L. cm. 281  
Struttura armadio L. cm. 275

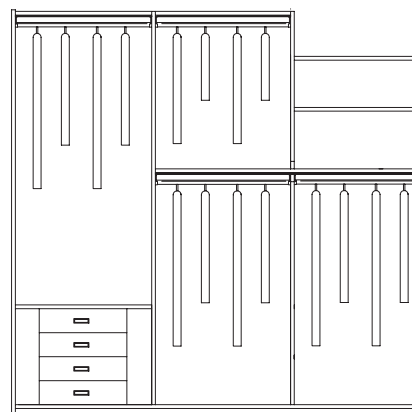

Binario per scorrimento porta inclinata

Binari superiori L. cm. 286 con 3 tagli fuori squadra

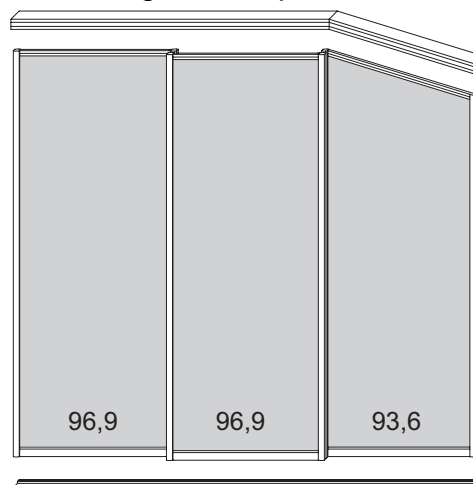

Binario inferiore L. cm. 281

### AR214

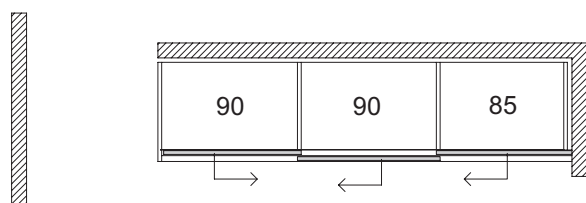
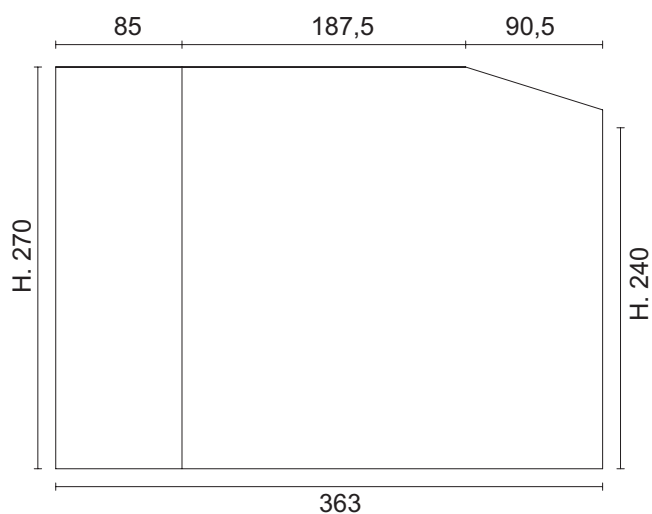

Struttura armadio con fianco laterale sx a vista prof. cm. 66,4

Struttura armadio	<b>Euro</b>	<b>2.532</b>
Porte <b>Cat. D</b> e binari	<b>Euro</b>	<b>4.207</b>
<b>Totale composizione</b>	<b>Euro</b>	<b>6.736</b>

Parete L. cm. 363  
Struttura armadio L. cm. 275

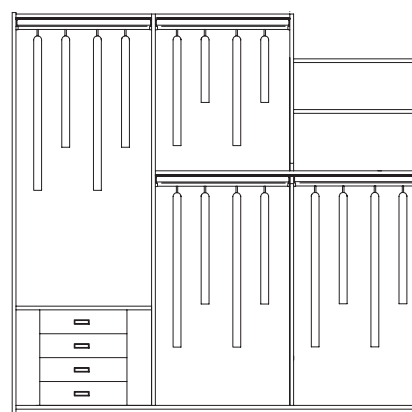

Binario per scorrimento porta inclinata

Binari superiori L. cm. 280 con 3 tagli fuori squadra

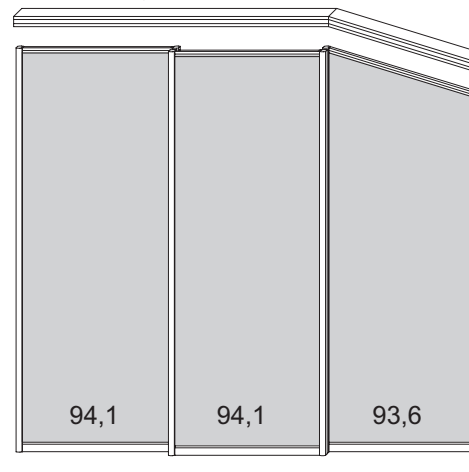

Binario inferiore L. cm. 275,5



# PIÙ IN ALTO AERO

Per contenere i costi e sfruttare al centimetro lo spazio dedicato all'appenderia, è possibile mixare le colonne dell'armadio PIÙ IN ALTO con semplici ripiani e canne appendiabiti da fissare a muro.

Le porte scorrevoli, essendo svincolate dalla struttura armadio, possono essere realizzate nella tipologia FLOOR con binari superiore ed inferiore, o ARIA con binario superiore, compatibilmente con il modello della porta ed al contesto.

**1**

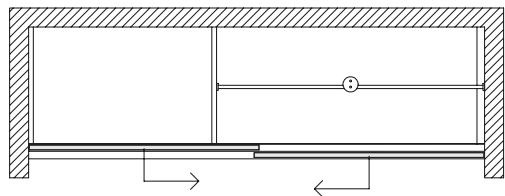

Struttura armadio prof. cm. 58  
1 ripiano 2 canne appendiabiti  
2 porte scorrevoli complete di binario

**2**

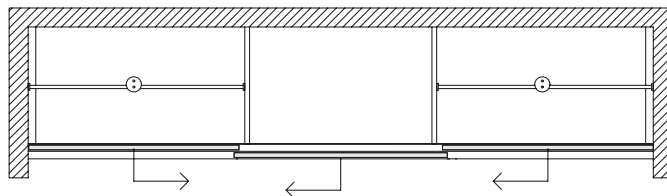

Struttura armadio prof. cm. 58  
2 ripiani 4 canne appendiabiti  
3 porte scorrevoli complete di binario

ESEMPIO PARETE L. cm. 242

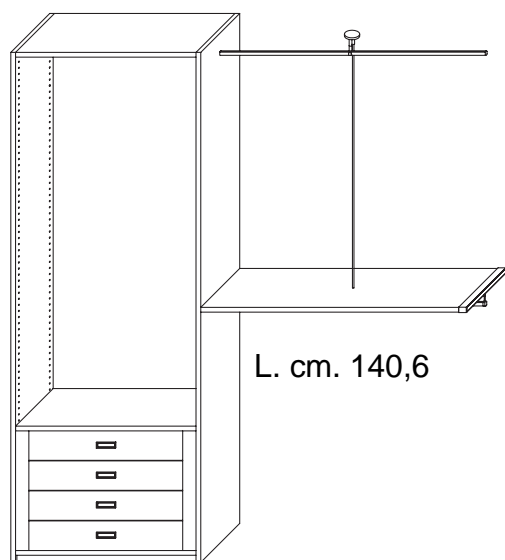

L. cm. 101,4

ESEMPIO PARETE L. cm. 330

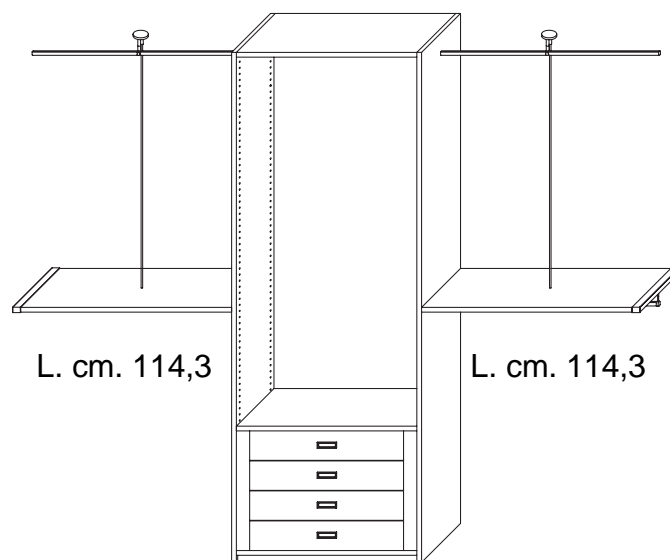

L. cm. 101,4

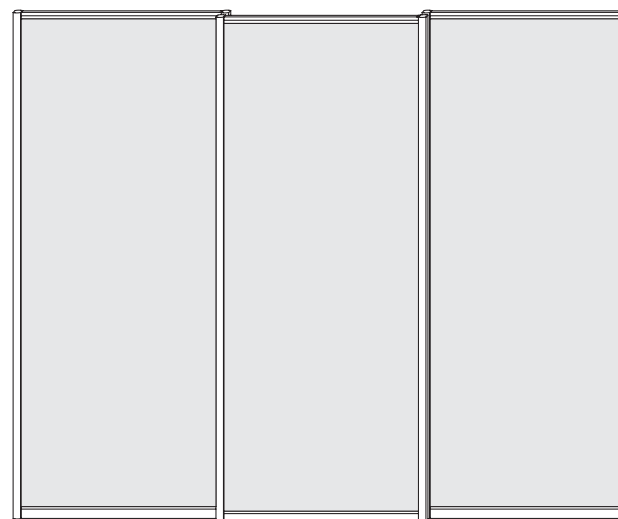
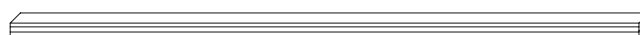
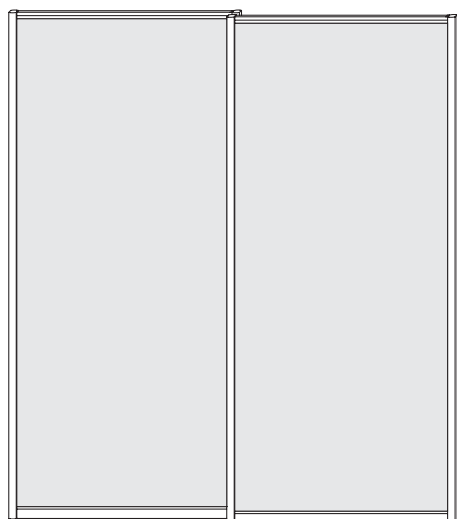
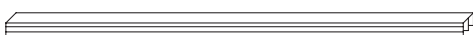

## STRUTTURE ARMADIO

L. 56,4  
prof. 58

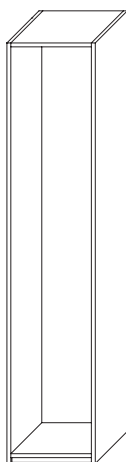

L. 71,4  
prof. 58



L. 101,4  
prof. 58

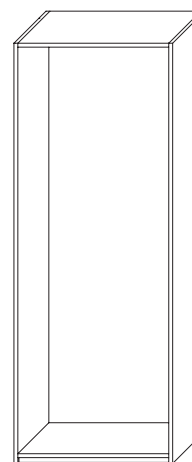

fino a H. 240	<b>AR300</b>	564	<b>AR303</b>	588	<b>AR306</b>	617
da H. 241 a H. 270	<b>AR301</b>	602	<b>AR304</b>	626	<b>AR307</b>	663
da H. 271 a H. 300	<b>AR302</b>	640	<b>AR305</b>	664	<b>AR308</b>	707

## CANNE APPENDIABILI PER STRUTTURA ARMADIO

L. 51,4

L. 66,4

L. 96,4



<b>AR100</b>	19	<b>AR101</b>	20	<b>AR102</b>	21
--------------	----	--------------	----	--------------	----

## APPENDIABILI SALISCENDI PER STRUTTURA ARMADIO - Portata max. kg. 10

L. 51,4

L. 66,4

L. 96,4

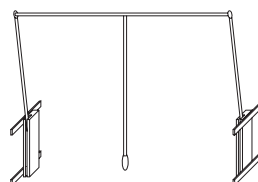
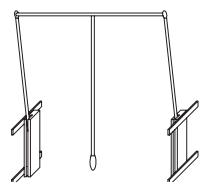
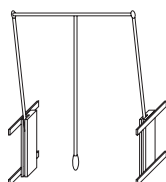

<b>AR104</b>	326	<b>AR105</b>	326	<b>AR106</b>	326
--------------	-----	--------------	-----	--------------	-----

## RIPIANI PER STRUTTURA ARMADIO sp. 2,5 prof. 56,3

L. 51,4

L. 66,4

L. 96,4

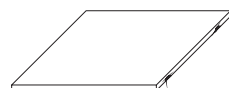
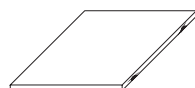

<b>AR107</b>	51	<b>AR108</b>	54	<b>AR109</b>	61
--------------	----	--------------	----	--------------	----

## RIPIANI PER STRUTTURA ARMADIO sp. 2,5 prof. 56,3 con canna appendiabiti

L. 51,4

L. 66,4

L. 96,4



<b>AR111</b>	67	<b>AR112</b>	73	<b>AR113</b>	80
--------------	----	--------------	----	--------------	----

# PIÙ IN ALTO AERO

## ATTREZZATURE PER STRUTTURA ARMADIO

### PORTAPANTALONI

ad estrazione totale con  
BLUMOTION L. 96,4 P. 56,3

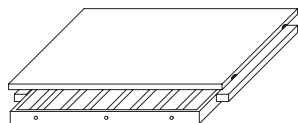

AR119 302

### RIPIANO

con piano scrittoio ad estrazione  
totale con BLUMOTION  
L. 96,4 P. 56,3

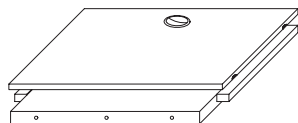

AR12120 346

### PORTACAMICIE

L. 96,4 H. 35 P. 51

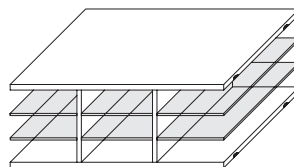

AR12121 361

## CASSETTIERE INTERNE P. 56,3 PER STRUTTURA ARMADIO

L. 51,4 - H. 66,7

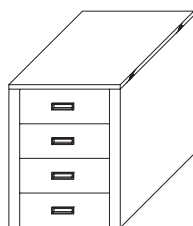

AR120 600

L. 51,4 - H. 66,7

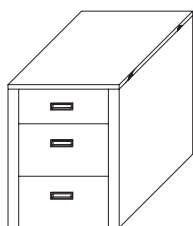

AR121 537

L. 51,4 - H. 66,7

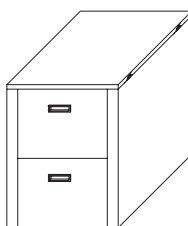

AR122 456

L. 66,4 - H. 66,7



AR124 633

L. 66,4 - H. 66,7



AR125 567

L. 66,4 - H. 66,7

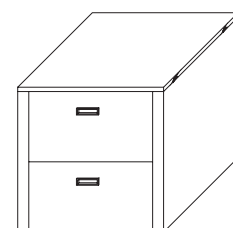

AR126 490

L. 96,4 - H. 66,7



AR128 670

L. 96,4 - H. 66,7



AR129 604

L. 96,4 - H. 66,7

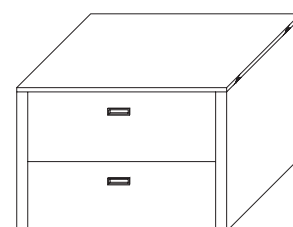

AR130 525

## CANNE APPENDIABILI con fissaggio tra armadio e parete

fino a L. 51,4



AR309 19

da L.51,5 a 66,4



AR310 20

da L.66,5 a 96,4



AR311 21

da L.96,5 a 145,8



AR312 26

# PIÙ IN ALTO AERO

## RIPIANI sp. 2,5 prof. 58 con fissaggio tra armadio e parete (aggiungere le staffe)

fino a L. 51,4

da L.51,5 a 66,4

da L.66,5 a 96,4

da L.96,5 a 145,8  
(aggiungere il tirante)

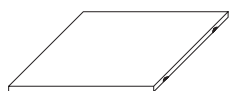
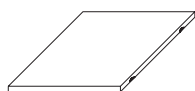

AR313	51	AR314	54	AR315	61	AR316	100
-------	----	-------	----	-------	----	-------	-----

## RIPIANI sp. 2,5 prof. 58 con canna appendiabiti

fino a L. 51,4

da L.51,5 a 66,4

da L.66,5 a 96,4

da L.96,5 a 145,8  
(aggiungere il tirante)

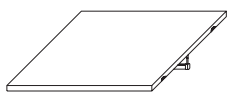
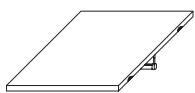

AR317	67	AR318	73	AR319	80	AR320	124
-------	----	-------	----	-------	----	-------	-----

### STAFFE PER RIPIANI

### TIRANTE PER CANNE APPENDIABITI E RIPIANI DA L. 96,5 A 145,8

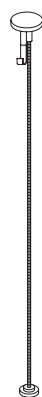
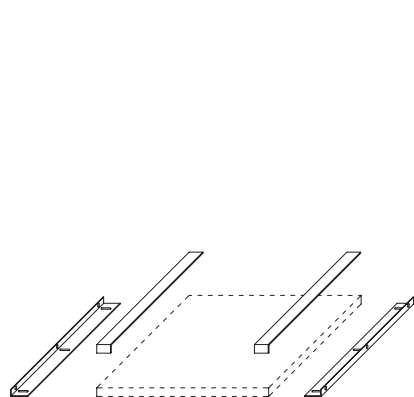

AR321	52 CAD.	AR322	166
-------	---------	-------	-----

**1**

**2**

**3**

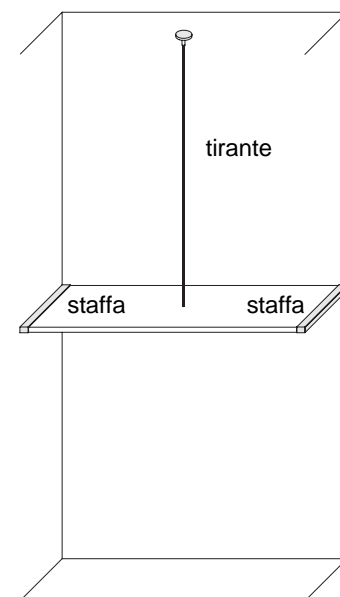
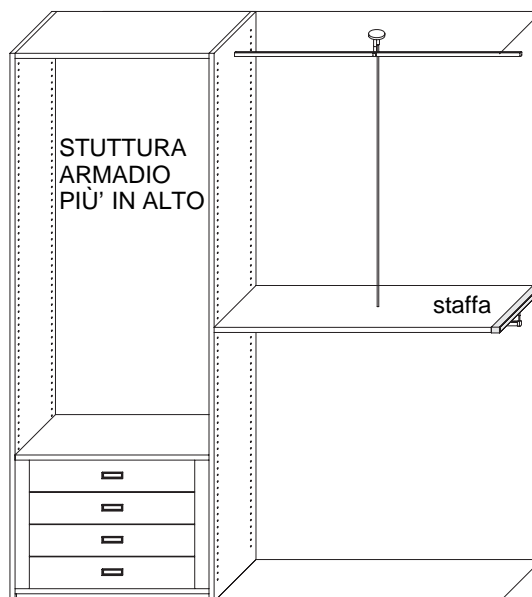
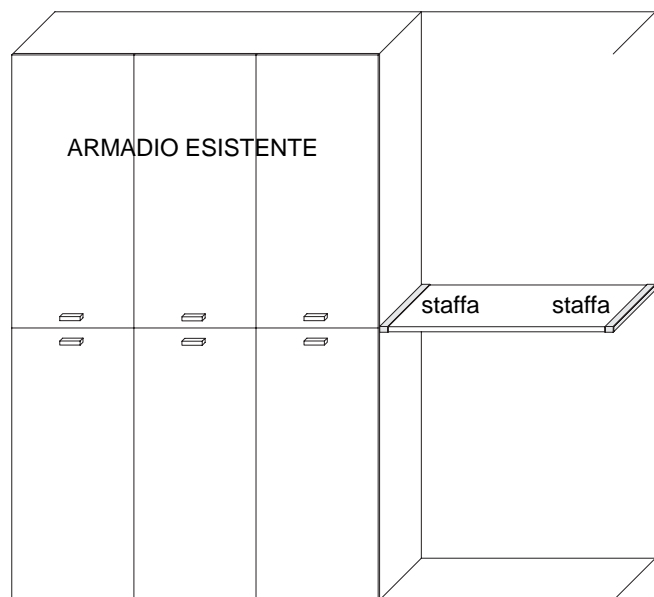

# PIÙ IN ALTO AERO

## CASSETTIERE SU RUOTE ad estrazione totale con BLUMOTION H. 72,7 P. 56

L. 45

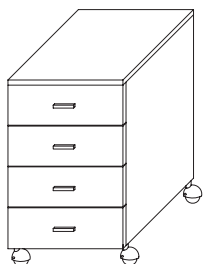

L. 60

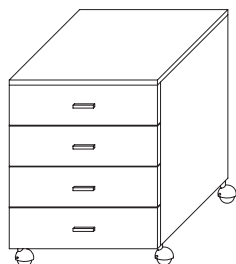

L. 90

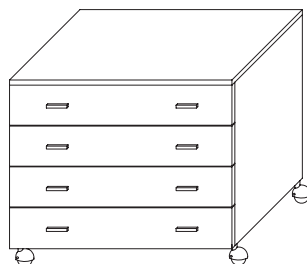

AR323 688

AR324 725

AR325 777

## ATTREZZATURE da fissare a parete con viti

mensola  
sp. 2,5 p. 33  
al metro lineare



coppia  
reggimensola  
color grigio



pomolo  
appendiabiti



svuotatasche  
L. 30 H. 15 P. 10

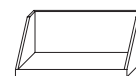

AR326 84

AR327 21

AR328 17

AR329 51

staffa appendiabiti  
L. 28



portacravatte  
L. 50 h. 9



portacinture  
L. 50 h. 9



portagonne  
portapantaloni  
L. 50 h. 20

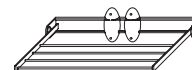

AR330 76

AR331 81

AR332 140

AR333 148

portascarpe estensibile  
in filo di ferro P.20  
L. 67/115



Vaschetta per  
portascarpe  
estensibile  
(facoltativo)

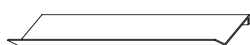

portascarpe  
L. 48 H. 70 P. 22

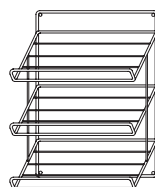

specchio  
L. 36 H. 160



AR334 47

AR335 70

AR336 84

AR337 94

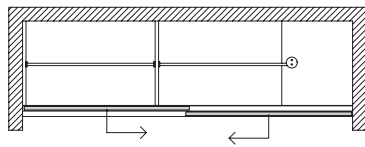

L. cm. 240

**AR338**

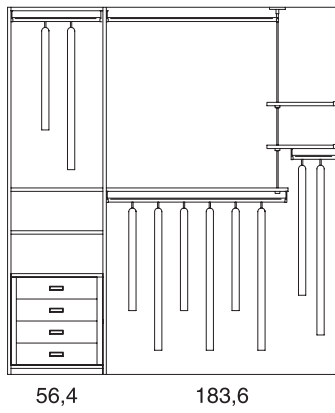

56,4      183,6

**Euro 1.838**

Binari L. cm. 240  
Porta L. cm. 121,6

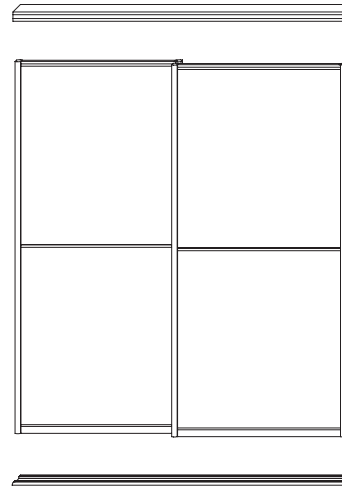

**CAT. A Euro 2.151**

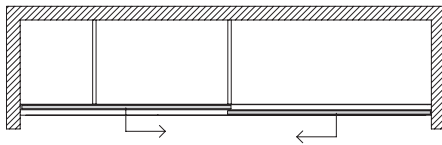

L. cm. 291,6

**AR339**

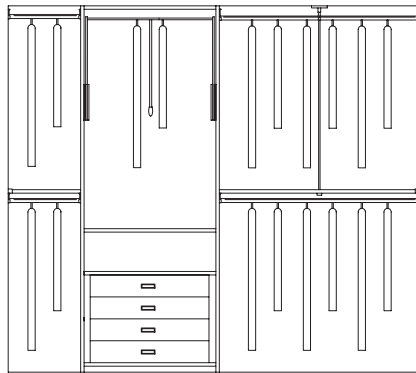

44,4      101,4      145,8

**Euro 2.207**

Binari L. cm. 291,6  
Porta Maxi Floor L. cm. 147,4

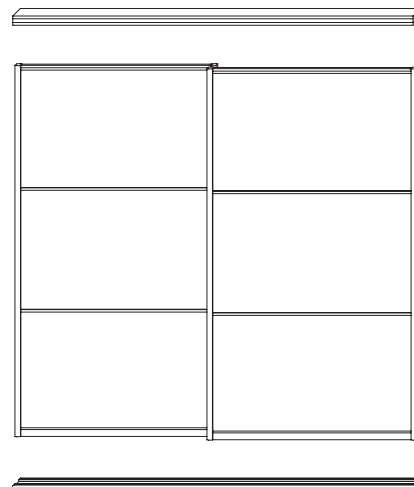

**CAT. A Euro 2.513**



## BOISERIE

La cabina armadio BOISERIE è un sistema alternativo al solito armadio.

La cabina armadio BOISERIE è costituita da pannelli sp. cm. 1,8 a muro regolabili su tre assi, attrezzati con ripiani e canne appendiabiti fissati tramite supporti con innesto.

Completano il programma una serie di cassettiere su ruote e accessori vari.

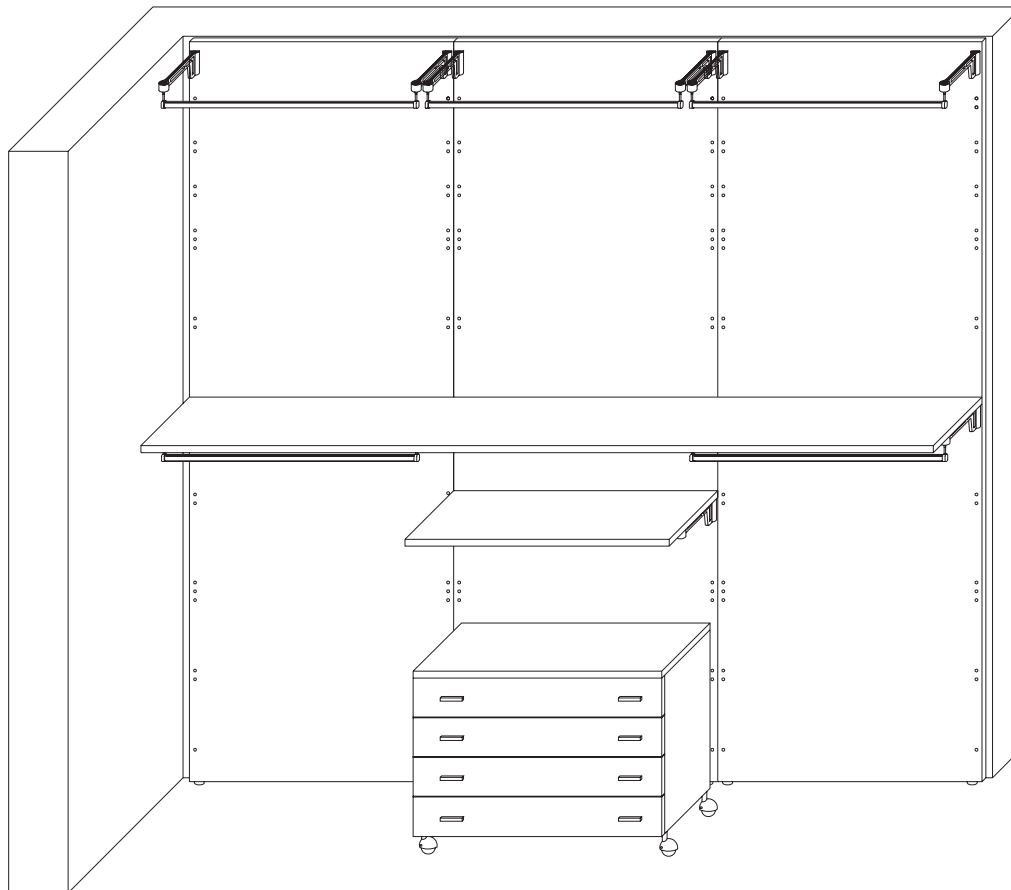

### FINITURE

- Nobilitato bianco
- Nobilitato grigio tessuto
- Nobilitato canapa tessuto
- Nobilitato larice bianco
- Nobilitato larice termo
- Nobilitato olmo urbano

A richiesta, la struttura e le attrezzature interne possono essere fornite in finitura laccato opaco scala RAL, NCS, al campione.

Contattare il Ns. Ufficio Tecnico per specifiche tecniche e preventivi.

**Tutte le attrezzature e i componenti in metallo sono verniciati color grigio alluminio.**



**PANNELLI sp. cm. 1,8**

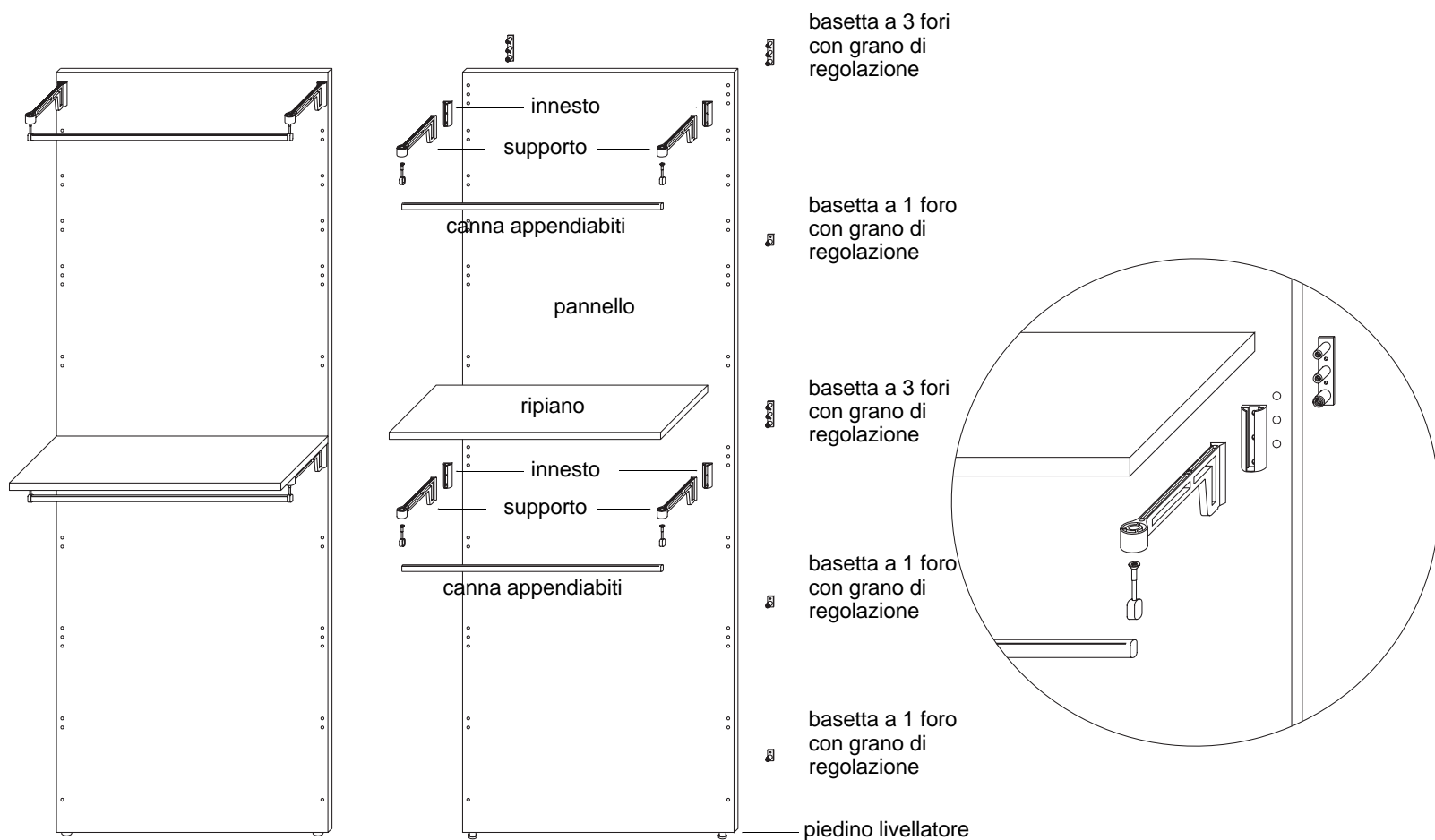

La basetta a 3 fori, oltre al fissaggio delle attrezzature, tramite il terzo foro, consente la regolazione ed il fissaggio del pannello al muro.

La basetta a 2 fori consente solo il fissaggio delle attrezzature sul pannello.

La basetta a 1 foro consente solo la regolazione ed il fissaggio del pannello al muro.

Il grano di regolazione ha un'escursione di cm. 1.

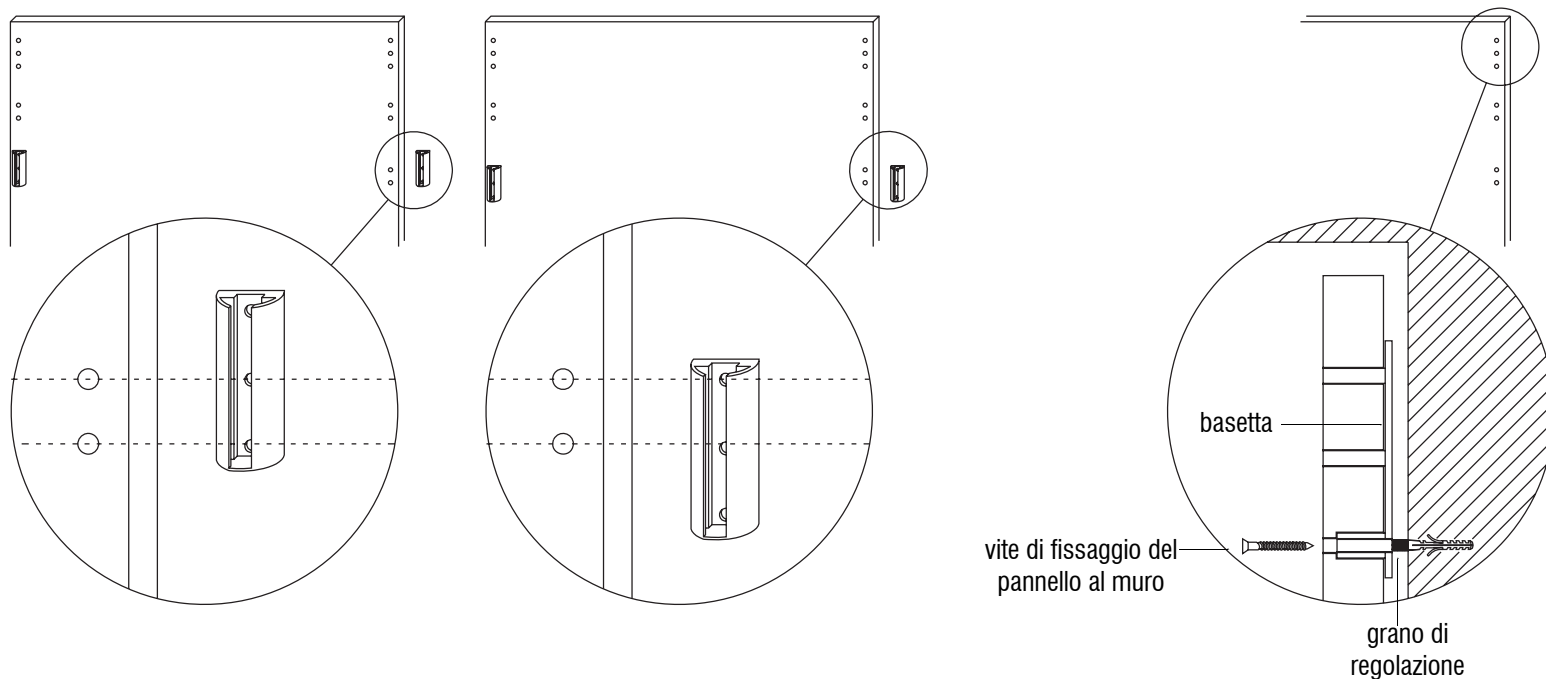

L'innesto a 3 fori consente una doppia posizione delle attrezzature in altezza (+/- 3,2 cm.)

## COMPOSIZIONI LINEARI

Per garantire il montaggio e la regolazione dei pannelli, occorre considerare una tolleranza minima di cm. 1 in altezza e cm. 4 in larghezza (cm. 2 per lato).

### ISTRUZIONI PER CALCOLARE CORRETTAMENTE LE MISURE IN LARGHEZZA

ESEMPIO DI PARETE L. cm. 262

Se non espressamente indicato nell'ordine, i pannelli vengono forniti considerando la larghezza massima, riducendo un solo modulo.

Le attrezzature sono realizzate in base alla larghezza dei pannelli

$$\text{cm. } 2 + 98 + 62 + 98 + 2 = \text{cm. } 262$$

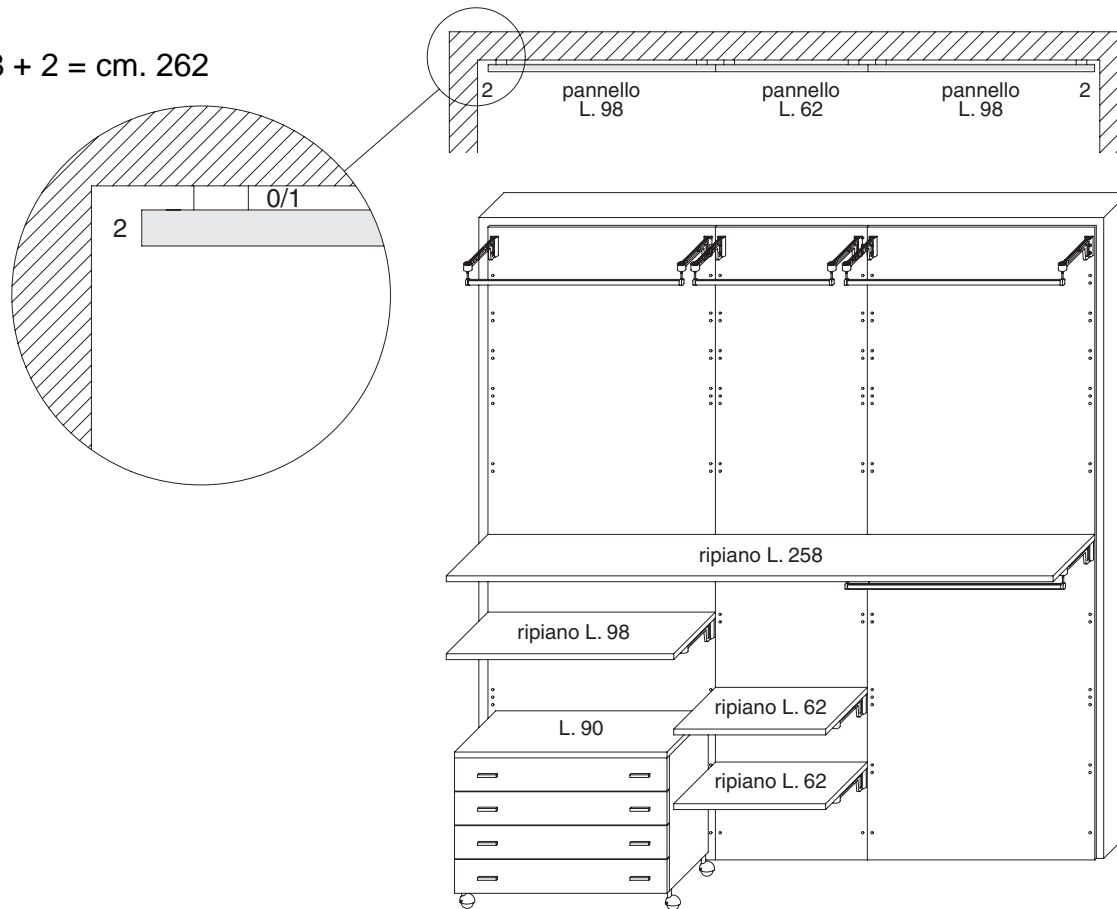

A richiesta, i pannelli possono essere forniti nella stessa larghezza. Le attrezzature sono realizzate in base alla larghezza dei pannelli.

$$\text{cm. } 2 + 86 + 86 + 86 + 2 = \text{cm. } 262$$

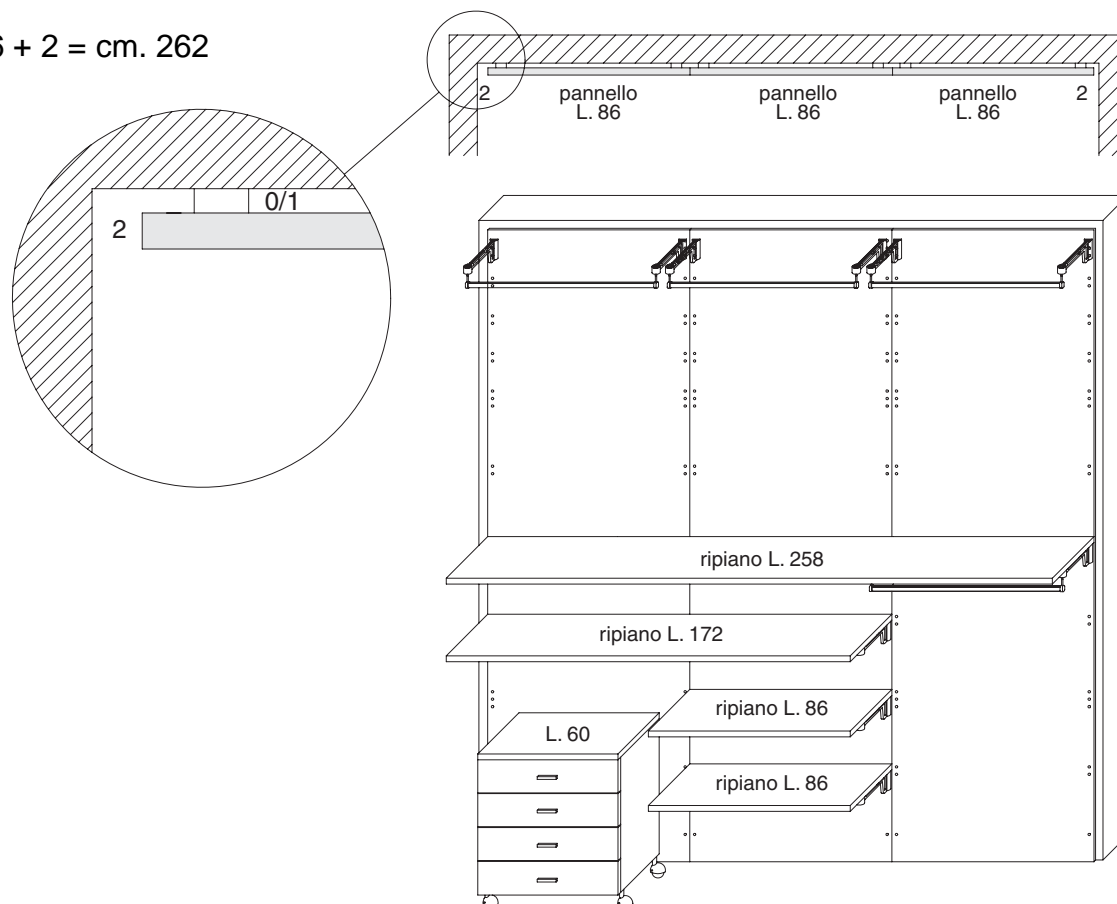

## COMPOSIZIONI ANGOLARI

I pannelli sono raccordati tramite il profilo angolare in alluminio che permette una regolazione in larghezza +/- 1 cm. per lato.

### ISTRUZIONI PER CALCOLARE CORRETTAMENTE LE MISURE IN LARGHEZZA

ESEMPIO DI PARETE L. cm. 161 x 286

PARETE A: cm.  $3 + 56 + 98 + 4 =$  cm. 161

PARETE B: cm.  $4 + 98 + 83 + 98 + 3 =$  cm. 286

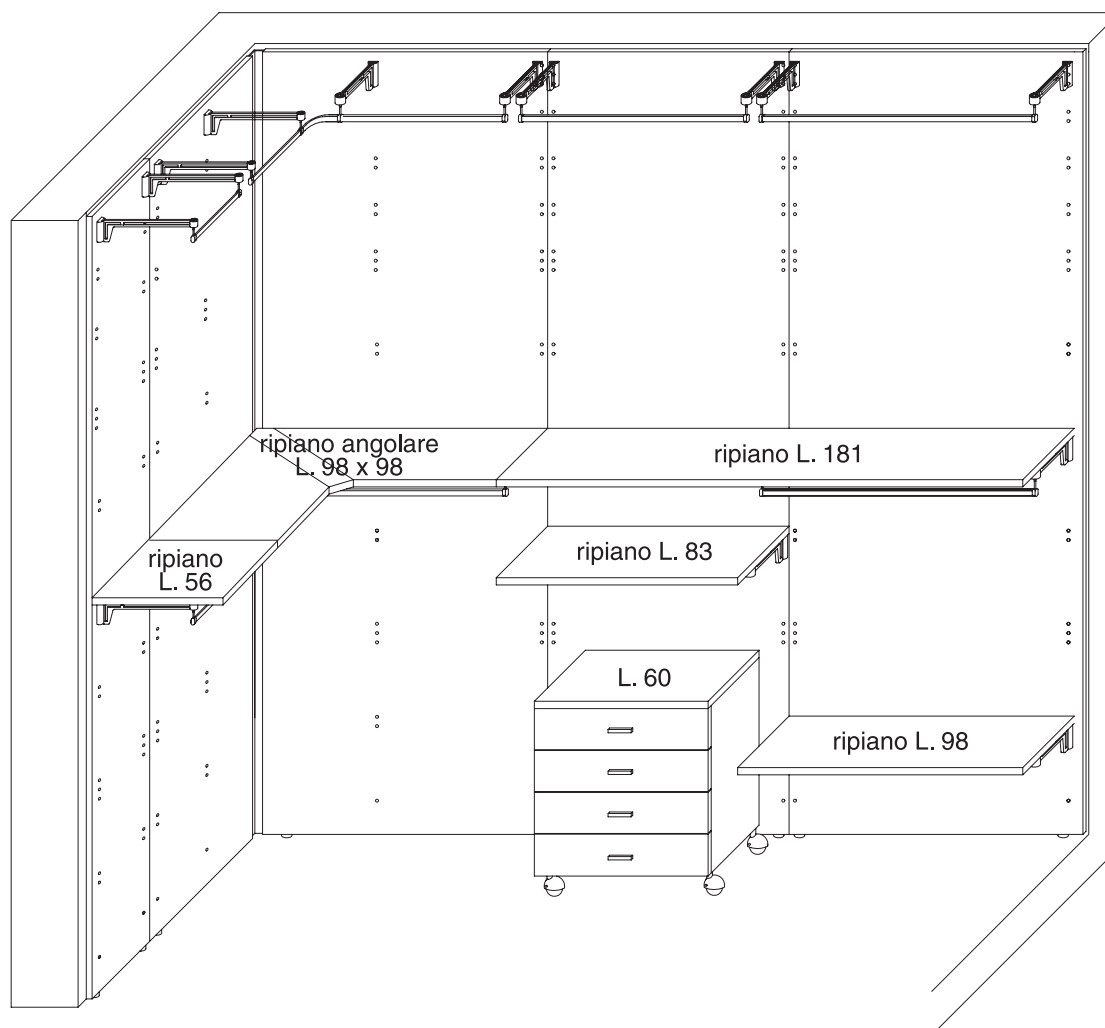
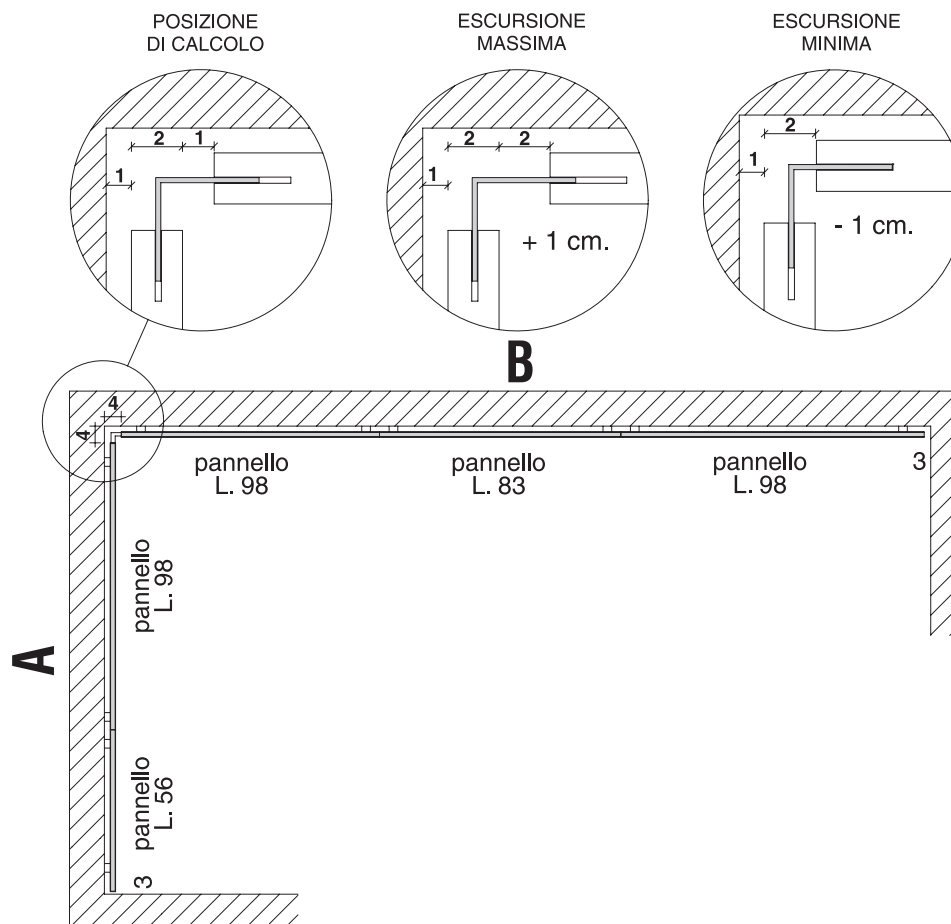

# BOISERIE

I pannelli e i ripiani sono sempre realizzati su misura.

## PANNELLI sp. cm. 1,8 L. max. cm. 98

Non è possibile richiedere forature personalizzate e lavorazioni di pantografatura.

### ALTEZZA

fino a  
H. 237

da H. 238  
a 269

da H. 270  
a 301

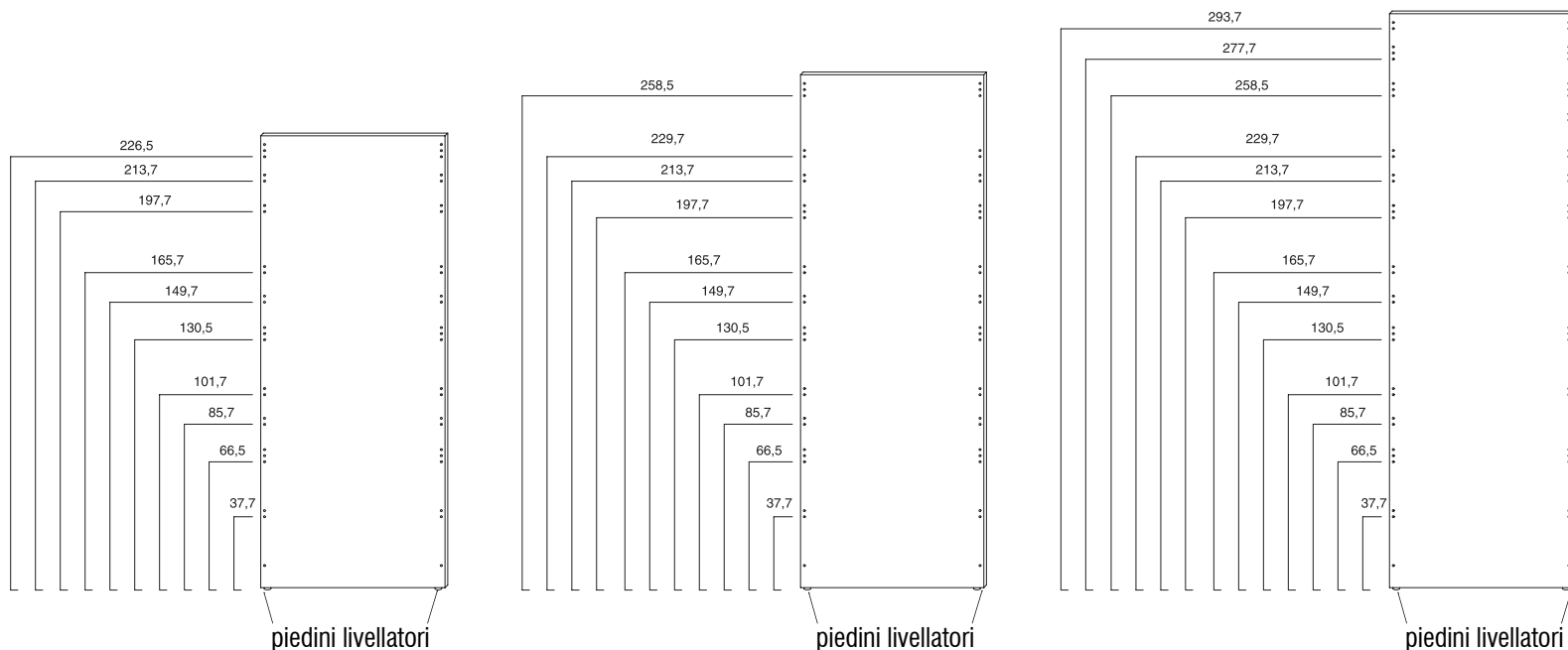

### RIPIANI sp. cm. 2,5

I ripiani sono disponibili fino ad una larghezza massima di cm. 294, equivalente a 3 moduli L. 98.

### LARGHEZZA

fino a L. 294



### PROFONDITÀ

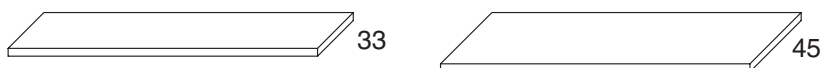

Le attrezzature su ruote: cassettiere, serrandina, ripiano e contenitori necessitano di cm. 3 di spazio laterale per la loro movimentazione.

Pertanto la larghezza del pannello corrispondente deve essere superiore di cm. 3.

# BOISERIE

## PANNELLI sp. cm. 1,8

### ALTEZZA fino a cm. 237

fino a L. 53

da L. 53,1 a 68

da L. 68,1 a 98

profilo angolare  
in alluminio 3x3

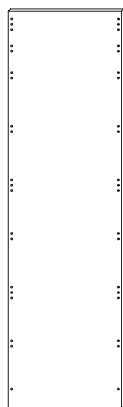
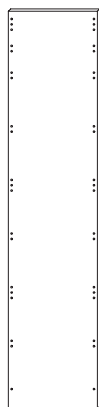

<b>B01</b>	<b>210</b>	<b>B02</b>	<b>246</b>	<b>B03</b>	<b>318</b>	<b>B04</b>	<b>114</b>
------------	------------	------------	------------	------------	------------	------------	------------

### ALTEZZA da cm. 238 a 269

fino a L. 53

da L. 53,1 a 68

da L. 68,1 a 98

profilo angolare  
in alluminio 3x3

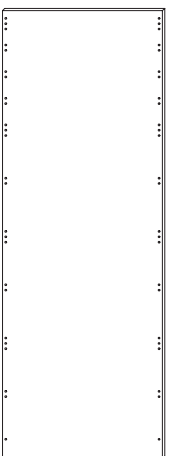
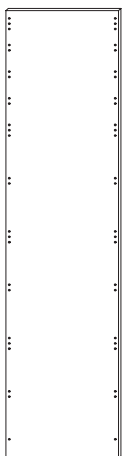
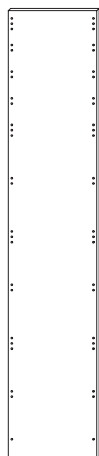

<b>B05</b>	<b>240</b>	<b>B06</b>	<b>285</b>	<b>B07</b>	<b>368</b>	<b>B08</b>	<b>114</b>
------------	------------	------------	------------	------------	------------	------------	------------

### ALTEZZA da cm. 270 a 301

fino a L. 53

da L. 53,1 a 68

da L. 68,1 a 98

profilo angolare  
in alluminio 3x3

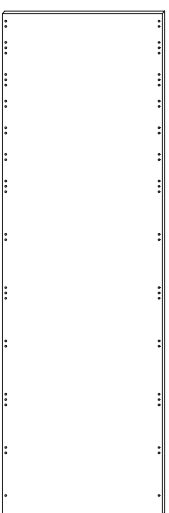
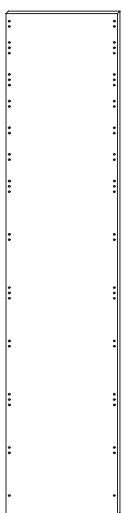
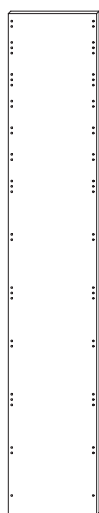

<b>B09</b>	<b>272</b>	<b>B010</b>	<b>318</b>	<b>B011</b>	<b>415</b>	<b>B012</b>	<b>114</b>
------------	------------	-------------	------------	-------------	------------	-------------	------------

# BOISERIE

## PANNELLI DI TAMPONAMENTO sp. cm. 1,8

Non predisposti per il fissaggio delle attrezzature.

### ALTEZZA fino a cm. 237

fino a L. 53

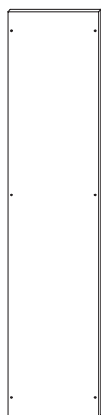

da L. 53,1 a 68

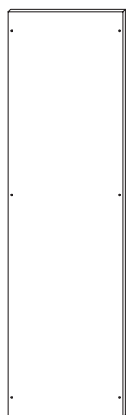

da L. 68,1 a 98

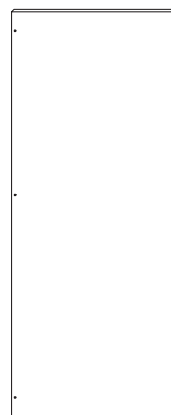

<b>B013</b>	169	<b>B014</b>	208	<b>B015</b>	285
-------------	-----	-------------	-----	-------------	-----

### ALTEZZA da cm. 238 a 269

fino a L. 53



da L. 53,1 a 68

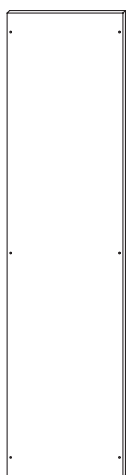

da L. 68,1 a 98

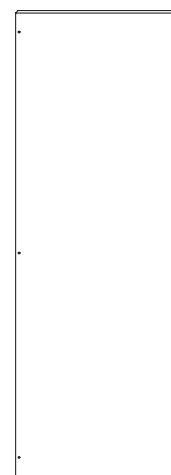

<b>B016</b>	187	<b>B017</b>	231	<b>B018</b>	317
-------------	-----	-------------	-----	-------------	-----

### ALTEZZA da cm. 270 a 301

fino a L. 53



da L. 53,1 a 68

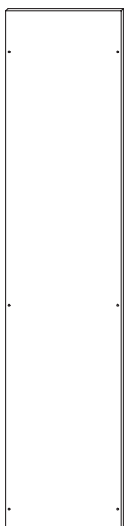

da L. 68,1 a 98

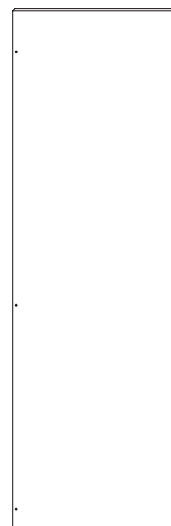

<b>B019</b>	204	<b>B020</b>	254	<b>B021</b>	350
-------------	-----	-------------	-----	-------------	-----

# BOISERIE

## CANNE APPENDIABILI con supporti

fino a L. 53

da L. 53,1 a 68

da L. 68,1 a 98

da L. 70 x 70  
(4 supporti)

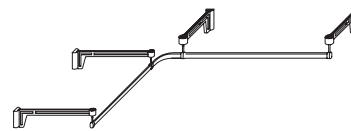

<b>B022</b>	97	<b>B023</b>	98	<b>B024</b>	100	<b>B025</b>	212
-------------	----	-------------	----	-------------	-----	-------------	-----

## CANNE APPENDIABILI senza supporti liberamente posizionabili sotto i ripiani

fino a L. 53

da L. 53,1 a 68

da L. 68,1 a 98

appendiabiti estraibile  
da fissare sotto al ripiano  
P. 33

appendiabiti estraibile  
da fissare sotto al ripiano  
P. 45

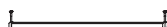

<b>B026</b>	19	<b>B027</b>	20	<b>B028</b>	21	<b>B029</b>	26	<b>B030</b>	26
-------------	----	-------------	----	-------------	----	-------------	----	-------------	----

## APPENDIABILI SALISCENDI - Portata max. kg. 10

fino a L. 53

da L. 53,1 a 68

da L. 68,1 a 98

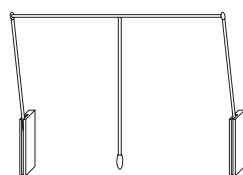
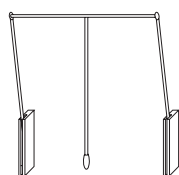
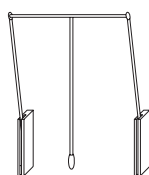

<b>B031</b>	287	<b>B032</b>	287	<b>B033</b>	287
-------------	-----	-------------	-----	-------------	-----

## RIPIANI sp. 2,5 prof. 33 con supporti

fino a L. 53  
2 supporti

da L. 53,1 a 68  
2 supporti

da L. 68,1 a 98  
2 supporti

da L. 98,1 a 106  
4 supporti (2 pannelli)

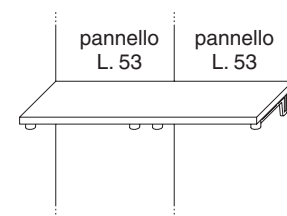
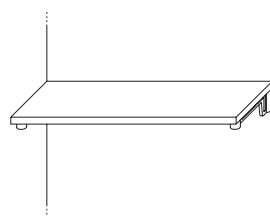
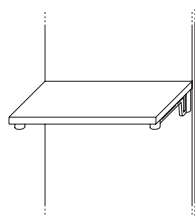
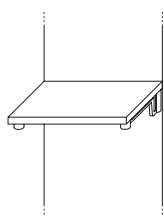

<b>B034</b>	152	<b>B035</b>	164	<b>B036</b>	171	<b>B037</b>	259
-------------	-----	-------------	-----	-------------	-----	-------------	-----

# BOISERIE

## RIPIANI sp. 2,5 prof. 33 con supporti

da L. 106,1 a 121  
4 supporti (2 pannelli)

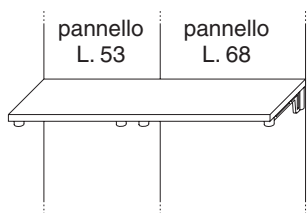

**B038**    **272**

da L. 121,1 a 136  
4 supporti (2 pannelli)

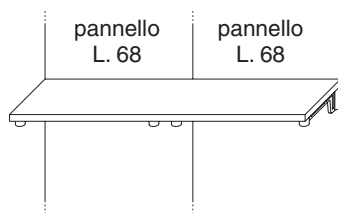

**B039**    **286**

da L. 136,1 a 151  
4 supporti (2 pannelli)

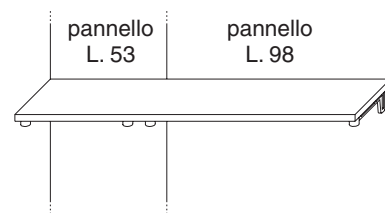

**B040**    **300**

da L. 151,1 a 166  
4 supporti (2 pannelli)

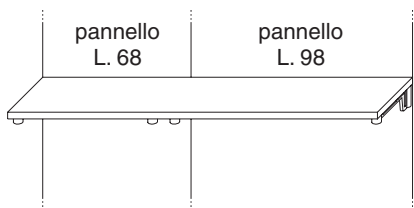

**B041**    **313**

da L. 166,1 a 196  
4 supporti (2 pannelli)

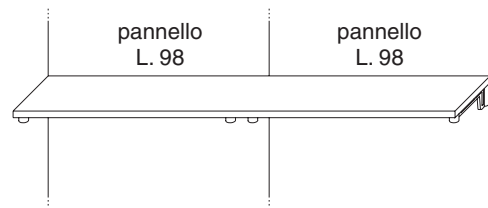

**B042**    **327**

da L. 196,1 a 204  
6 supporti (3 pannelli)

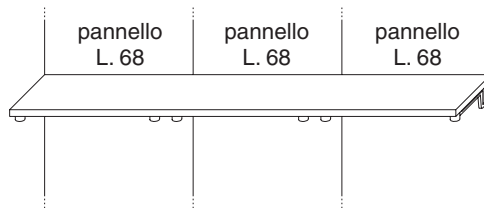

**B043**    **411**

da L. 204,1 a 219  
6 supporti (3 pannelli)

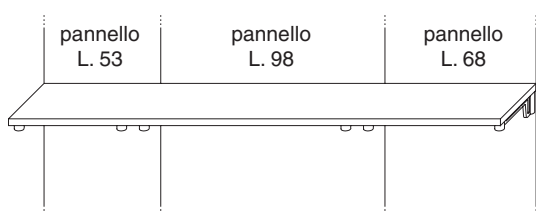

**B044**    **423**

da L. 219,1 a 234  
6 supporti (3 pannelli)

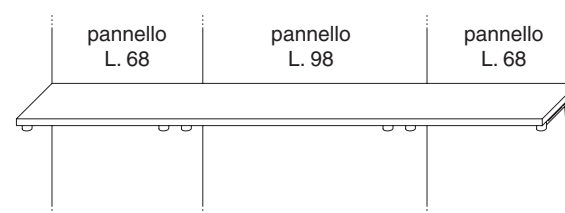

**B045**    **438**

da L. 234,1 a 249  
6 supporti (3 pannelli)

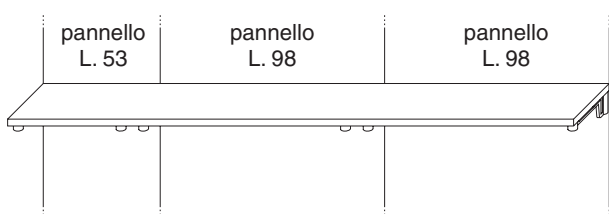

**B046**    **451**

da L. 249,1 a 264  
6 supporti (3 pannelli)

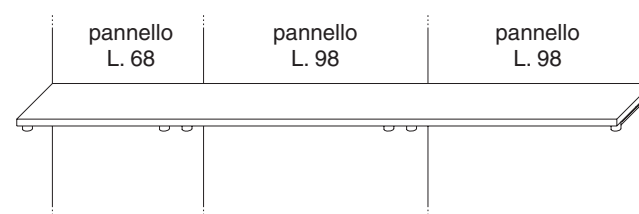

**B047**    **465**



# BOISERIE

## RIPIANI sp. 2,5 prof. 33 con supporti

da L. 264,1 a 294  
6 supporti (3 pannelli)

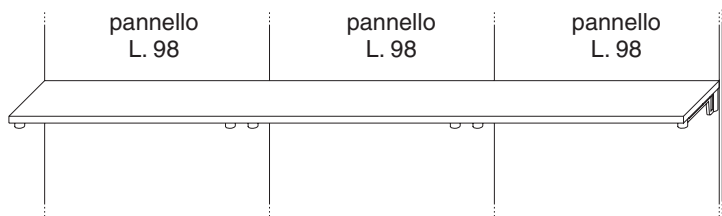

L. 98 x 98  
4 supporti (2 pannelli)

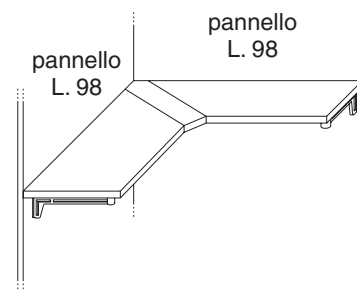

<b>B048</b>	<b>479</b>	<b>B049</b>	<b>466</b>
-------------	------------	-------------	------------

## RIPIANI sp. 2,5 prof. 45 con supporti

fino a L. 53  
2 supporti

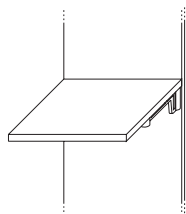

da L. 53,1 a 68  
2 supporti

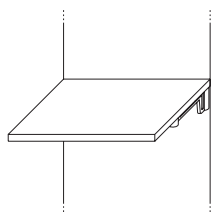

da L. 68,1 a 98  
2 supporti

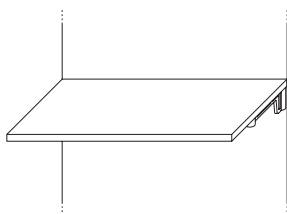

da L. 98,1 a 106  
4 supporti (2 pannelli)

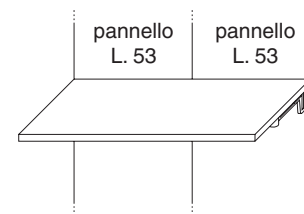

<b>B050</b>	<b>154</b>	<b>B051</b>	<b>166</b>	<b>B052</b>	<b>174</b>	<b>B053</b>	<b>262</b>
-------------	------------	-------------	------------	-------------	------------	-------------	------------

da L. 106,1 a 121  
4 supporti (2 pannelli)

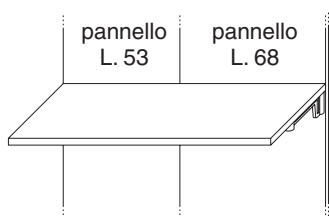

da L. 121,1 a 136  
4 supporti (2 pannelli)

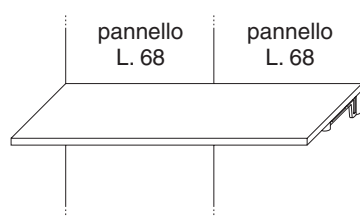

da L. 136,1 a 151  
4 supporti (2 pannelli)

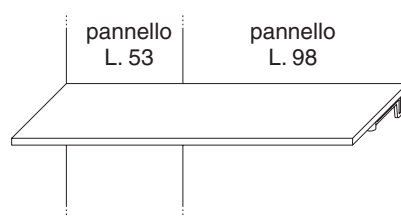

<b>B054</b>	<b>277</b>	<b>B055</b>	<b>291</b>	<b>B056</b>	<b>308</b>
-------------	------------	-------------	------------	-------------	------------

da L. 151,1 a 166  
4 supporti (2 pannelli)

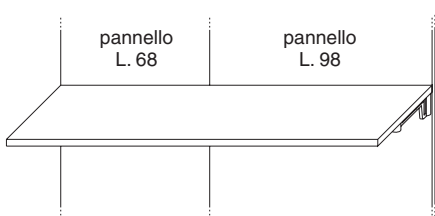

da L. 166,1 a 196  
4 supporti (2 pannelli)

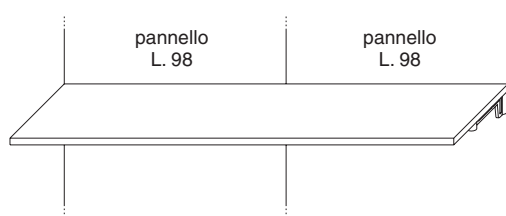

da L. 196,1 a 204  
6 supporti (3 pannelli)

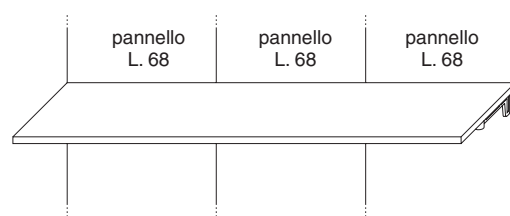

<b>B057</b>	<b>323</b>	<b>B058</b>	<b>337</b>	<b>B059</b>	<b>422</b>
-------------	------------	-------------	------------	-------------	------------

# BOISERIE

## RIPIANI sp. 2,5 prof. 45 con supporti

da L. 204,1 a 219  
6 supporti (3 pannelli)

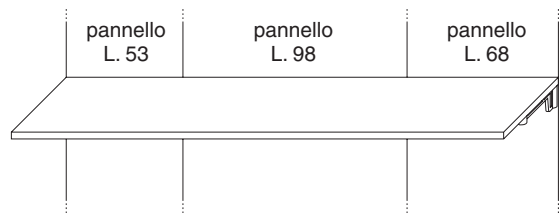

da L. 219,1 a 234  
6 supporti (3 pannelli)

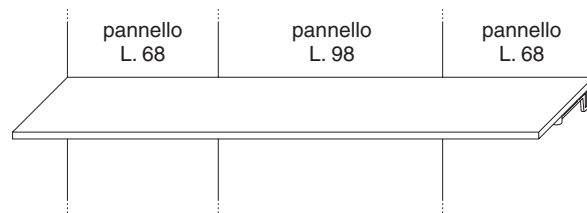

<b>B060</b>	<b>438</b>	<b>B061</b>	<b>452</b>
-------------	------------	-------------	------------

## RIPIANI sp. 2,5 prof. 45 con supporti

da L. 234,1 a 249  
6 supporti (3 pannelli)

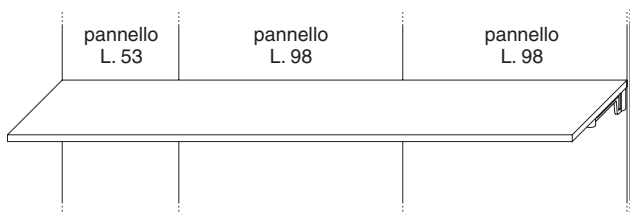

da L. 249,1 a 264  
6 supporti (3 pannelli)

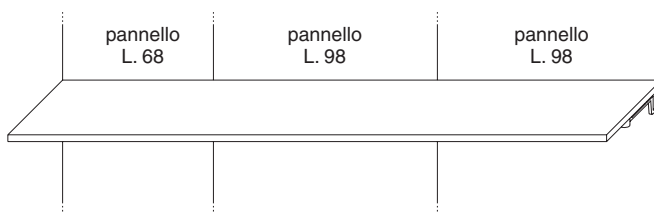

<b>B062</b>	<b>467</b>	<b>B063</b>	<b>484</b>
-------------	------------	-------------	------------

da L. 264,1 a 294  
6 supporti (3 pannelli)

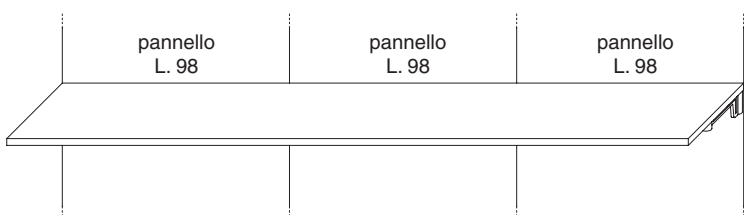

L. 98 x 98  
4 supporti (2 pannelli)

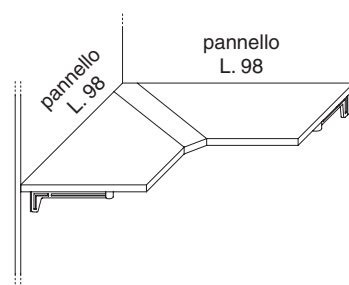

ripiano portapantaloni ad estrazione totale con BLUMOTION  
L. 98  
2 supporti

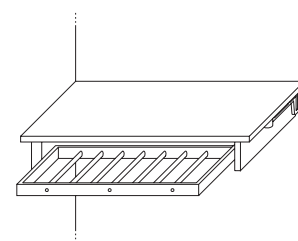

<b>B064</b>	<b>496</b>	<b>B065</b>	<b>483</b>	<b>B066</b>	<b>383</b>
-------------	------------	-------------	------------	-------------	------------

## RIPIANI sp. 2,5 prof. 45 con supporti e canne appendiabiti

fino a L. 53  
2 supporti

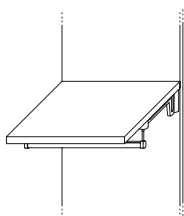

da L. 53,1 a 68  
2 supporti

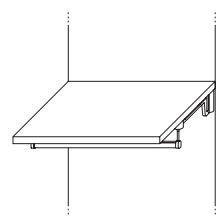

da L. 68,1 a 98  
2 supporti

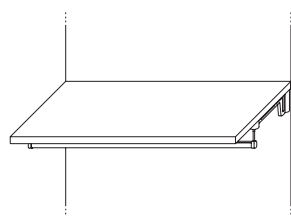

da L. 98,1 a 106  
4 supporti (2 pannelli)

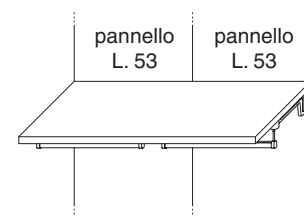

<b>B067</b>	<b>171</b>	<b>B068</b>	<b>182</b>	<b>B069</b>	<b>195</b>	<b>B070</b>	<b>295</b>
-------------	------------	-------------	------------	-------------	------------	-------------	------------

# BOISERIE

## RIPIANI sp. 2,5 prof. 45 con supporti e canne appendiabiti

da L. 106,1 a 121  
4 supporti (2 pannelli)

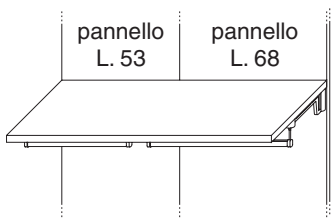

**B071    313**

da L. 121,1 a 136  
4 supporti (2 pannelli)

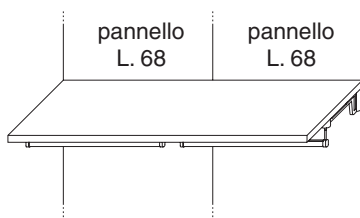

**B072    329**

da L. 136,1 a 151  
4 supporti (2 pannelli)

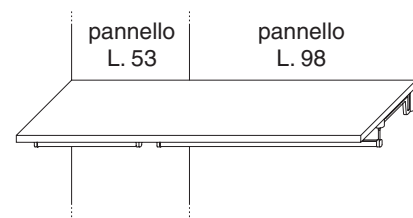

**B073    344**

da L. 151,1 a 166  
4 supporti (2 pannelli)

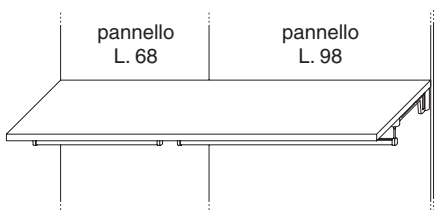

**B074    360**

da L. 166,1 a 196  
4 supporti (2 pannelli)

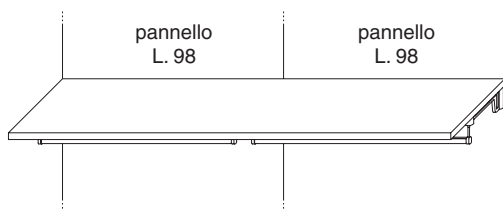

**B075    376**

da L. 196,1 a 204  
6 supporti (3 pannelli)

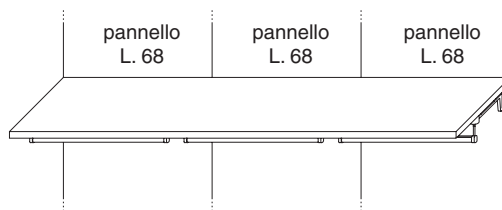

**B076    477**

da L. 204,1 a 219  
6 supporti (3 pannelli)

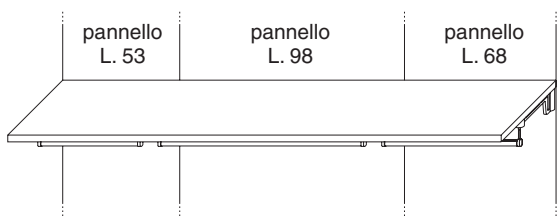

**B077    492**

da L. 219,1 a 234  
6 supporti (3 pannelli)

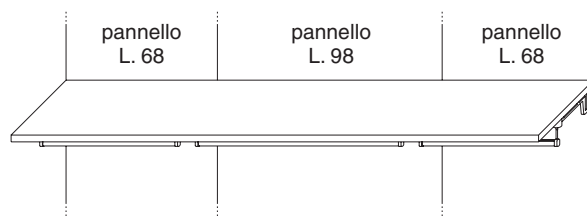

**B078    510**

da L. 234,1 a 249  
6 supporti (3 pannelli)

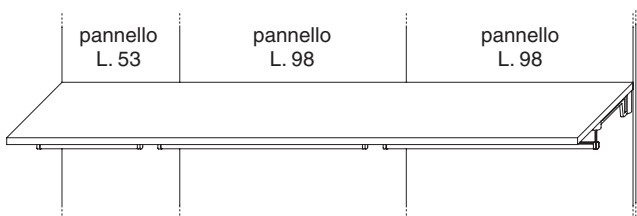

**B079    522**

da L. 249,1 a 264  
6 supporti (3 pannelli)

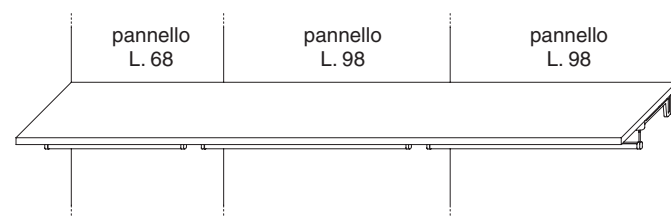

**B080    539**

# BOISERIE

## RIPIANI sp. 2,5 prof. 45 con supporti e canne appendiabiti

da L. 264,1 a 294  
6 supporti (3 pannelli)

L. 98 x 98  
4 supporti (2 pannelli)

Supporto in pressofusione di zama color grigio alluminio necessario per il fissaggio delle attrezzature

LE ATTREZZATURE SONO GIÀ COMPRENSIVE DEI SUPPORTI IN NUMERO NECESSARIO PER IL LORO FISSAGGIO AL PANNELLO

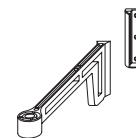
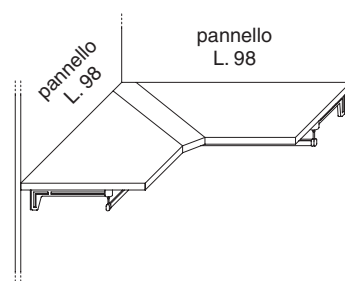
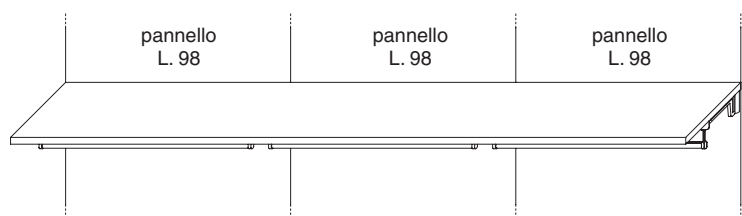

<b>B081</b>	<b>558</b>	<b>B082</b>	<b>525</b>	<b>B083</b>	<b>42</b>
-------------	------------	-------------	------------	-------------	-----------

## CASSETTIERE SOSPESA

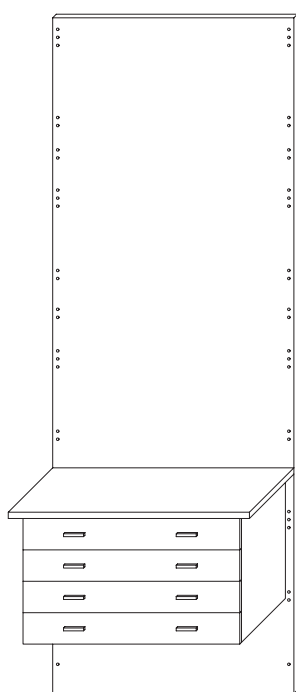

## CASSETTIERE SOSPESA ad estrazione totale con BLUMOTION H. 34,1 P. 45

L. 53

L. 68

L. 98

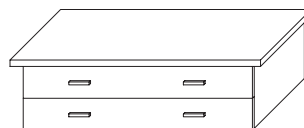

L. 45

L. 60

L. 90

<b>B084</b>	<b>483</b>	<b>B085</b>	<b>517</b>	<b>B086</b>	<b>552</b>
-------------	------------	-------------	------------	-------------	------------

## CASSETTIERE SOSPESA ad estrazione totale con BLUMOTION H. 64,7 P. 45

L. 53

L. 68

L. 98

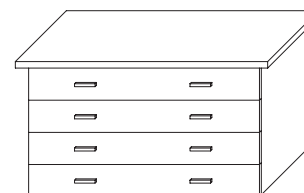

L. 45

L. 60

L. 90

<b>B087</b>	<b>685</b>	<b>B088</b>	<b>736</b>	<b>B089</b>	<b>783</b>
-------------	------------	-------------	------------	-------------	------------

## BOISERIE

### CASSETTIERE SU RUOTE ad estrazione totale con BLUMOTION H. 42,1 P. 45

L. 45

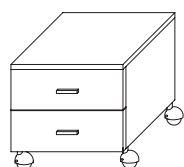

L. 60

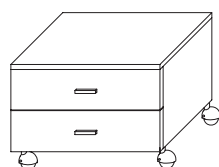

L. 90



<b>B090</b>	<b>437</b>	<b>B091</b>	<b>471</b>	<b>B092</b>	<b>508</b>
-------------	------------	-------------	------------	-------------	------------

### CASSETTIERE SU RUOTE ad estrazione totale con BLUMOTION H. 72,7 P. 45

L. 45

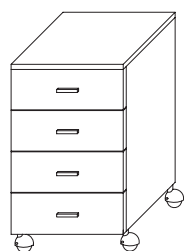

L. 60

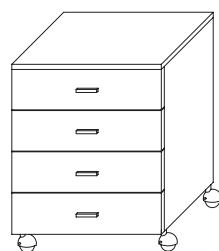

L. 90

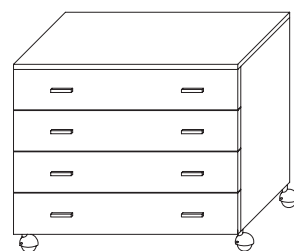

<b>B093</b>	<b>640</b>	<b>B094</b>	<b>691</b>	<b>B095</b>	<b>739</b>
-------------	------------	-------------	------------	-------------	------------

### CASSETTIERE SU RUOTE ad estrazione totale con BLUMOTION H. 103,3 P. 45

L. 45

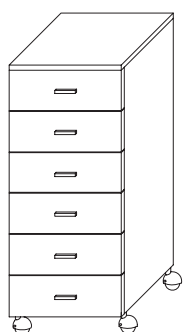

L. 60

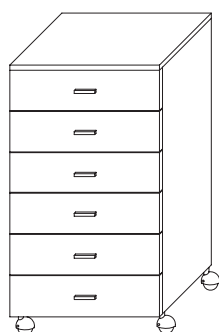

L. 90

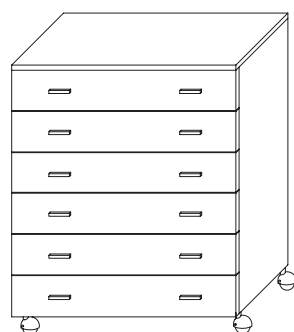

<b>B096</b>	<b>898</b>	<b>B097</b>	<b>963</b>	<b>B098</b>	<b>1.030</b>
-------------	------------	-------------	------------	-------------	--------------

### ELEMENTI SU RUOTE

cesto portabiancheria  
in filo di ferro  
L. 45 H. 57,5 P. 43

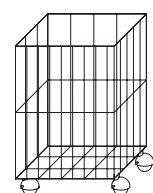

ripiano portascatoie  
L. 90 H. 18,5 P. 45

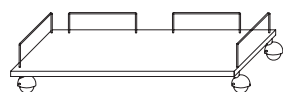

contenitore in lamiera  
L. 90 H. 34,7 P. 45

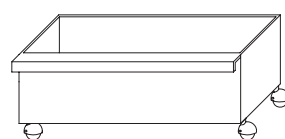

<b>B099</b>	<b>94</b>	<b>B0100</b>	<b>138</b>	<b>B0101</b>	<b>317</b>
-------------	-----------	--------------	------------	--------------	------------

# BOISERIE

## ELEMENTI SU RUOTE

serrandina con 3  
ripiani in vetro  
L. 90 H. 103,3 P. 45

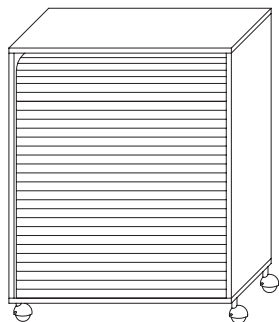

alveare  
L. 90 H. 103,3 P. 45

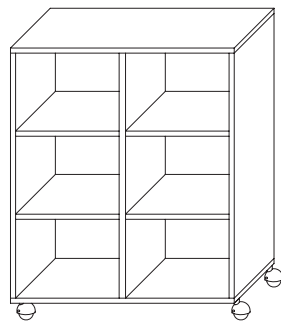

B0102	841	B0103	390
-------	-----	-------	-----

## ATTREZZATURE da fissare sul pannello o a parete con viti

pomolo appendiabiti



svuotatasche  
L 30 H. 10 P.15

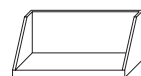

portacravatte  
L 50 H. 9



portacinture  
L 50 H. 9



B0104	17	B0105	51	B0106	81	B0107	140
-------	----	-------	----	-------	----	-------	-----

portagonne  
portapantaloni  
L. 50 - H. 9 - P. 20

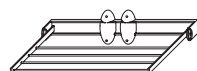

portascarpe estensibile  
in filo di ferro P.20  
L. 67/115



Vaschetta per  
portascarpe  
estensibile  
(facoltativo)

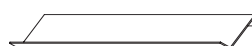

portascarpe  
L. 48 H. 70 P. 22

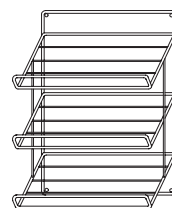

specchio  
L. 36 H. 160



B0108	148	B0109	47	B0110	70	B0111	84	B0112	94
-------	-----	-------	----	-------	----	-------	----	-------	----

## PANCHE sp. 2,5 prof. 45 CON ZOCCOLO IN ALLUMINIO H. 4

fino a L. 100

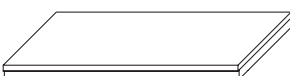

da L. 100,1 a 150

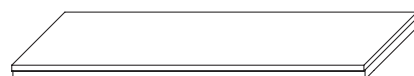

da L. 150,1 a 200

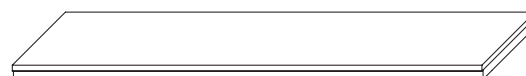

B0113	167	B0114	221	B0115	265
-------	-----	-------	-----	-------	-----

da L. 200,1 a 250

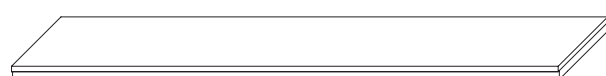

da L. 250,1 a 300

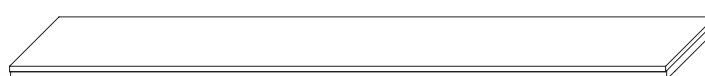

B0116	332	B0117	376
-------	-----	-------	-----

## COMPOSIZIONI

Aggiungere cm. 2 per lato per composizioni lineari e cm. 3 per lato per composizioni angolari, necessari per il montaggio.

I prezzi si intendono riferiti a composizioni con pannelli H. cm. 269

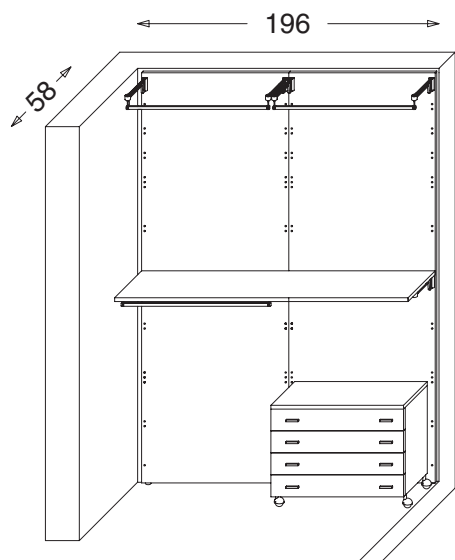

**B0118** 2.022

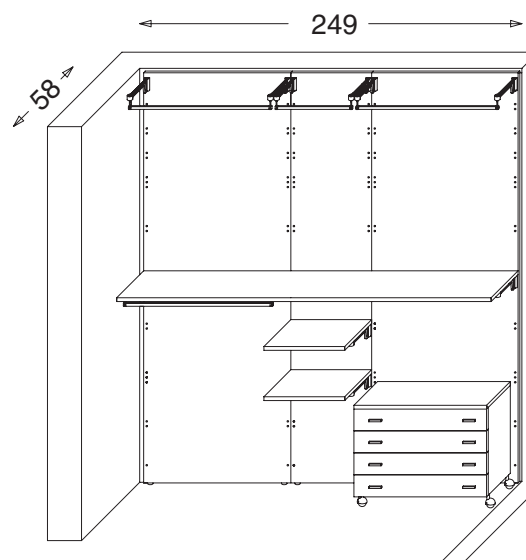

**B0119** 2.790

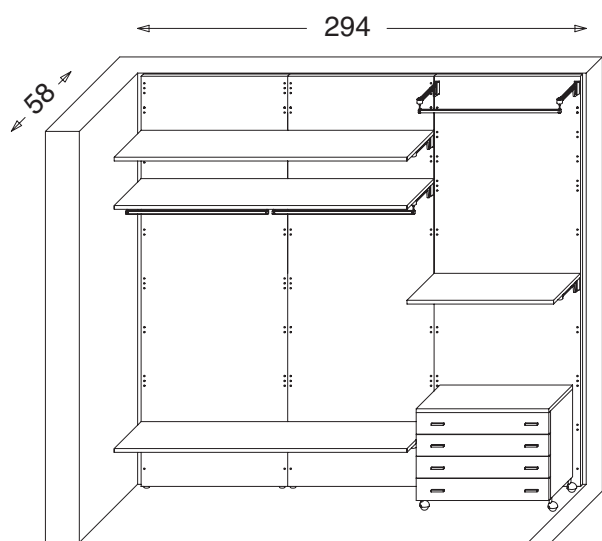

**B0120** 3.154

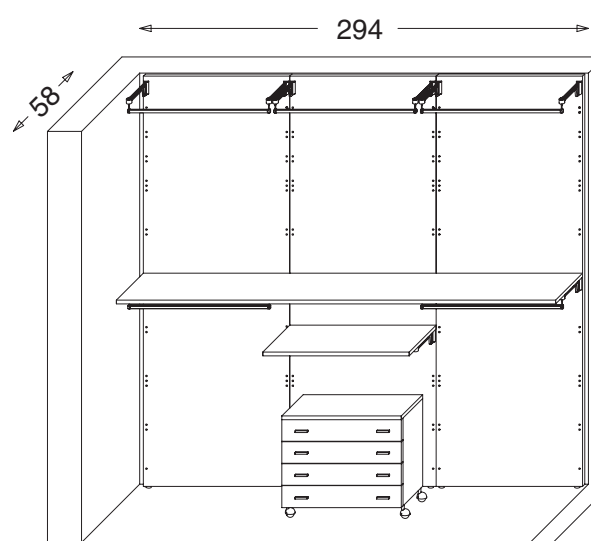

**B0121** 2.837

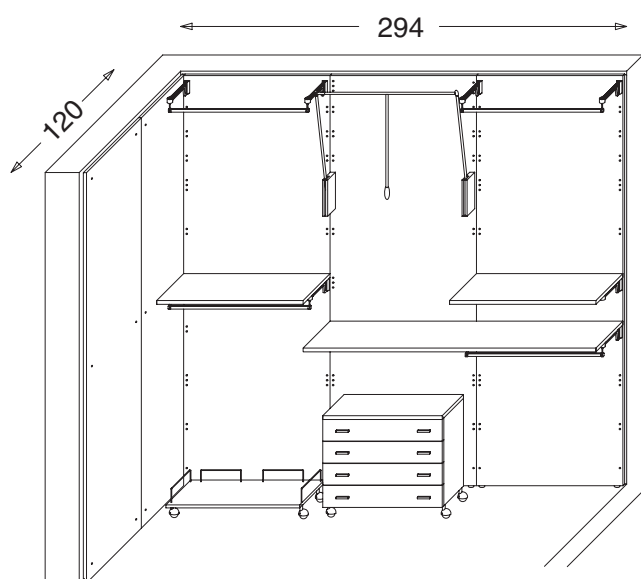

**B0122** 3.174

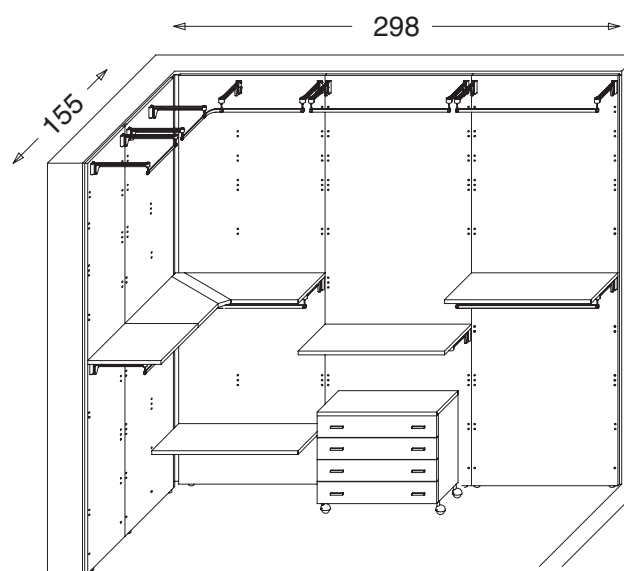

**B0123** 4.285

## I TUBI

La cabina armadio I TUBI è un sistema alternativo al solito armadio.

La cabina armadio è costituita da tubi verticali in metallo di colore grigio alluminio ed una serie di attrezzature appositamente studiate: canne appendiabiti, ripiani, cassettiere ed altre ancora.

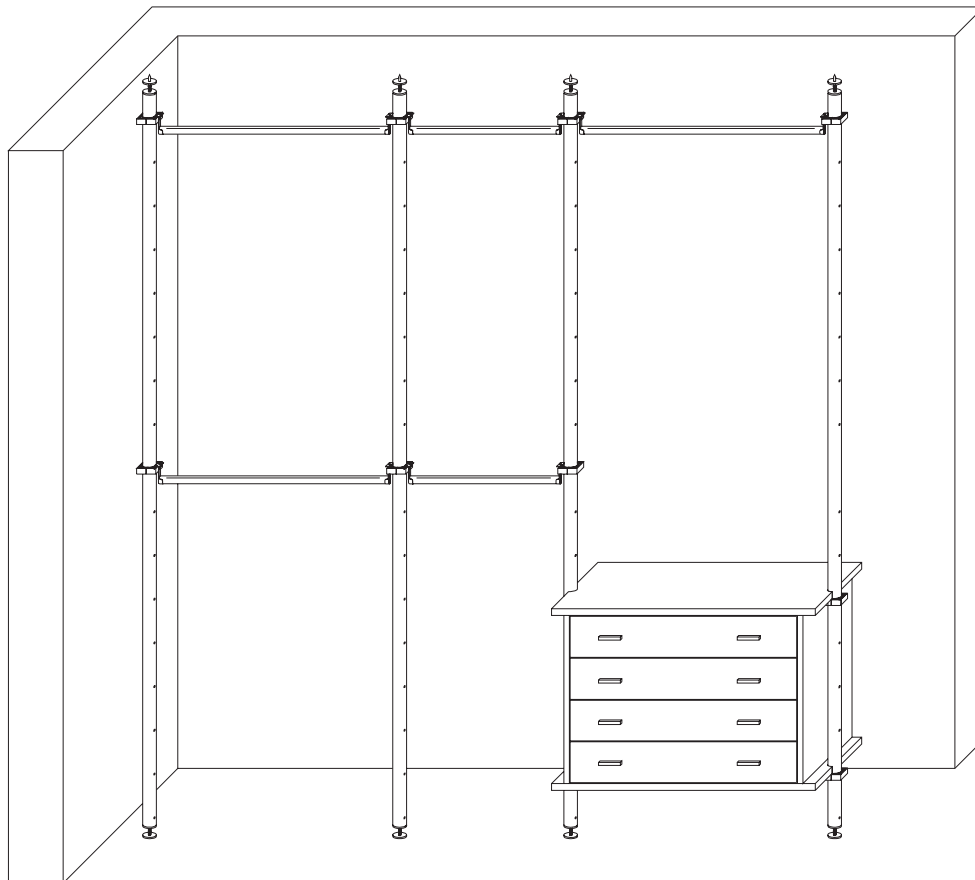

### FINITURE

- Nobilitato bianco
- Nobilitato grigio tessuto
- Nobilitato canapa tessuto
- Nobilitato larice bianco
- Nobilitato larice termo
- Nobilitato olmo urbano

A richiesta, le attrezzature interne possono essere fornite in finitura laccato opaco scala RAL, NCS, al campione. Contattare il Ns. Ufficio Tecnico per specifiche tecniche e preventivi.

**Tutte le attrezzature e i componenti in metallo sono verniciati color grigio alluminio.**



## I TUBI

TUBI Ø cm. 5 H. fino a cm. 400 color grigio alluminio.

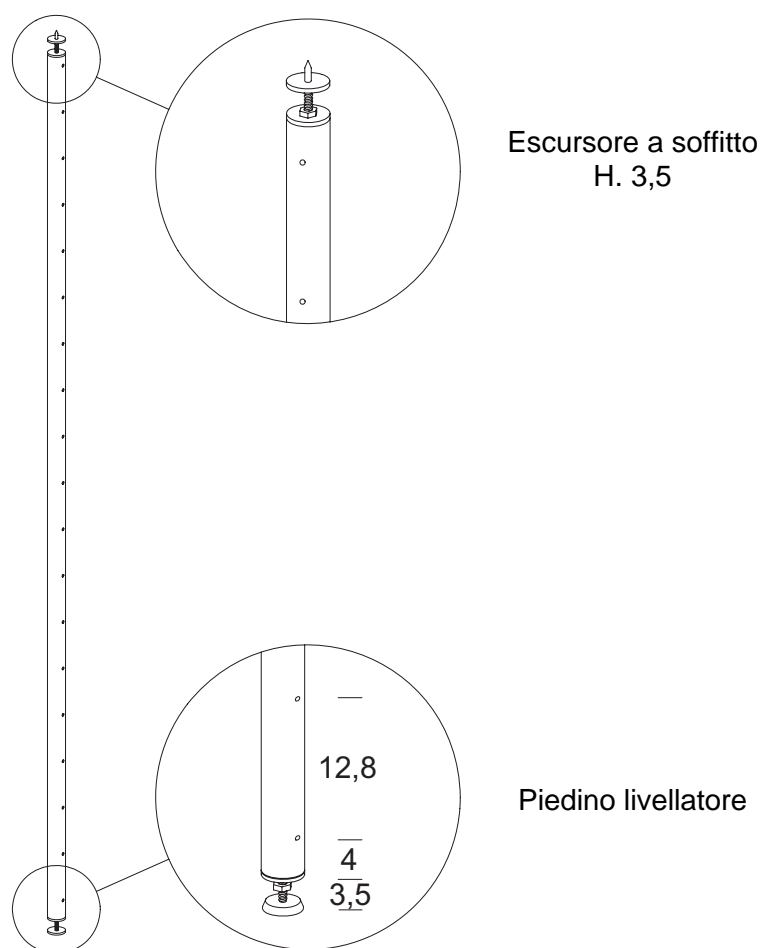

### RIPIANI sp. cm. 2,5

I ripiani sono sempre realizzati su misura.

### LARGHEZZA

**MISURA ESTERNA** fino a L. 180    **MISURA INTERNA** fino a L. 175

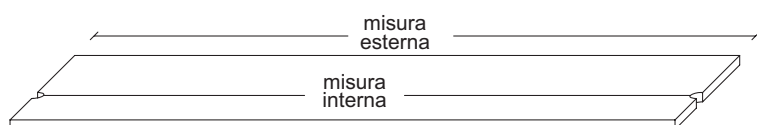

### PROFONDITÀ

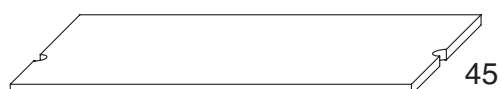

I ripiani sono disponibili anche con taglio a 45° per composizioni ad angolo.



Le attrezzature su ruote: cassettiere, serrandina, ripiano e contenitori necessitano di cm. 3 di spazio laterale per la loro movimentazione.

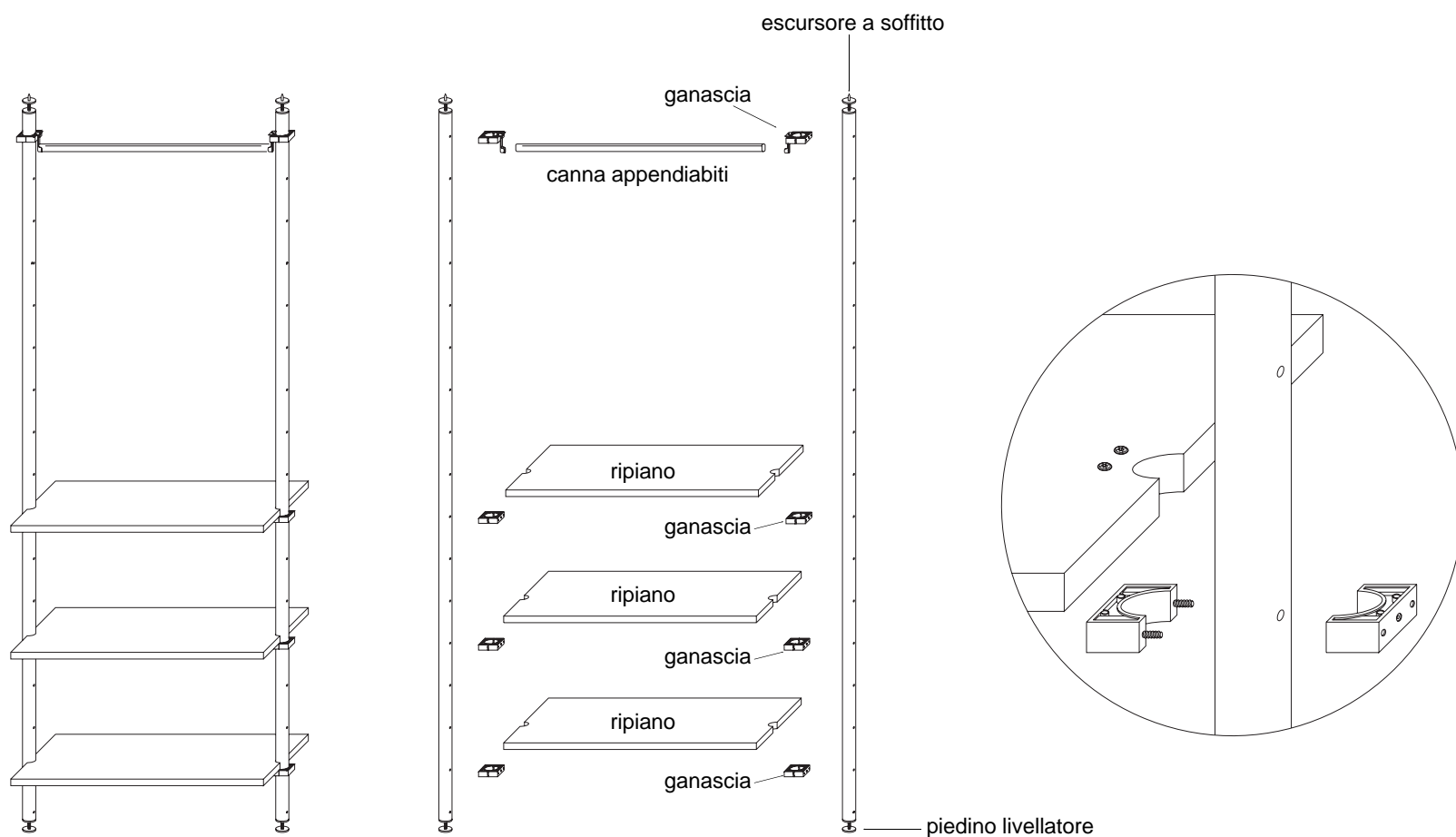

## GANASCE

La ganascia è costituita da due parti unite mediante due viti filettate 5 MA, ha un grano che si inserisce nel foro del tubo garantendo una tenuta al carico perfetta nel tempo, ed è indispensabile per il posizionamento di tutte le attrezzature.

In fase di progettazione della cabina armadio si è preferito l'utilizzo della ganascia invece della filettatura dei fori, per evitare che a seguito di più montaggi si deteriori la foratura compromettendo la tenuta della struttura. Inoltre, essendo la ganascia formata da due parti, permette di togliere, aggiungere o modificare la posizione delle attrezzature facilmente e in qualsiasi momento, senza dover smontare il tubo già fissato da pavimento a soffitto.

In fase di allestimento della cabina armadio si consiglia l'allineamento delle attrezzature, per utilizzare un minor numero di ganasce.

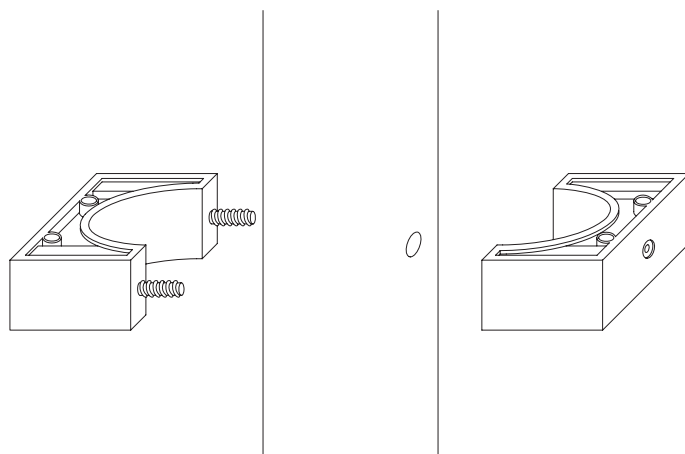

## COMPOSIZIONI LINEARI

Per garantire il montaggio e la regolazione dei tubi, occorre considerare una tolleranza di cm. 5 in larghezza (cm. 2,5 per lato).

### ISTRUZIONI PER CALCOLARE CORRETTAMENTE LE MISURE IN LARGHEZZA

Sommare le misure delle attrezzature, cm. 2,5 per ingombro tubo iniziale, cm. 2,5 per ingombro tubo terminale, cm. 5 per il montaggio (cm. 2,5 per lato).

ESEMPIO DI PARETE L. cm. 280

$\text{cm. } 2,5 + 2,5 + 98 + 74 + 98 + 2,5 + 2,5 = \text{cm. } 280$

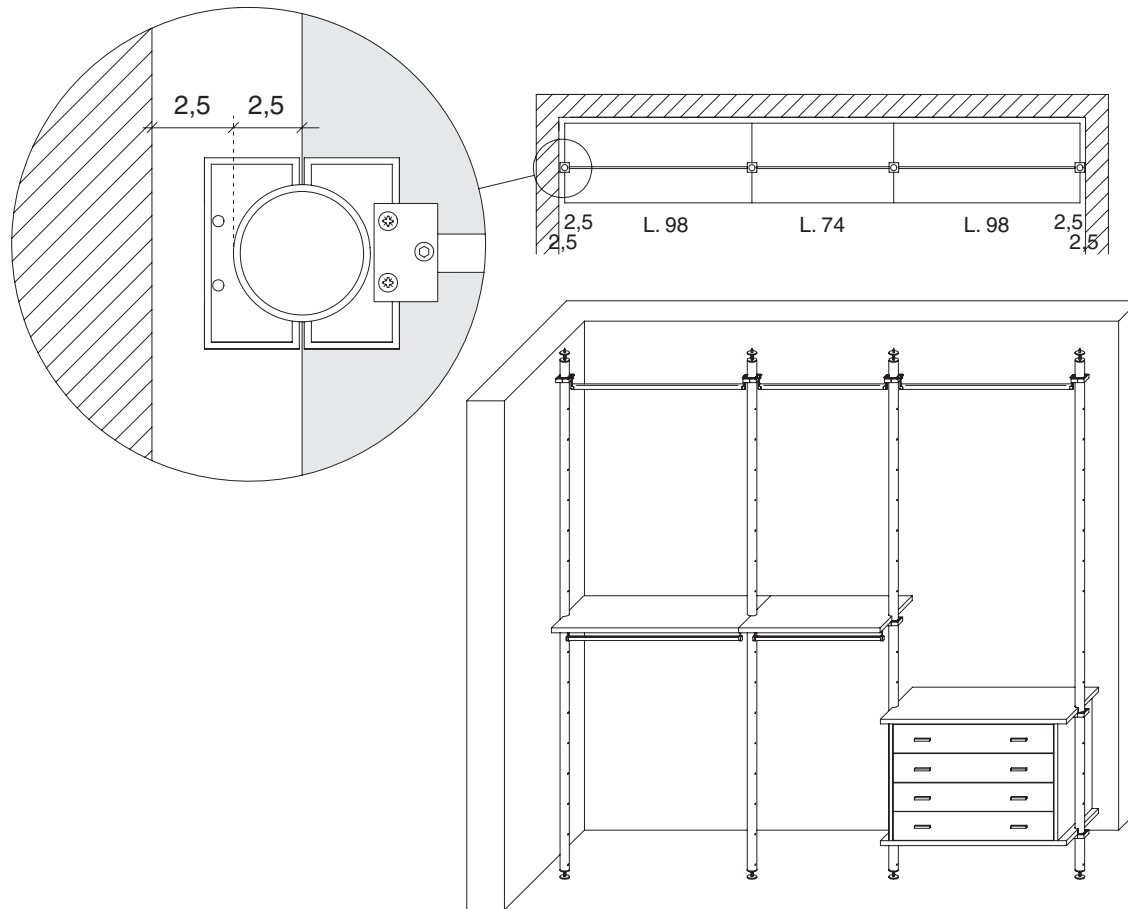

Composizione come precedente con l'uso di una campata grande.

$\text{cm. } 2,5 + 2,5 + 172 + 98 + 2,5 + 2,5 = \text{cm. } 280$

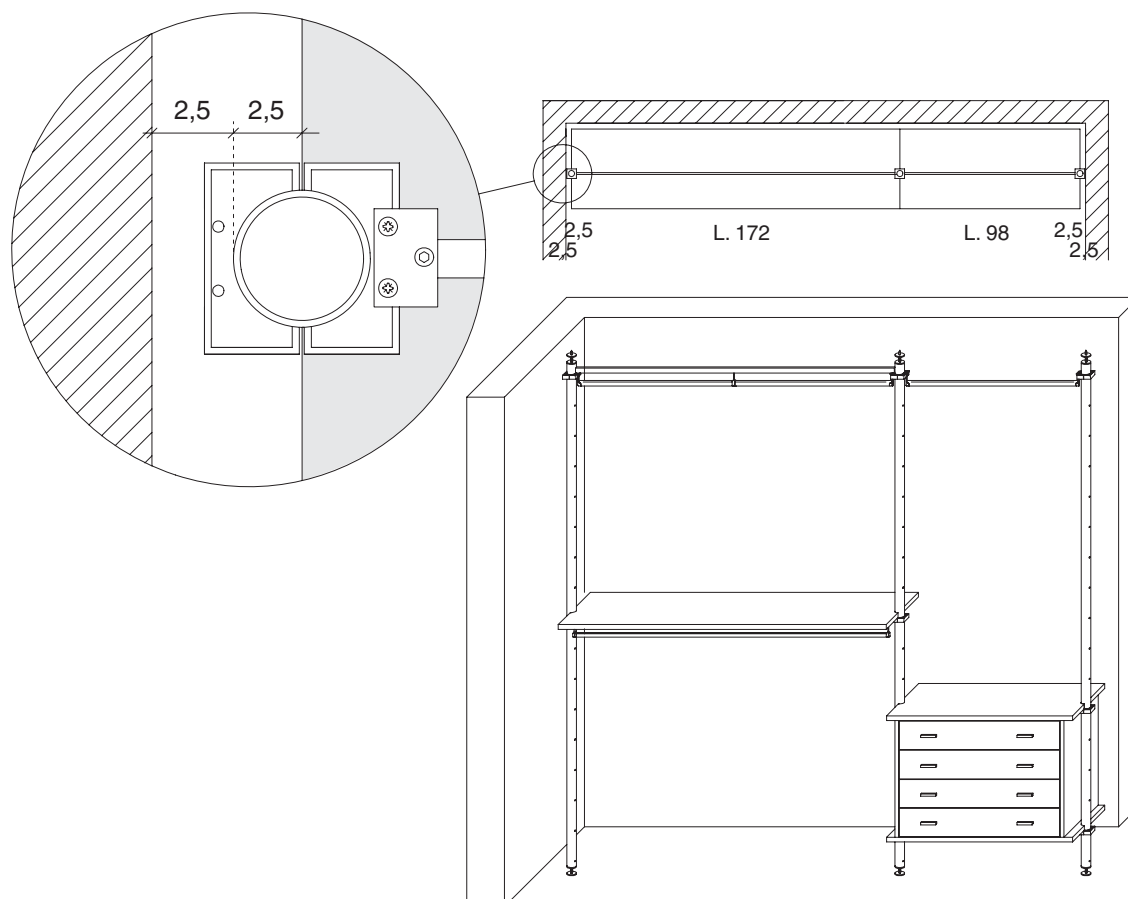

# I TUBI

## COMPOSIZIONI ANGOLARI

ISTRUZIONI PER CALCOLARE CORRETTAMENTE LE MISURE IN LARGHEZZA

ESEMPIO DI PARETE L. cm. 123 x 299

PARETE A: cm.  $2,5 + 2,5 + 90 + 2,5 + 25,5 =$  cm. 123

PARETE B: cm.  $25,5 + 2,5 + 70 + 98 + 98 + 2,5 + 2,5 =$  cm. 299

distanza minima  
necessaria per il  
montaggio del tubo

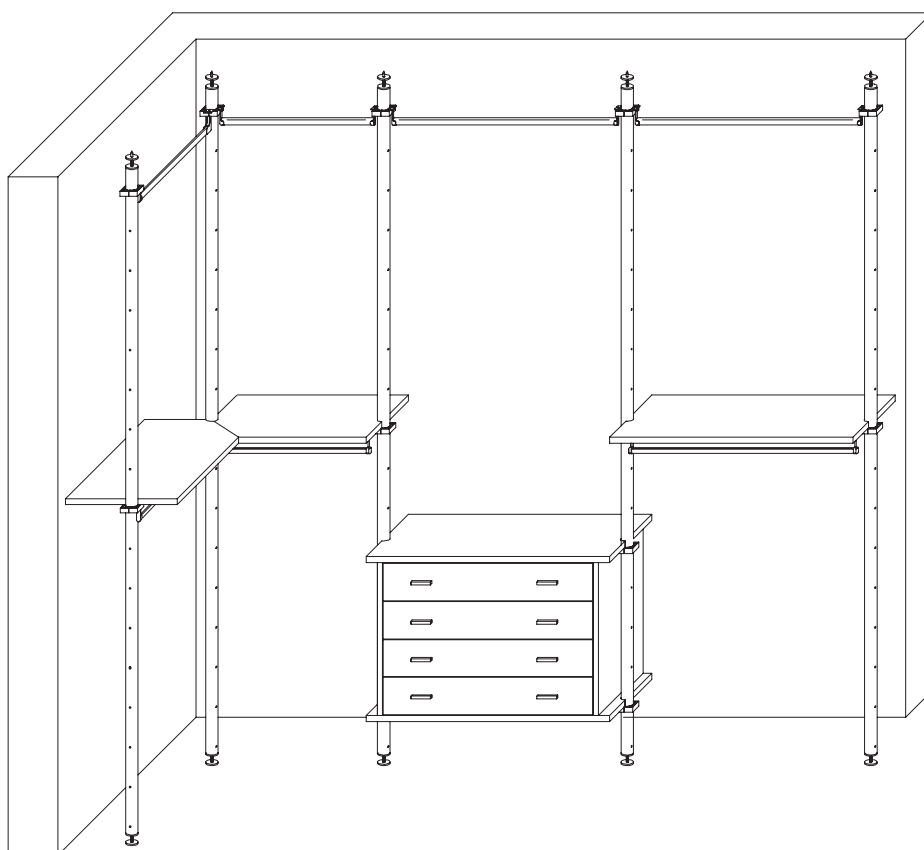
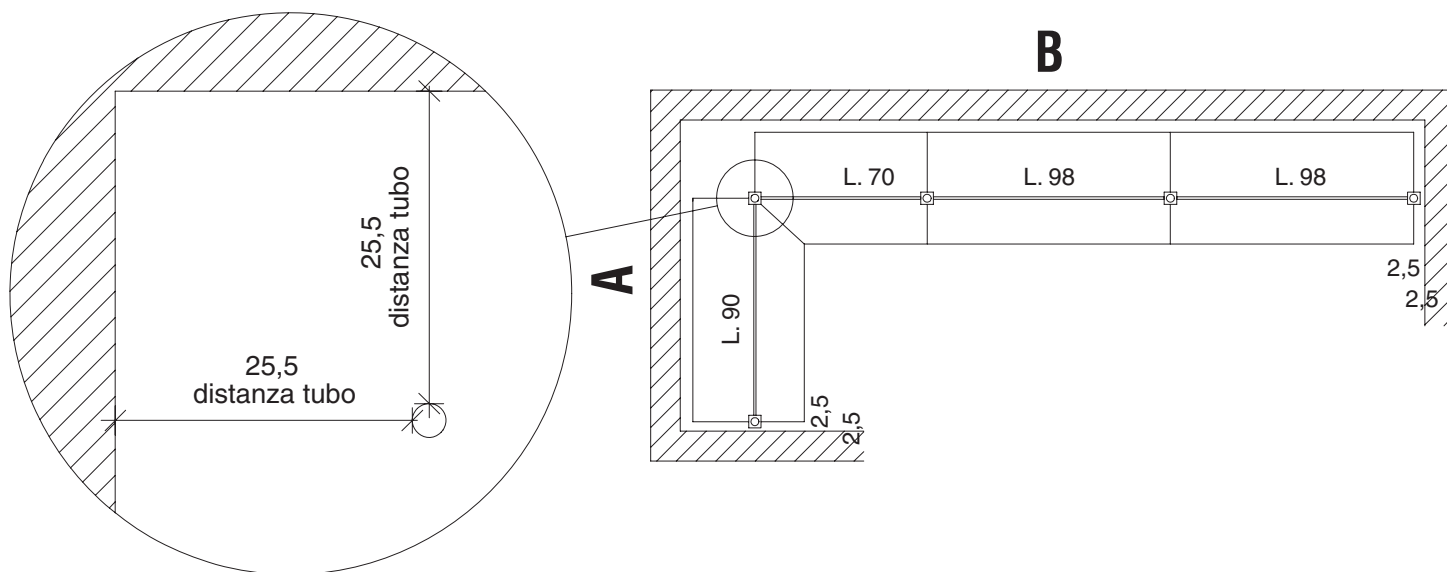

## INGOMBRI

### Profondità minima occorrente

- 1) Cabina armadio con ripiani prof. cm. 33 cm. 34
- 2) Cabina armadio con attrezzature prof. cm. 45 cm. 46
- 3) Cabina armadio con appenderia e attrezzatura prof. cm. 45 cm. 56

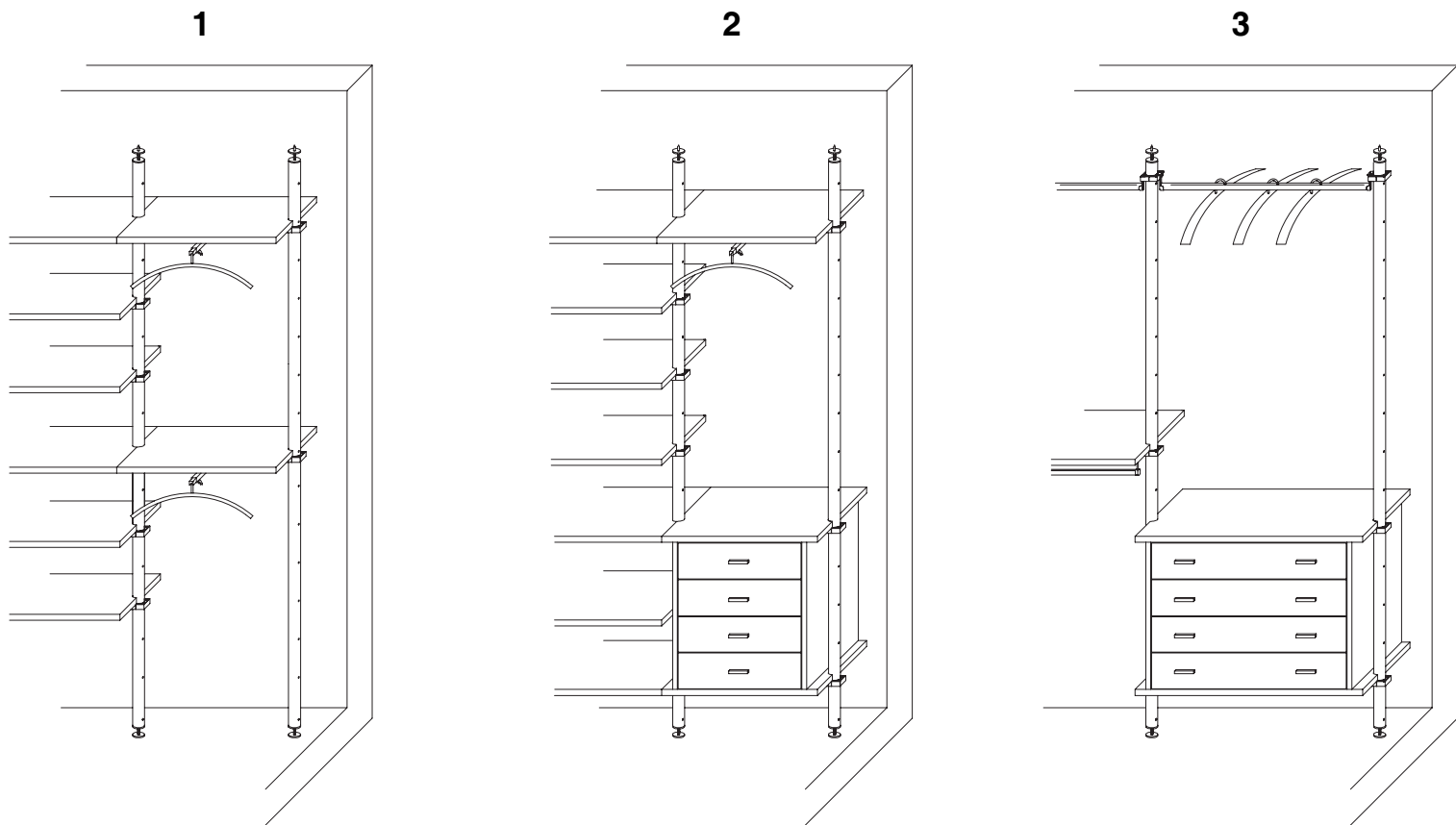

### Profondità minima occorrente

- 4) Cabina armadio con appenderia posteriore + appenderia anteriore a sbalzo cm. 103
- 5) Cabina armadio con doppia appenderia a tutta altezza cm. 110

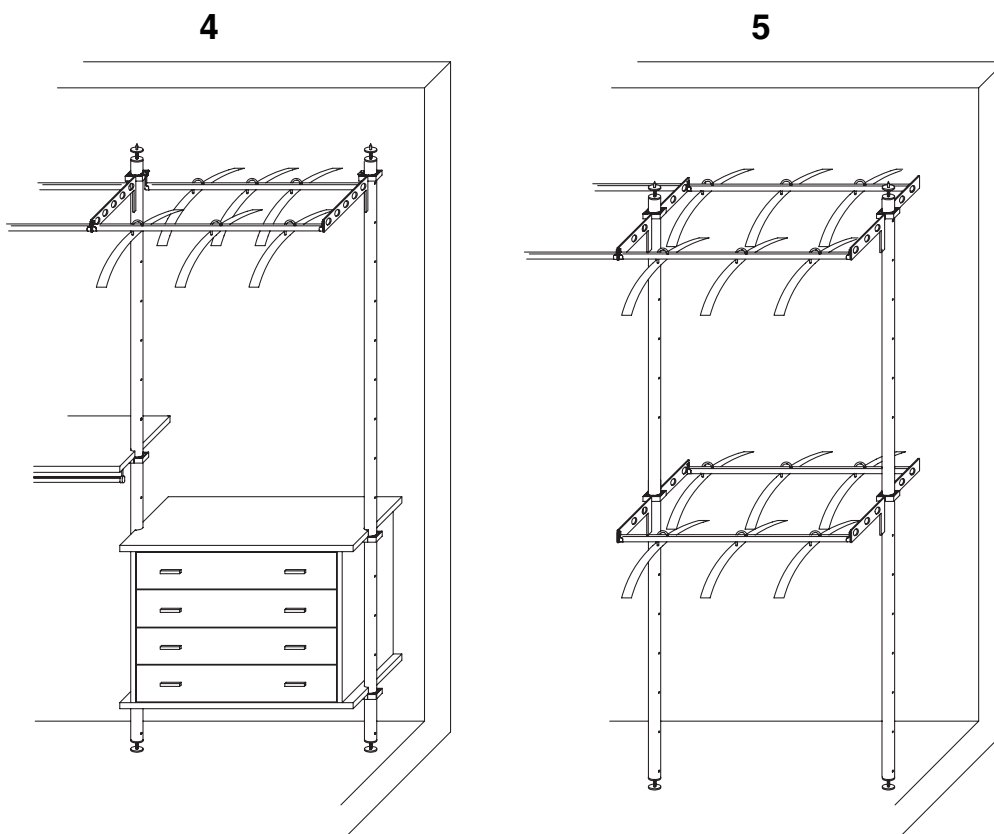

## I TUBI

È possibile posizionare i tubi in presenza di pedane con taglio del tubo superiore e inferiore, o in presenza di abbassamenti parziali di soffitto o travi a vista con un solo taglio superiore.

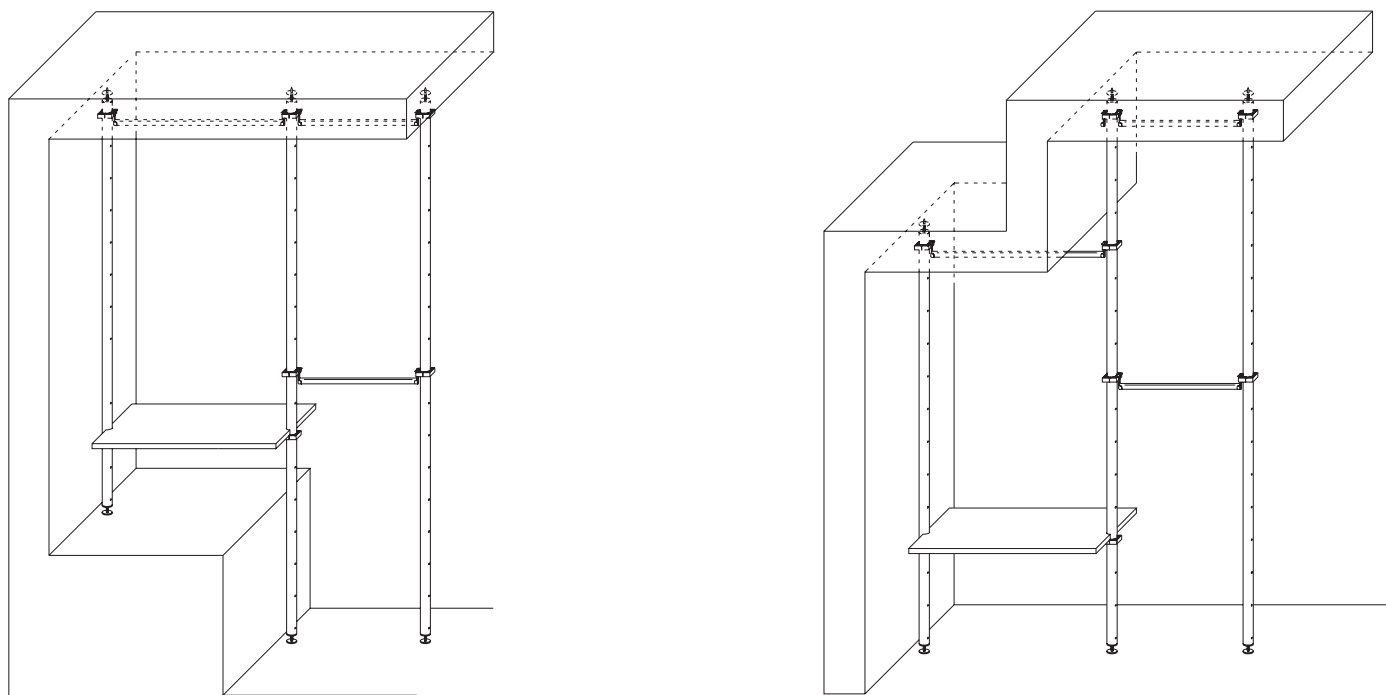

Anche nelle mansarde o sotto le arcate è possibile collocare i tubi. Senza supplemento di prezzo sono disponibili gli escursori a soffitto speciali con una corsa di cm. 15 e dischetti predisposti a seguire l'andamento del soffitto.

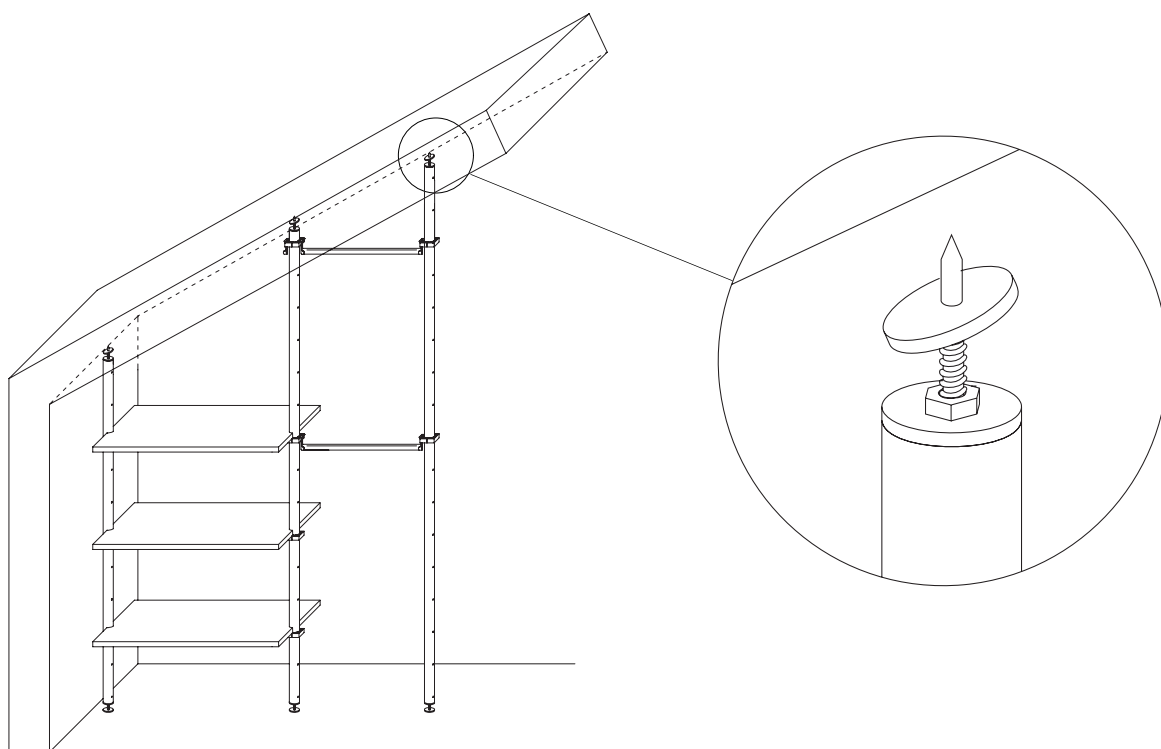

È possibile realizzare cabine armadio con cambio di profondità. In presenza di cambio di profondità, la distanza della tacca sui ripiani può variare in funzione dell'allineamento dei ripiani stessi.

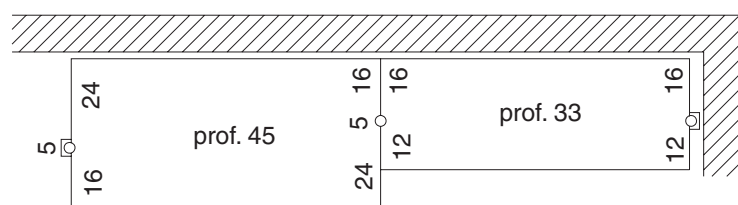

CAMBIO DI PROFONDITÀ ANTERIORE

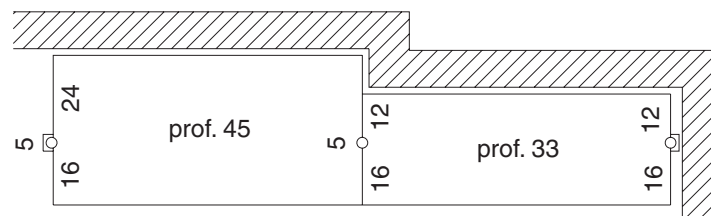

CAMBIO DI PROFONDITÀ POSTERIORE

# I TUBI

## TUBI Ø cm. 5 verniciati color alluminio

Non è possibile ricavare da un unico tubo due o più tubi.

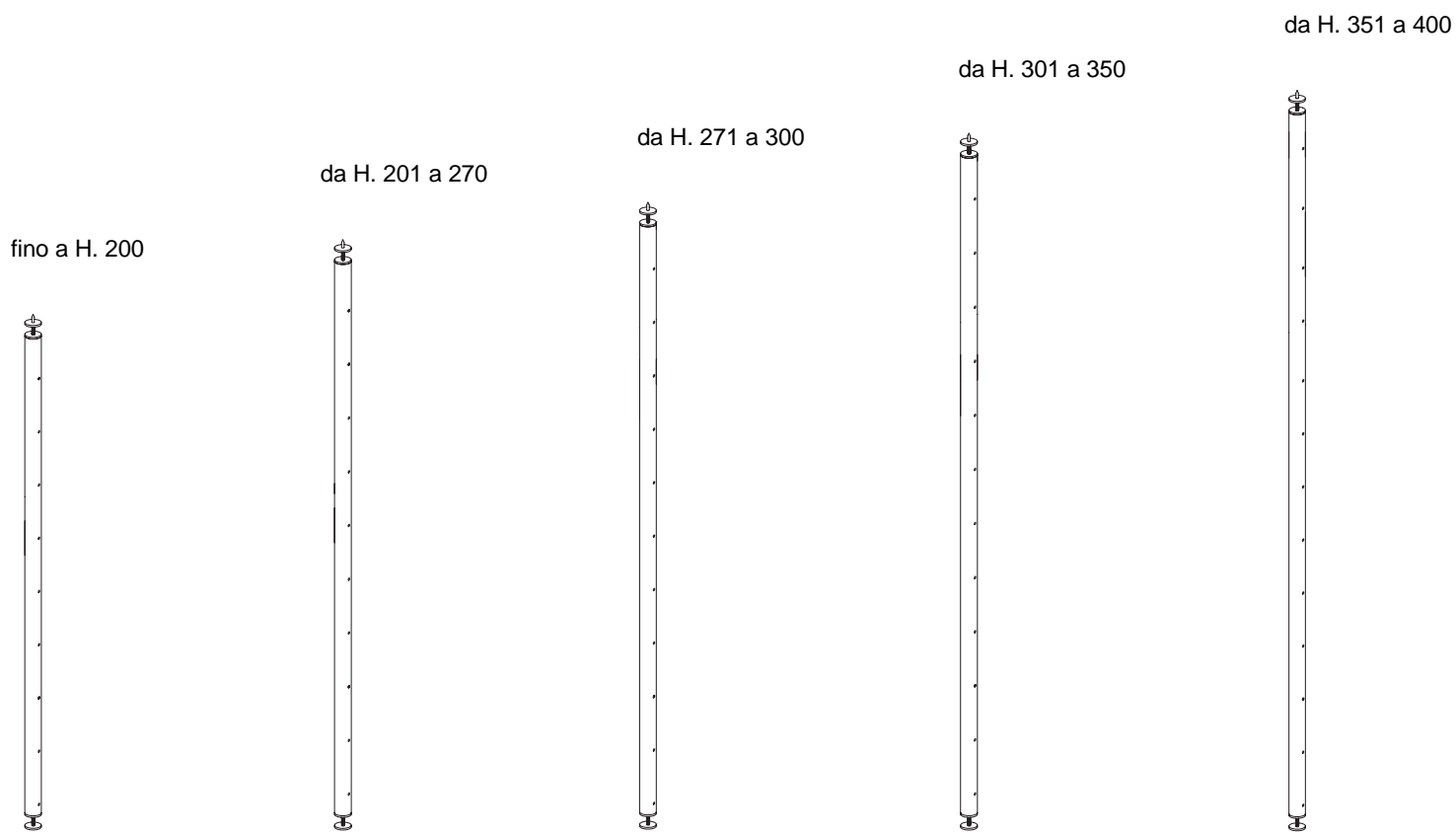

TU1	123	TU2	137	TU3	152	TU4	174	TU5	189
-----	-----	-----	-----	-----	-----	-----	-----	-----	-----

## GANASCE

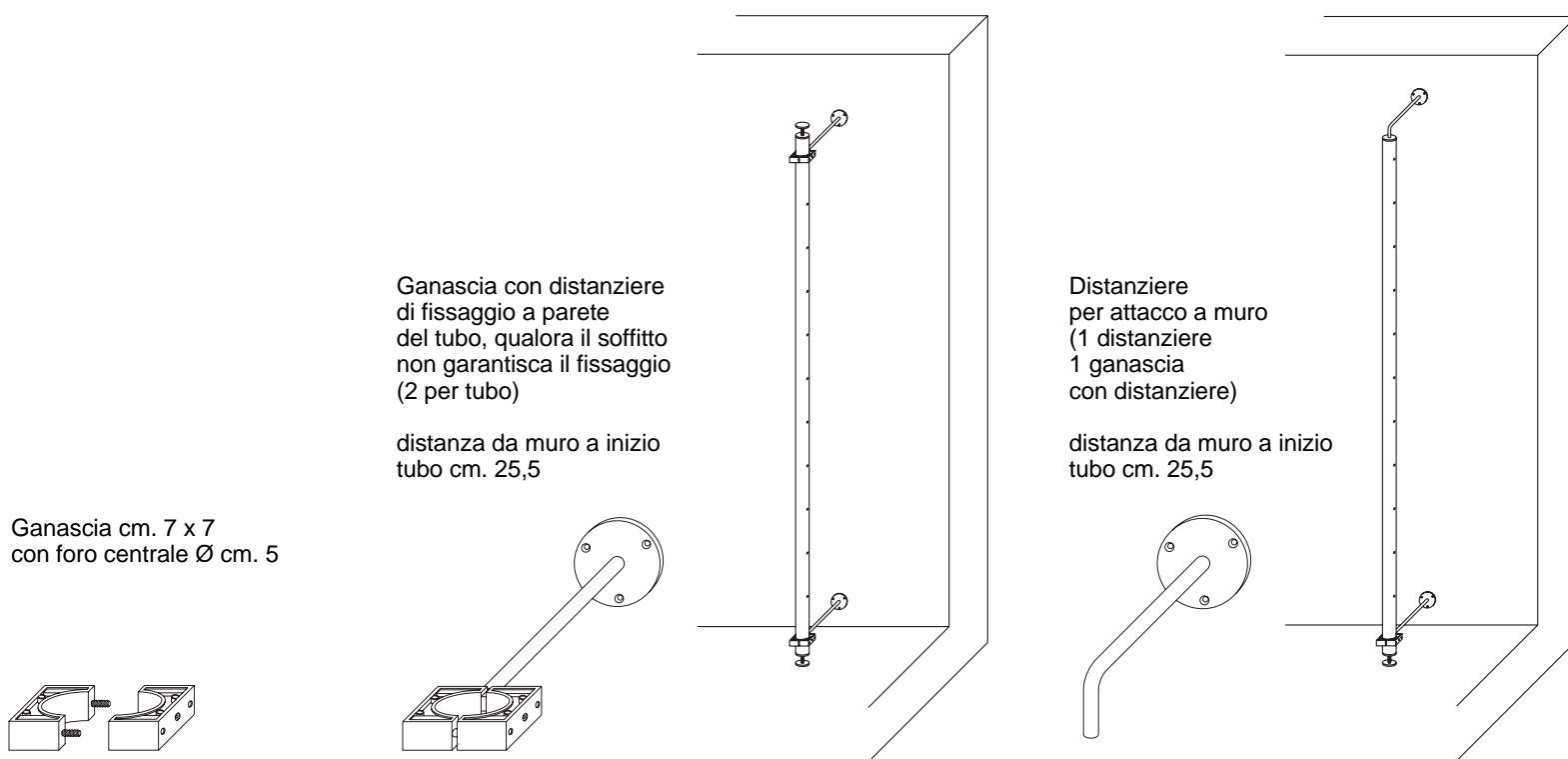

TU6	11	TU7	44	TU8	44
-----	----	-----	----	-----	----

# I TUBI

## TUBI Ø cm. 5 verniciati color grigio alluminio

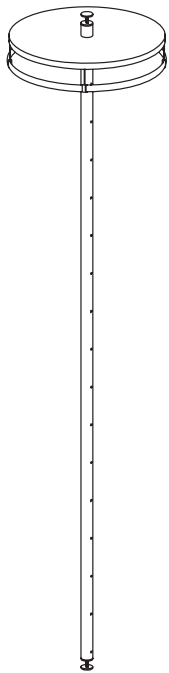

tubo fino a h. 300 con capitello per fissaggio a soffitto con un disco girevole Ø cm. 63 con una canna circolare

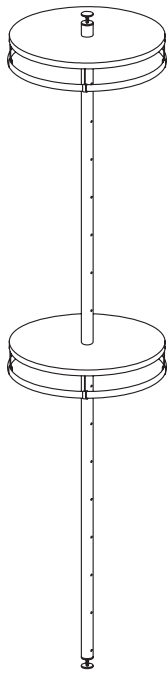

tubo fino a h. 300 con capitello per fissaggio a soffitto con due dischi girevoli Ø cm. 63 con due canne circolari

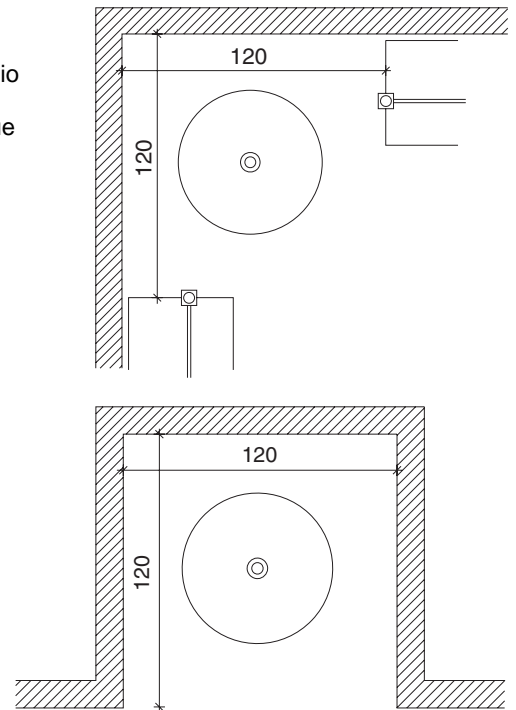

TU9	558	TU10	961
-----	-----	------	-----

## ANGOLARI - STAFFE DI FISSAGGIO TELESCOPICHE

In situazioni particolari, quali presenza di termosifone e porte, ove non è possibile l'uso del tubo iniziale o terminale è possibile fissare i ripiani in legno a parete tramite angolari in alluminio o staffe di fissaggio telescopiche. Tali situazioni richiedono particolare attenzione nel rilievo delle quote e nel montaggio della cabina armadio. In presenza di muri fuori squadra, i ripiani dovranno essere adattati sul posto.

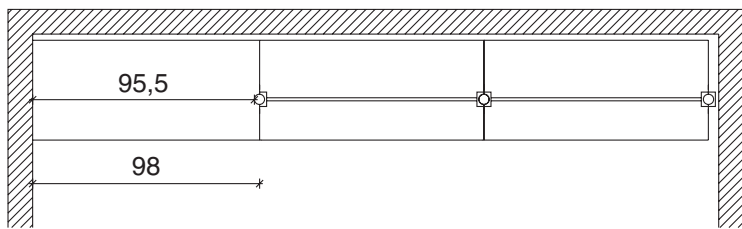

Angolari

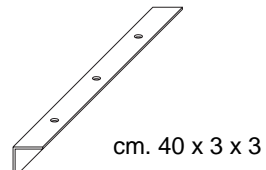
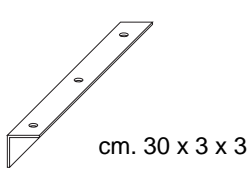

TU11	29	cad.	TU12	32	cad.
------	----	------	------	----	------

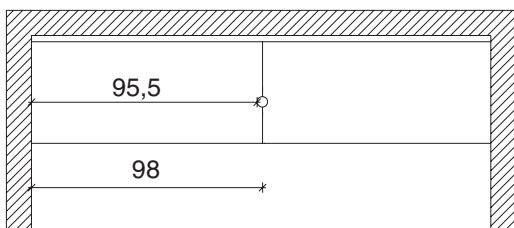
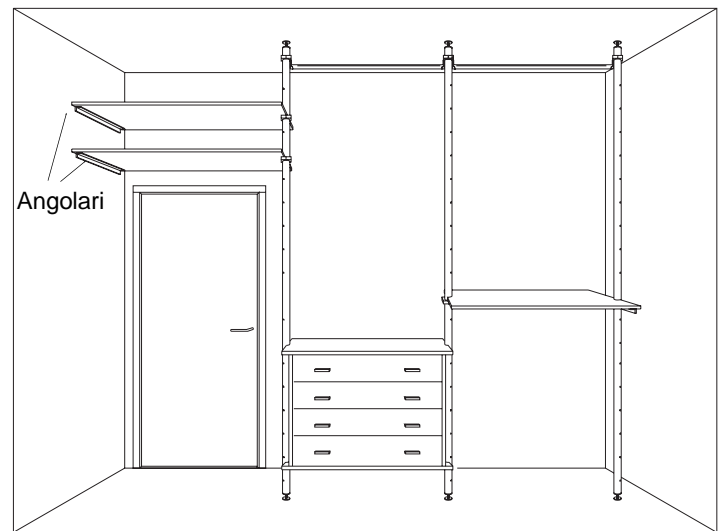

Staffe di fissaggio telescopiche

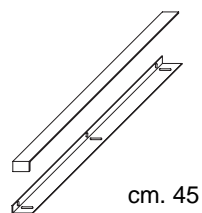
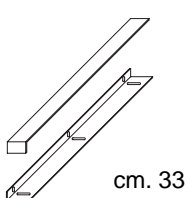

TUX33	40	cad.	TUX45	47	cad.
-------	----	------	-------	----	------

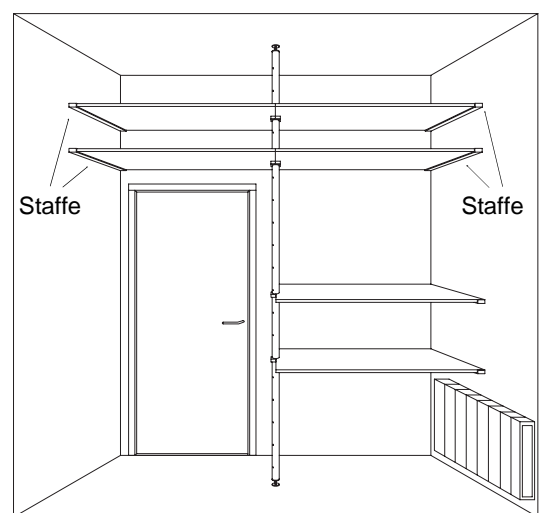



# I TUBI

Per il montaggio è necessario l'utilizzo delle ganasce

## CANNE APPENDIABILI

fino a L. 53

da L. 53,1 a 68

da L. 68,1 a 98

appendiabiti estraibile  
da fissare sotto al ripiano  
P. 33

appendiabiti estraibile  
da fissare sotto al ripiano  
P. 45

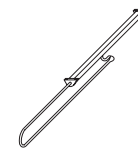
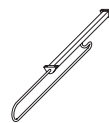

TU13	19	TU14	20	TU15	21	TU16	26	TU17	26
------	----	------	----	------	----	------	----	------	----

## CANNE APPENDIABILI con rinforzo

da L. 98,1 a 140

da L. 140,1 a 180

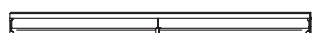

TU18	75	TU19	90
------	----	------	----

## APPENDIABITI SALISCENDI - Portata max. kg. 10

occorrono 4 ganasce

fino a L. 53

da L. 53,1 a 68

da L. 68,1 a 98

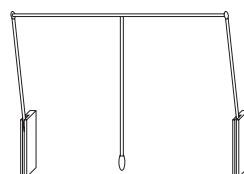
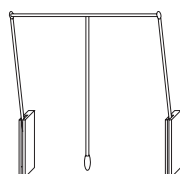
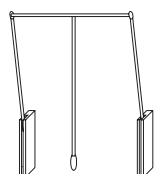

TU20	287	TU21	287	TU22	287
------	-----	------	-----	------	-----

## RIPIANI sp. 2,5 prof. 33

fino a L. 53

da L. 53,1 a 68

da L. 68,1 a 98



TU23	73	TU25	81	TU27	88			
TU24	108	Taglio 45°	TU26	121	Taglio 45°	TU28	126	Taglio 45°

## RIPIANI sp. 2,5 prof. 33 con rinforzo

da L. 98,1 a 140

da L. 140,1 a 180



TU29	172	TU31	193		
TU30	211	Taglio 45°	TU32	229	Taglio 45°

# I TUBI

Per il montaggio è necessario l'utilizzo delle ganasce

## RIPIANI sp. 2,5 prof. 45

fino a L. 53

da L. 53,1 a 68

da L. 68,1 a 98

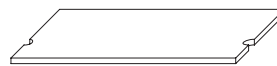
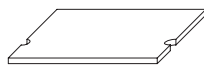

TU33	75		TU35	84		TU37	92	
TU34	110	Taglio 45°	TU36	123	Taglio 45°	TU38	129	Taglio 45°

## RIPIANI sp. 2,5 prof. 45 con rinforzo

da L. 98,1 a 140

da L. 140,1 a 180

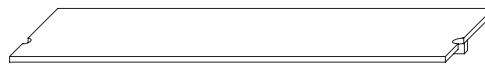
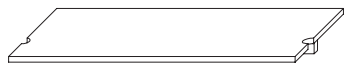

TU39	179		TU41	199	
TU40	215	Taglio 45°	TU42	238	Taglio 45°

## RIPIANI sp. 2,5 prof. 45 con canna appendiabiti

fino a L. 53

da L. 53,1 a 68

da L. 68,1 a 98

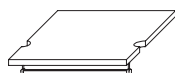

TU43	90		TU45	102		TU47	110	
TU44	127	Taglio 45°	TU46	140	Taglio 45°	TU48	150	Taglio 45°

## RIPIANI sp. 2,5 prof. 45 con canna appendiabiti e rinforzo

da L. 98,1 a 140

da L. 140,1 a 180

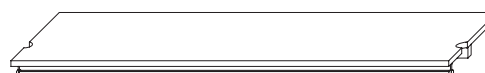
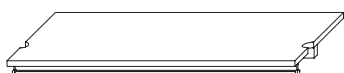

TU49	201		TU51	226	
TU50	240	Taglio 45°	TU52	265	Taglio 45°

## RIPIANI sp. 2,5 L. 98 prof. 45

ripiano inclinato portacamicie

ripiano con portapantaloni ad estrazione totale con BLUMOTION

ripiano scrittoio con portatastiera estraibile e portatower H. 51,5 P. 60 Laccato grigio alluminio

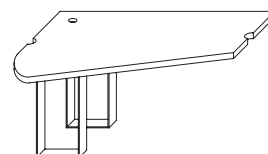
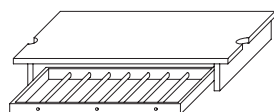
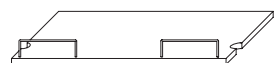

TU53	174		TU54	304		TU55	504	
------	-----	--	------	-----	--	------	-----	--

## PORTASCARPE ESTENSIBILE IN FILO DI FERRO prof. 55

fino a L. 98

Vaschetta per portascarpe estensibile (facoltativo)

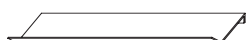
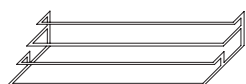

TU56	114		TU57	70	(cad.)
------	-----	--	------	----	--------

## I TUBI

Per il montaggio è necessario l'utilizzo delle ganasce

### CASSETTIERE SOSPESA ad estrazione totale con BLUMOTION H. 35,9 P. 45

occorrono 4 ganasce

L. 53

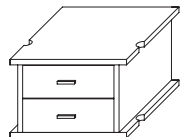

L. 68

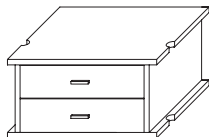

L. 98

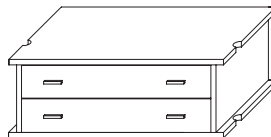

TU58 416

TU59 451

TU60 483

### CASSETTIERE SOSPESA ad estrazione totale con BLUMOTION H. 66,5 P. 45

occorrono 4 ganasce

L. 53

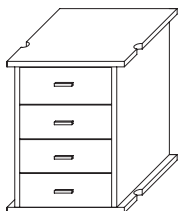

L. 68

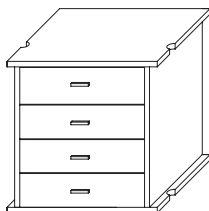

L. 98

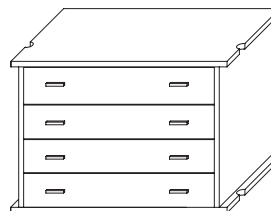

TU61 626

TU62 677

TU63 721

### CASSETTIERE SOSPESA ad estrazione totale con BLUMOTION H. 97,1 P. 45

occorrono 4 ganasce

L. 53

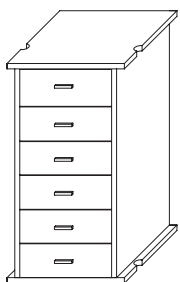

L. 68

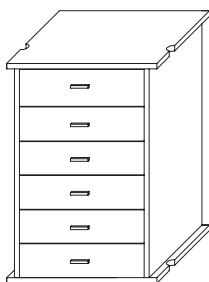

L. 98

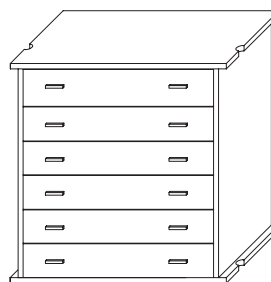

TU64 867

TU65 930

TU66 991

### CONTENITORI SOSPESI L. 98 P. 45

occorrono 4 ganasce

Portacamicie con  
4 ripiani in vetro  
H. 66,5

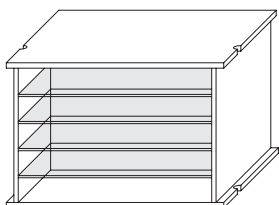

Serrandina con  
3 ripiani in vetro  
H. 97,1

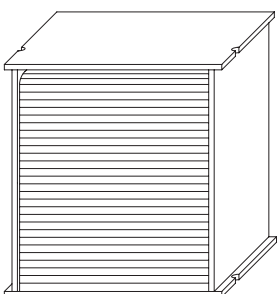

alveare  
H. 97,1

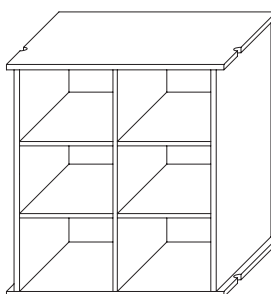

TU67 391

TU68 805

TU69 353

# I TUBI

Per il montaggio è necessario l'utilizzo delle ganasce

## ATTREZZATURE per tubo singolo fissaggio laterale

portacravatte  
L. 50 H. 9

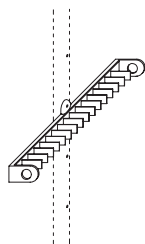

portacinture  
L. 50 H. 9

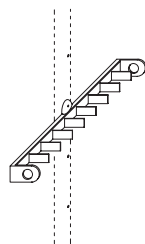

portagonne  
portapantaloni  
L. 50 - H. 9 - P. 20

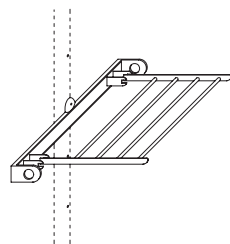

portascarpe  
(occorrono 2 ganasce)  
L. 48 H. 70 p. 22

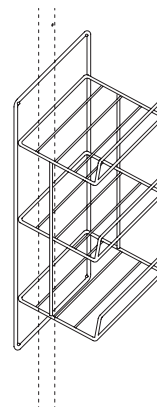

TU70	108	TU71	169	TU72	174	TU73	92
------	-----	------	-----	------	-----	------	----

porta appendiabiti  
L. 26

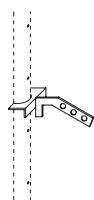

specchio estraibile  
e orientabile  
(occorrono 2 ganasce)  
L. 35 H. 150

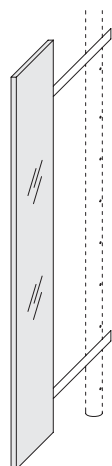

TU74	43	TU75	345
------	----	------	-----

## ATTREZZATURE per tubo singolo fissaggio frontale

svuotatasche  
L. 30 H. 15 p. 10

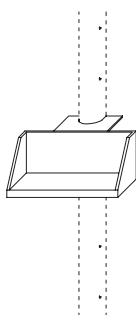

porta appendiabiti

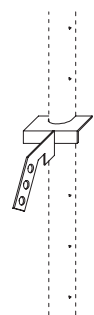

specchio su pannello  
(occorrono 2 ganasce)  
L. 42 H. 160



pannello con 3 pomoli -  
specchio e svuotatasche  
(occorrono 2 ganasce)  
L. 42 H. 160

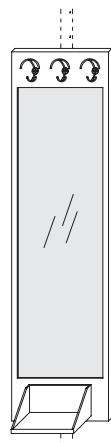

pannello con 3 pomoli -  
portacinture e svuotatasche  
(occorrono 2 ganasce)  
L. 42 H. 160

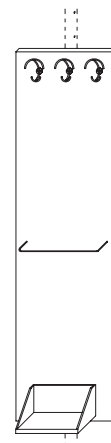

TU76	56	TU77	35	TU78	175	TU79	261	TU80	210
------	----	------	----	------	-----	------	-----	------	-----

## I TUBI

### CASSETTIERE SU RUOTE ad estrazione totale con BLUMOTION H. 42,1 P. 45

L. 45

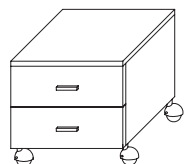

L. 60

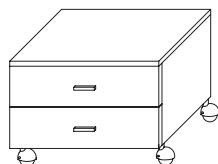

L. 90



TU81 437

TU82 471

TU83 508

### CASSETTIERE SU RUOTE ad estrazione totale con BLUMOTION H. 72,7 P. 45

L. 45

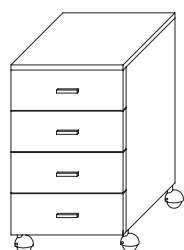

L. 60



L. 90

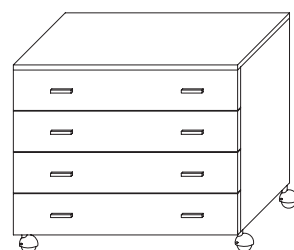

TU84 640

TU85 691

TU86 739

### CASSETTIERE SU RUOTE ad estrazione totale con BLUMOTION H. 103,3 P. 45

L. 45

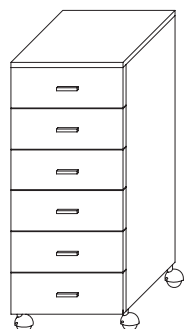

L. 60

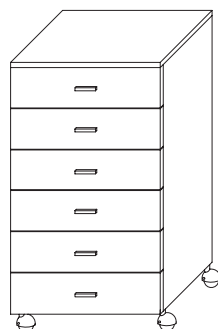

L. 90



TU87 898

TU88 963

TU89 1.030

## ELEMENTI SU RUOTE

cesto portabiancheria  
in filo di ferro  
L. 45 H. 57,5 P. 43

ripiano portascatoie  
L. 90 H. 18,5 P. 45

contenitore in lamiera  
L. 90 H. 34,7 P. 45

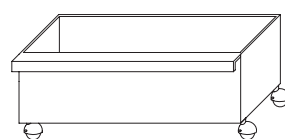
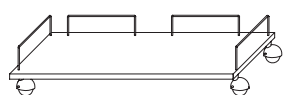
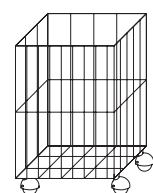

TU90 94

TU91 138

TU92 317

# I TUBI

## ELEMENTI SU RUOTE

serrandina con  
3 ripiani in vetro  
L. 90 H. 103,3 P. 45

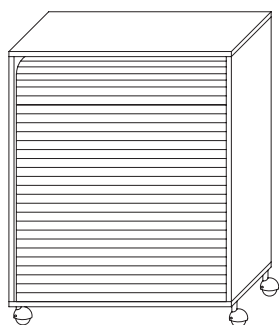

alveare  
L. 90 H. 103,3 P. 45

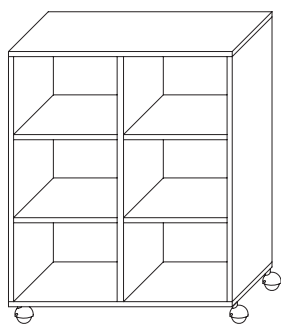

TU93	841	TU94	390
------	-----	------	-----

## ATTREZZATURE da fissare a parete con viti

mensola  
sp. 2,5 p. 33  
al metro lineare

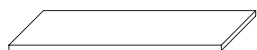

coppia  
reggimensola  
color grigio



pomolo  
appendiabiti



svuotatasche  
L. 30 H. 15 P. 10

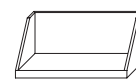

TU95	84	TU96	21	TU97	17	TU98	51
------	----	------	----	------	----	------	----

staffa appendiabiti  
L. 28



portacravatte  
L. 50 h. 9



portacinture  
L. 50 h. 9



portagonne  
portapantaloni  
L. 50 - H. 9 - P. 20

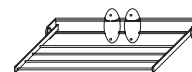

TU99	76	TU100	81	TU101	140	TU102	148
------	----	-------	----	-------	-----	-------	-----

portascarpe estensibile  
in filo di ferro P.20  
L. 67/115



Vaschetta per  
portascarpe estensibile  
(facoltativo)

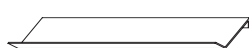

portascarpe  
L. 48 H. 70 P. 22

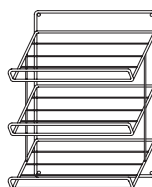

specchio  
L. 36 H. 160



TU103	47	TU104	70	TU105	84	TU106	94
-------	----	-------	----	-------	----	-------	----

# I TUBI

Per il montaggio è necessario l'utilizzo delle ganasce

Le staffe permettono di realizzare la doppia appenderia.

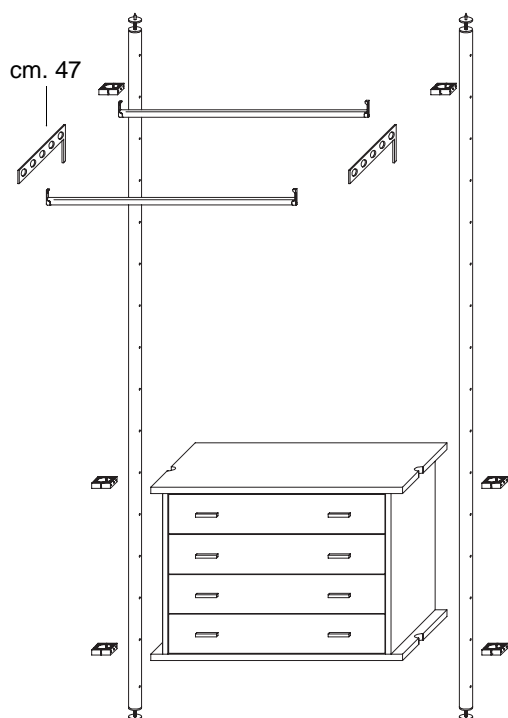

2 staffe con 1 canna appendiabiti  
fino a L. 93 (occorrono 2 ganasce)

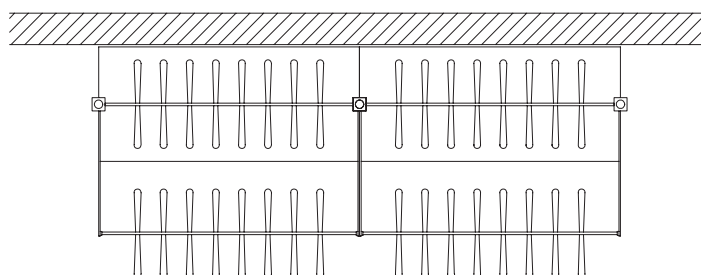

3 staffe con 2 canne appendiabiti  
da L. 126,2 a 186 (occorrono 3 ganasce)

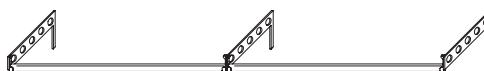

TU107 152

TU108 237

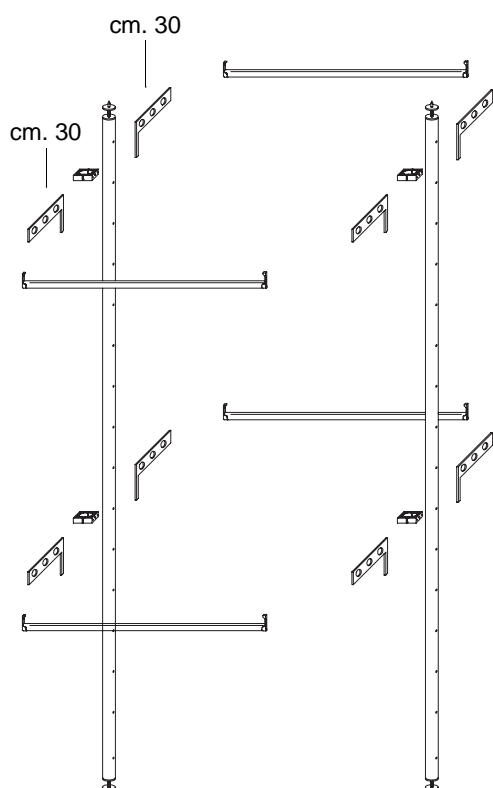

4 staffe con 2 canne appendiabiti  
fino a L. 93 (occorrono 2 ganasce)

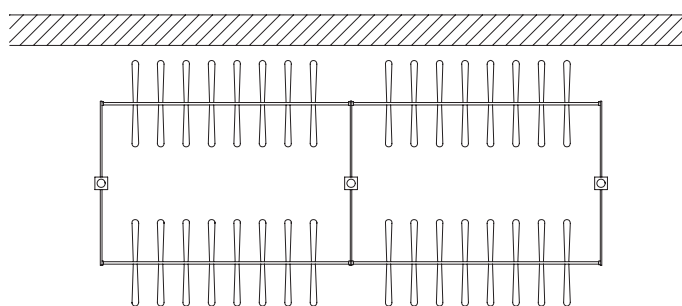
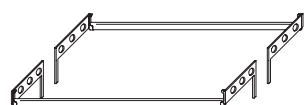

6 staffe con 4 canne appendiabiti  
da L. 126,2 a 186 (occorrono 3 ganasce)

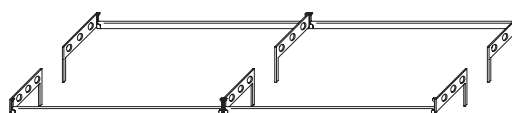

TU109 238

TU110 375

**PIASTRA ANGOLARE DI RACCORDO 0° - 90° - 180° per canne appendiabiti (in dotazione).**

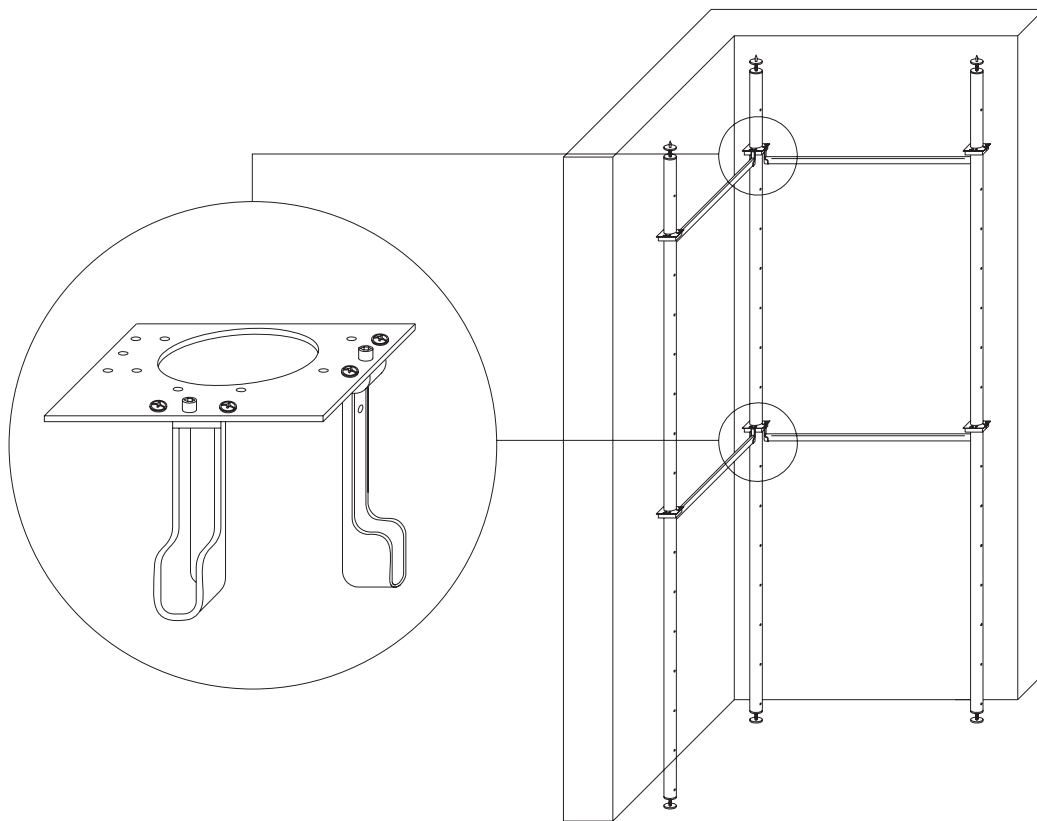

**PIASTRA OSCILLANTE 20 x 10 per il libero posizionamento delle canne appendiabiti da 0° a 180° in presenza di pareti fuori squadra.**

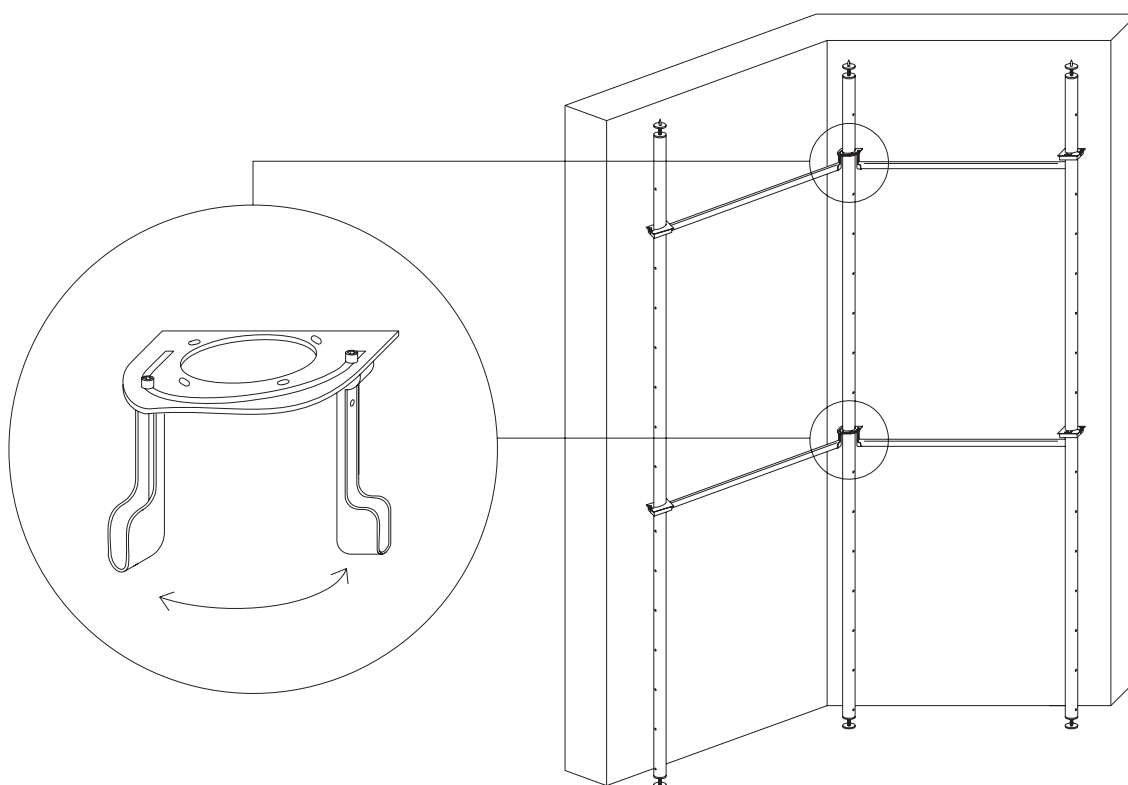



## CARRELLI SCORREVOLI FLOOR L. 96 H. 200/307

### INGOMBRI

Carrello scorrevole con ripiani prof. 33  
Profondità minima occorrente cm. 33

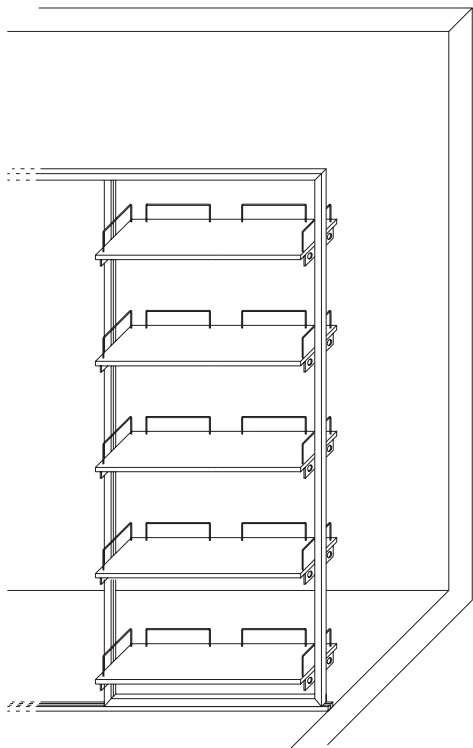

Carrello scorrevole con canne appendiabiti  
Profondità minima occorrente cm. 53

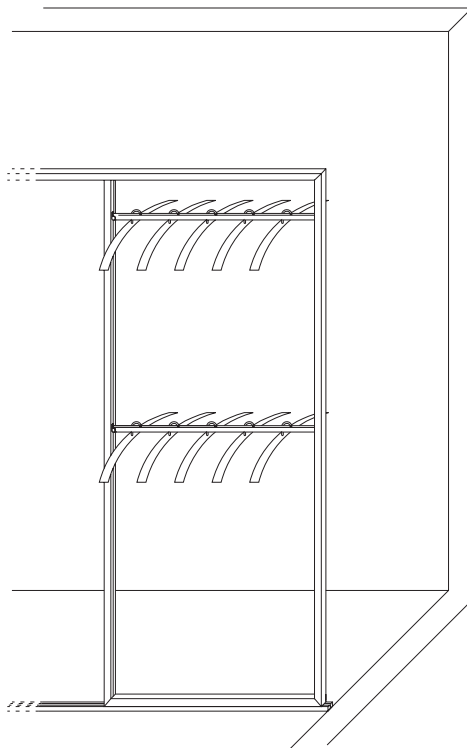

Carrello scorrevole con canna appendiabiti e ripiani prof. 33  
Profondità minima occorrente cm. 53

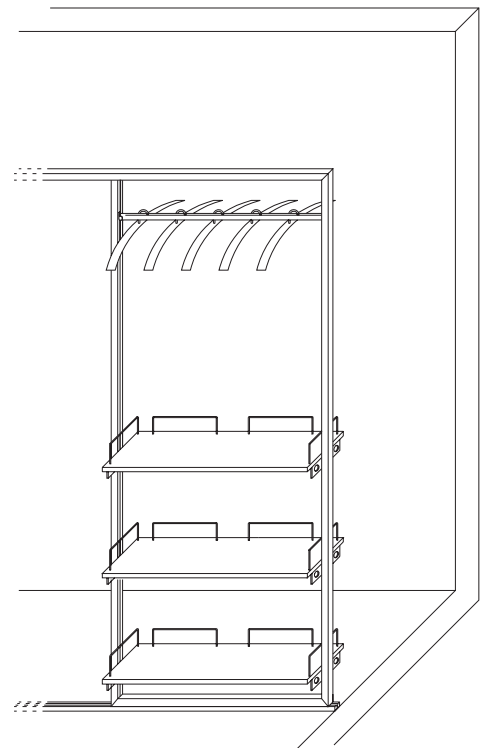

### Il carrello scorrevole può essere collocato davanti ad una cabina armadio

Cabina armadio posteriore con carrello scorrevole con ripiani prof. cm. 33  
Profondità minima occorrente cm. 91

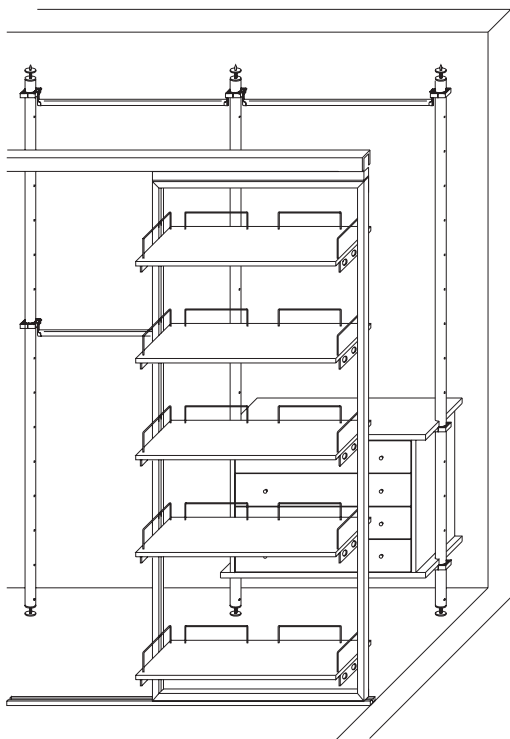

Cabina armadio posteriore con carrello scorrevole con appenderia  
Profondità minima occorrente cm. 120

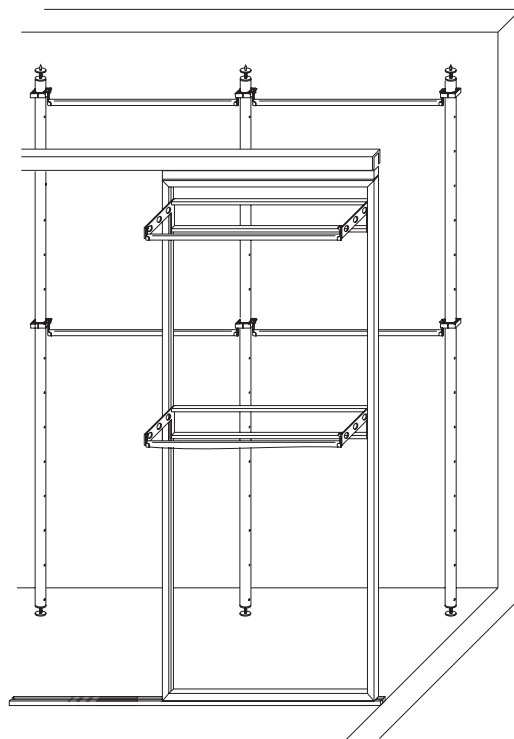

Cabina armadio posteriore con carrello scorrevole con appenderia e ripiani prof. cm. 33  
Profondità minima occorrente cm. 120

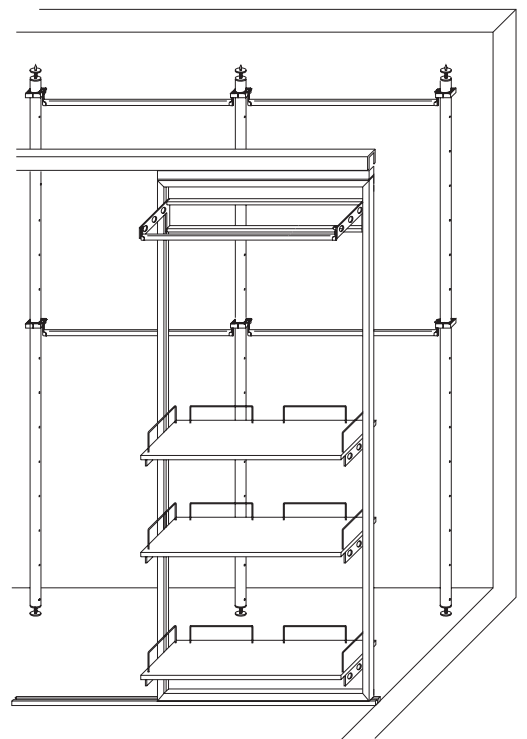

## CARRELLO SCORREVOLE FLOOR L. 96 H. 200/307

	<p>carrello scorrevole con 5 ripiani p. 33</p>	<p>carrello scorrevole con 2 canne appendiabiti</p>	<p>carrello scorrevole con 1 canna appendiabiti e 3 ripiani p. 33</p>
	<p><b>TU121</b>    1.035</p>	<p><b>TU122</b>    591</p>	<p><b>TU123</b>    872</p>

	<p>carrello scorrevole con 5 ripiani p. 33</p>	<p>carrello scorrevole con 2 appendierie</p>	<p>carrello scorrevole con 1 appendieria e 3 ripiani p. 33</p>
	<p><b>TU124</b>    1.035</p>	<p><b>TU125</b>    955</p>	<p><b>TU126</b>    1.053</p>

canna appendiabiti  
L. 90

appendieria  
L. 90

ripiano con protezioni  
laterali e posteriori  
L. 89,5 p. 33

binario superiore e inferiore

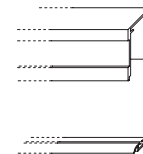
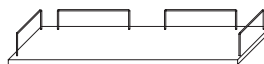
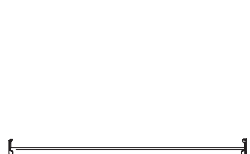

<b>TU127</b> 64	<b>TU128</b> 246	<b>TU129</b> 117	<b>TU130</b> 96	al ml.
-----------------	------------------	------------------	-----------------	--------

# I TUBI

## COMPOSIZIONI

Aggiungere cm. 2,5 per lato necessari per il montaggio.  
I prezzi si intendono riferiti a composizioni con tubi H. cm. 270.

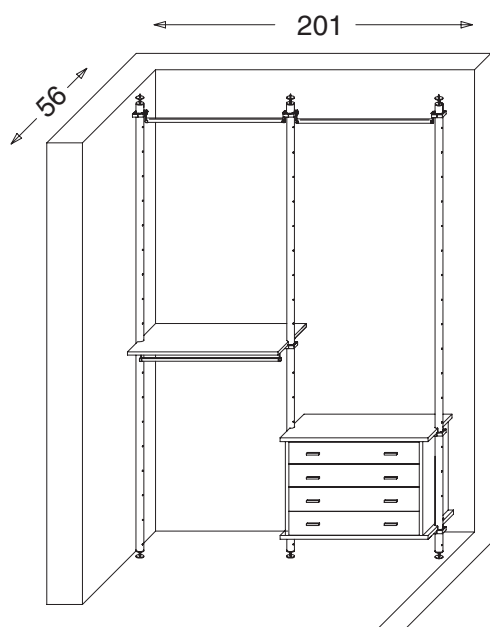

**TU131** 1.355

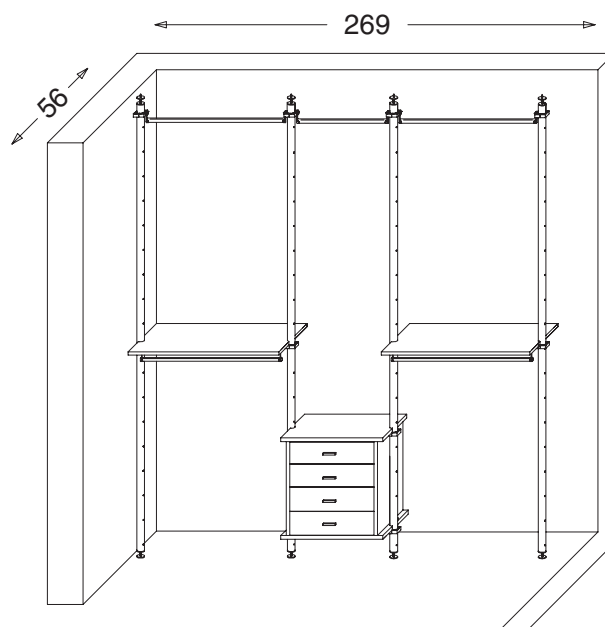

**TU132** 1.600

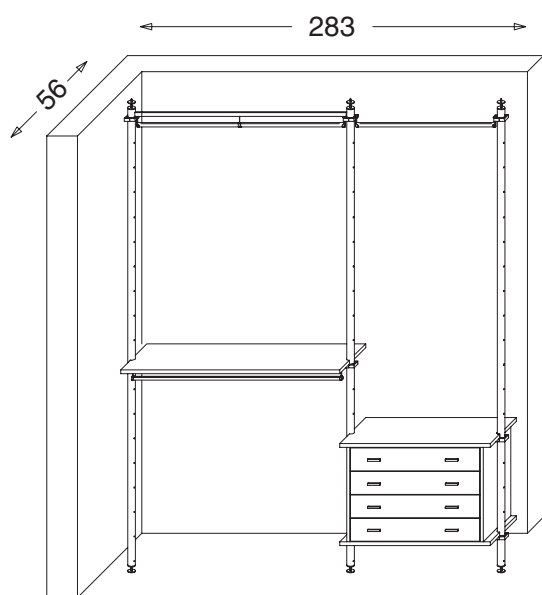

**TU133** 1.541

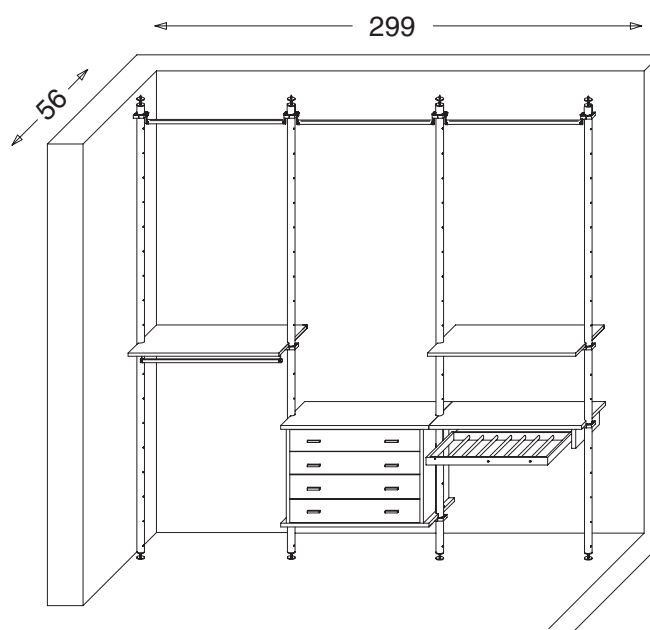

**TU134** 1.938

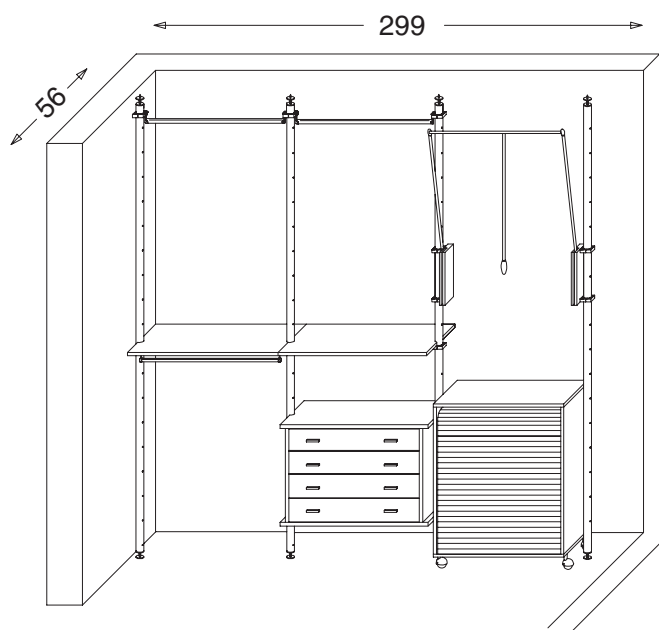

**TU135** 2.749

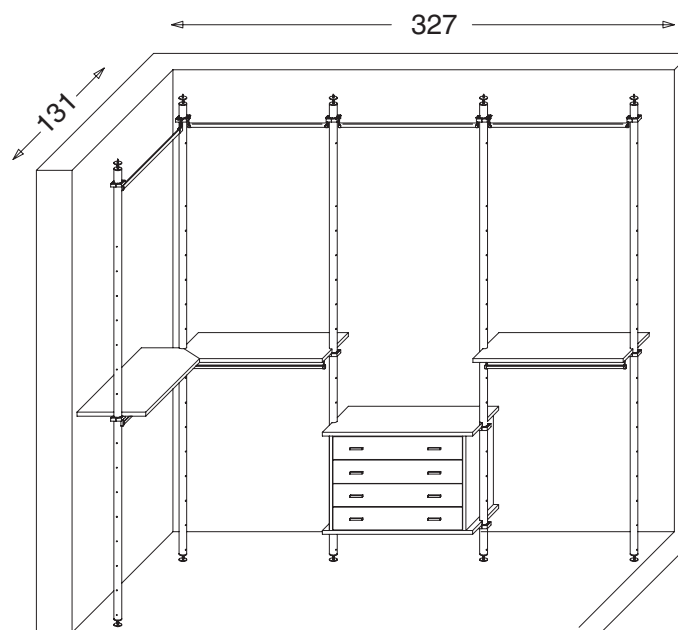

**TU136** 2.005

# ICON

La cabina armadio ICON è un sistema alternativo al solito armadio.

La cabina armadio ICON è costituita da telai in alluminio attrezzati con ripiani, cassettiere e canne appendiabiti. Data la robustezza dei telai autoportanti unita alla rigidità delle attrezzature rinforzate, si consiglia di realizzare composizioni con campate fino a cm. 150 in larghezza.

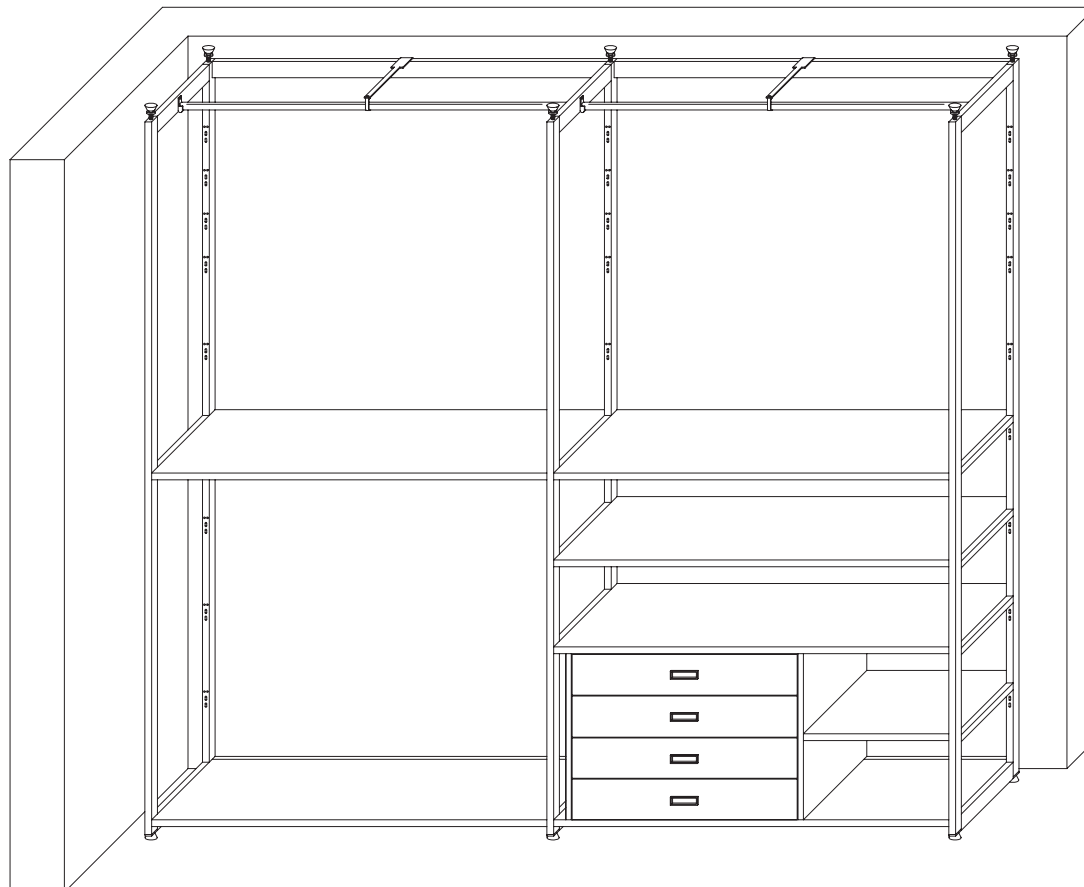

## FINITURE

- Nobilitato bianco
- Nobilitato grigio tessuto
- Nobilitato canapa tessuto
- Nobilitato larice bianco
- Nobilitato larice termo
- Nobilitato olmo urbano

A richiesta, le attrezzature interne possono essere fornite in finitura laccato opaco scala RAL, NCS, al campione. Contattare il Ns. Ufficio Tecnico per specifiche tecniche e preventivi.

**TELAIO IN ALLUMINIO**

H. fino a cm. 308 p. cm. 56,2 sp. cm. 2,5

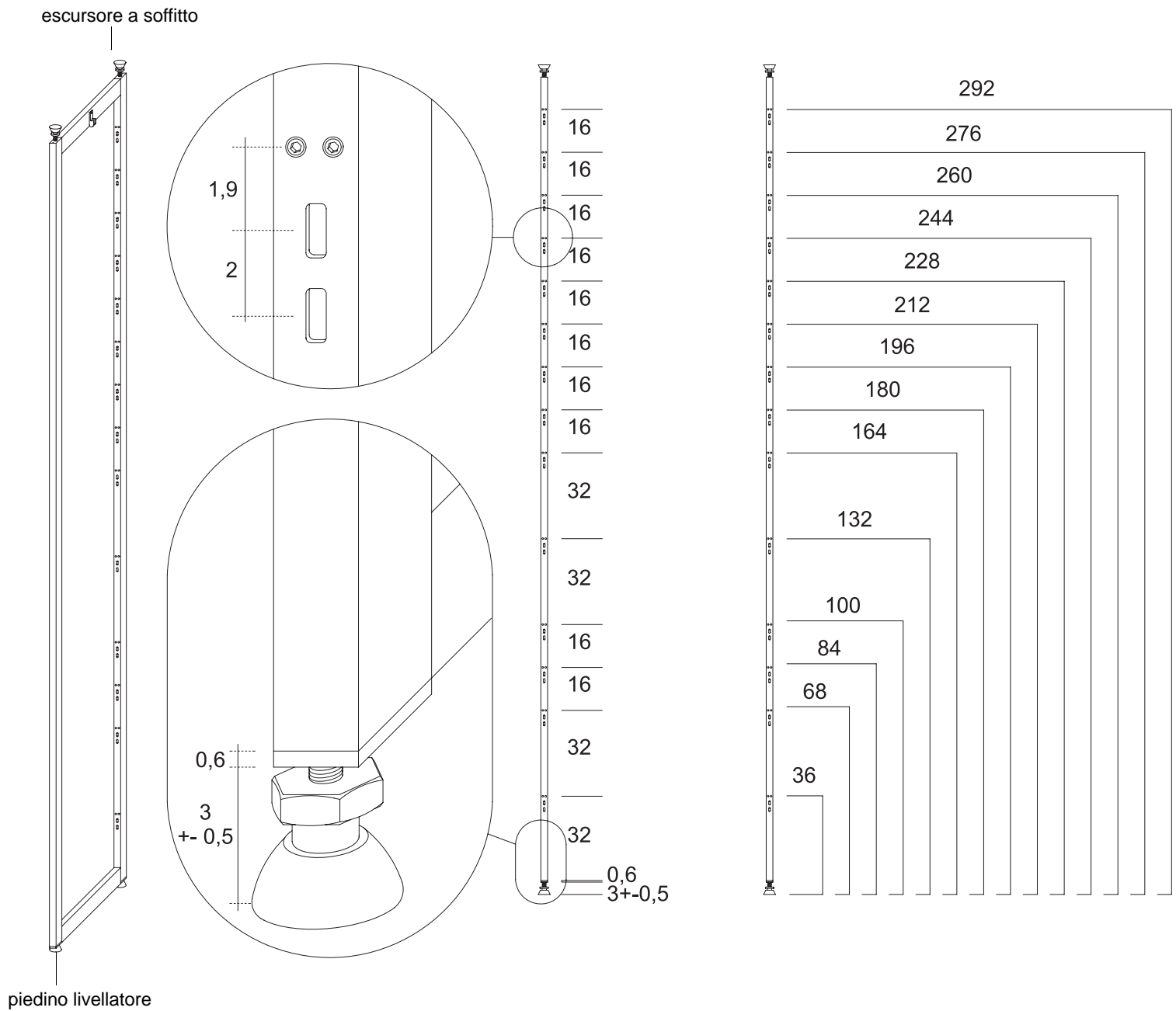

**RIPIANI sp. cm. 2,5**

I ripiani sono sempre realizzati su misura.

**LARGHEZZA**

fino a L. 150

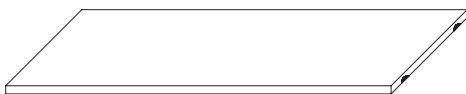

**PROFONDITÀ**

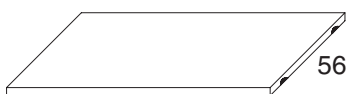

La profondità del ripiano è di cm. 56,2, mentre quella del basamento è di cm. 53,7

**TELAIO IN ALLUMINIO**

sp. cm. 2,5

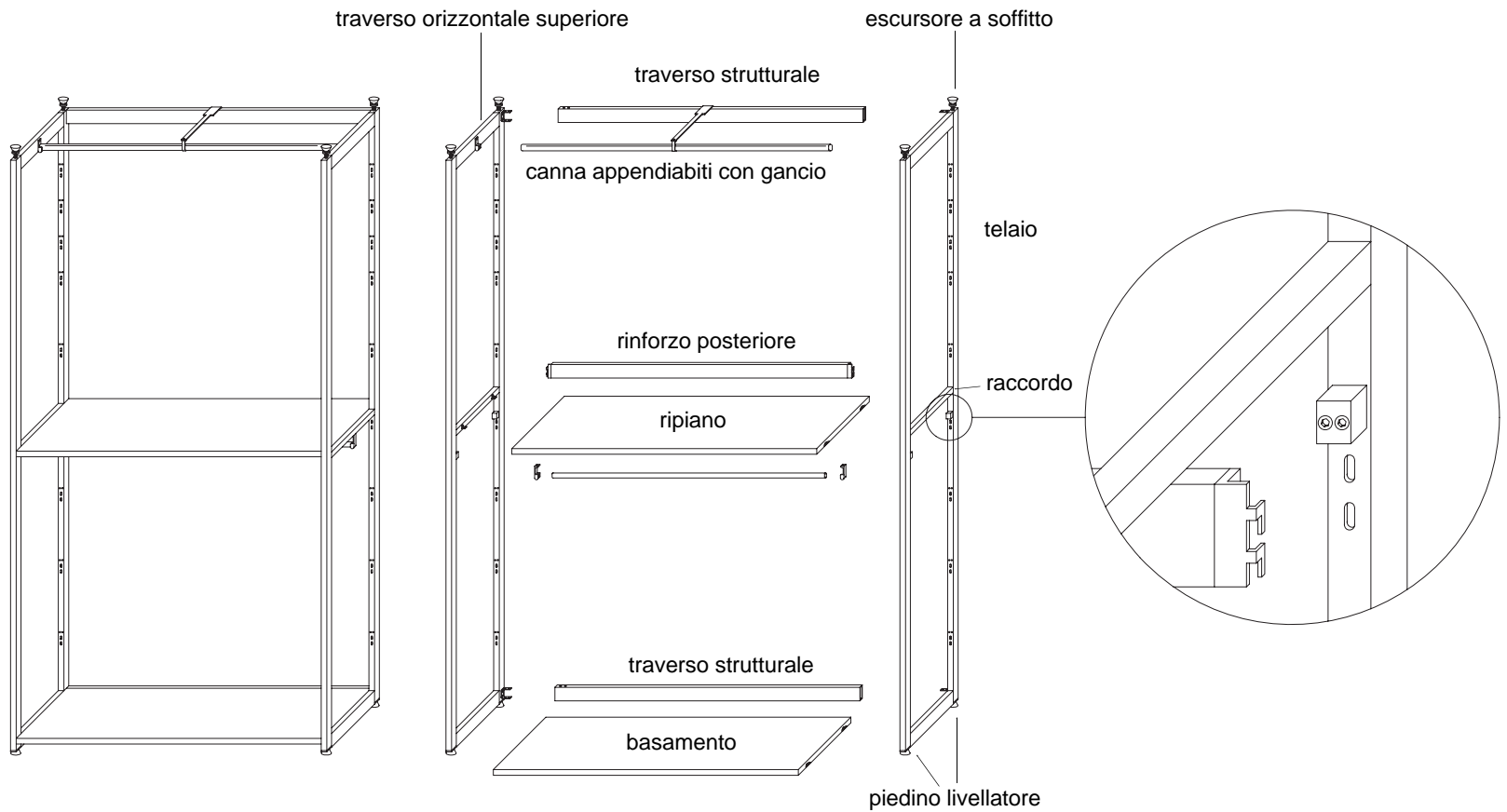

**RACCORDI**

Il raccordo, un tubolare cm. 2,5 x 2,5, viene fissato al telaio mediante due blocchetti in alluminio ed è indispensabile per il posizionamento dei ripiani.

Il raccordo è predisposto con foratura su un lato per i telai iniziale e terminale, e con foratura su due lati per i telai centrali.

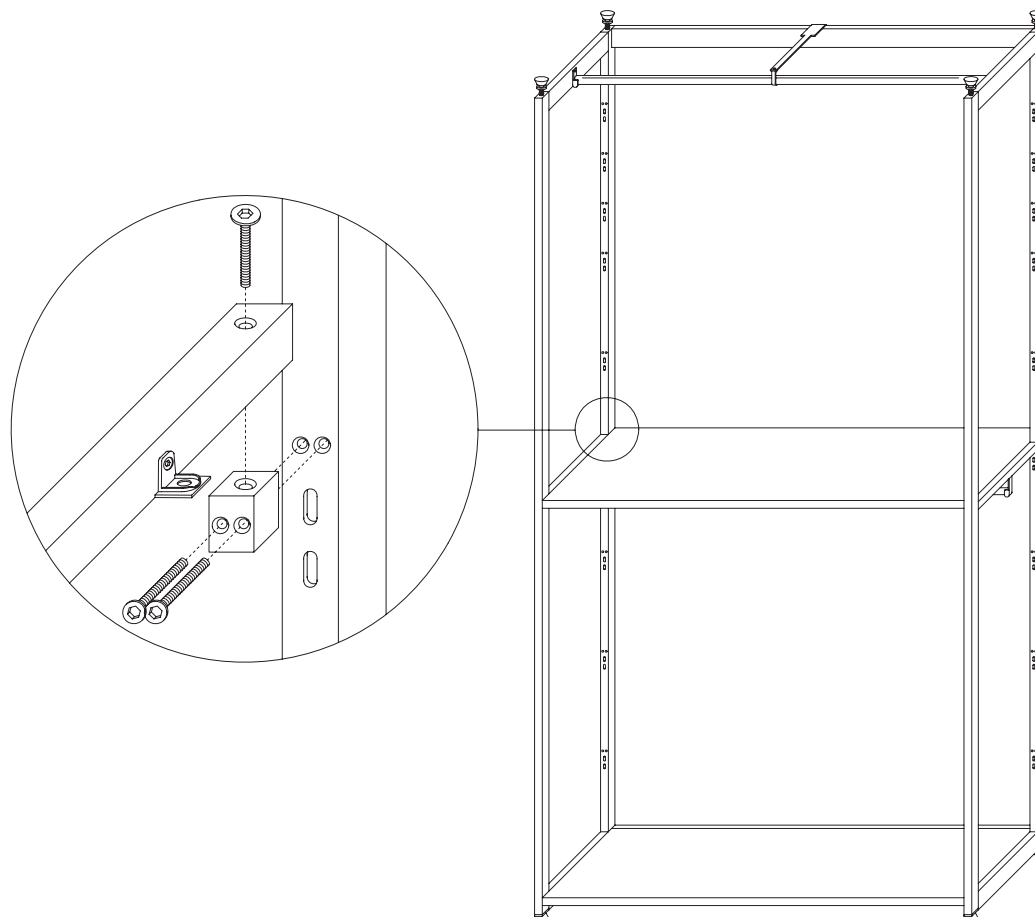



**COMPOSIZIONI ANGOLARI**

Le composizioni angolari sono realizzate con l'utilizzo di un telaio appositamente studiato.

**ISTRUZIONI PER CALCOLARE CORRETTAMENTE LE MISURE IN LARGHEZZA**

ESEMPIO DI PARETE L. cm. 130 x 235

PARETE A: cm. 2 + 2,5 + 124,5 + 1 = cm. 130

PARETE B: cm. 1 + 130,6 + 2,5 + 96,4 + 2,5 + 2 = cm. 235

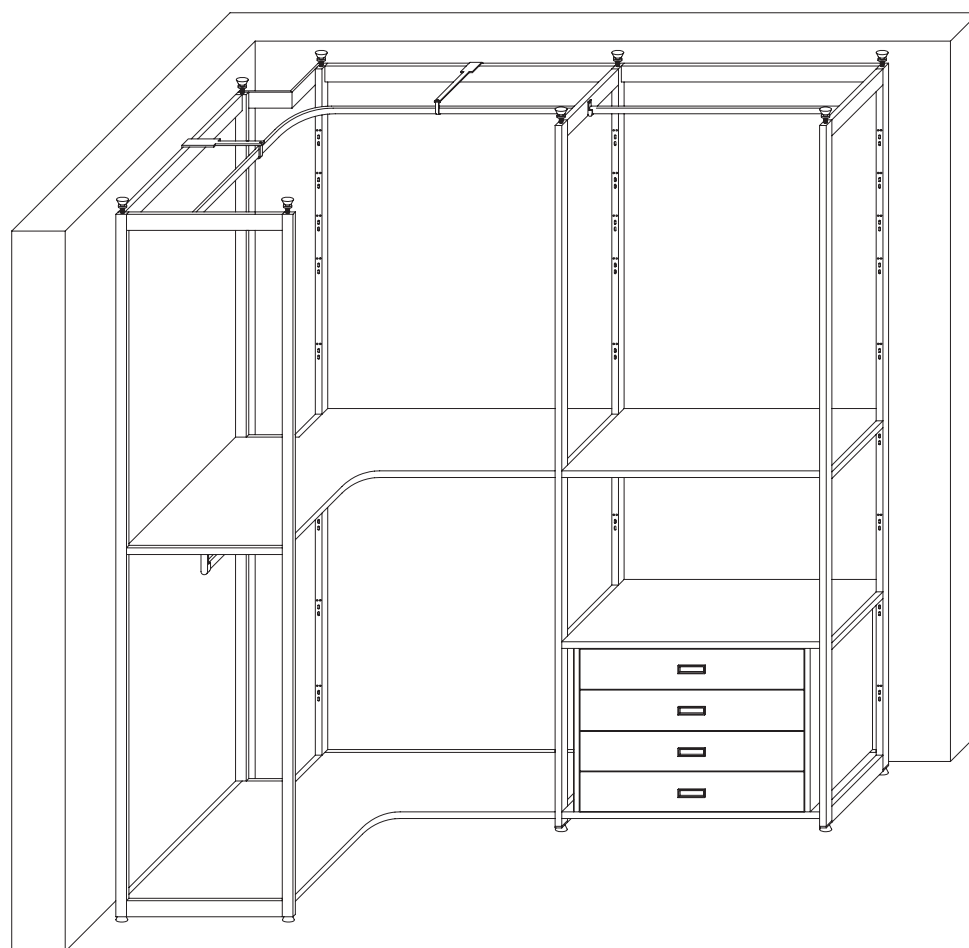
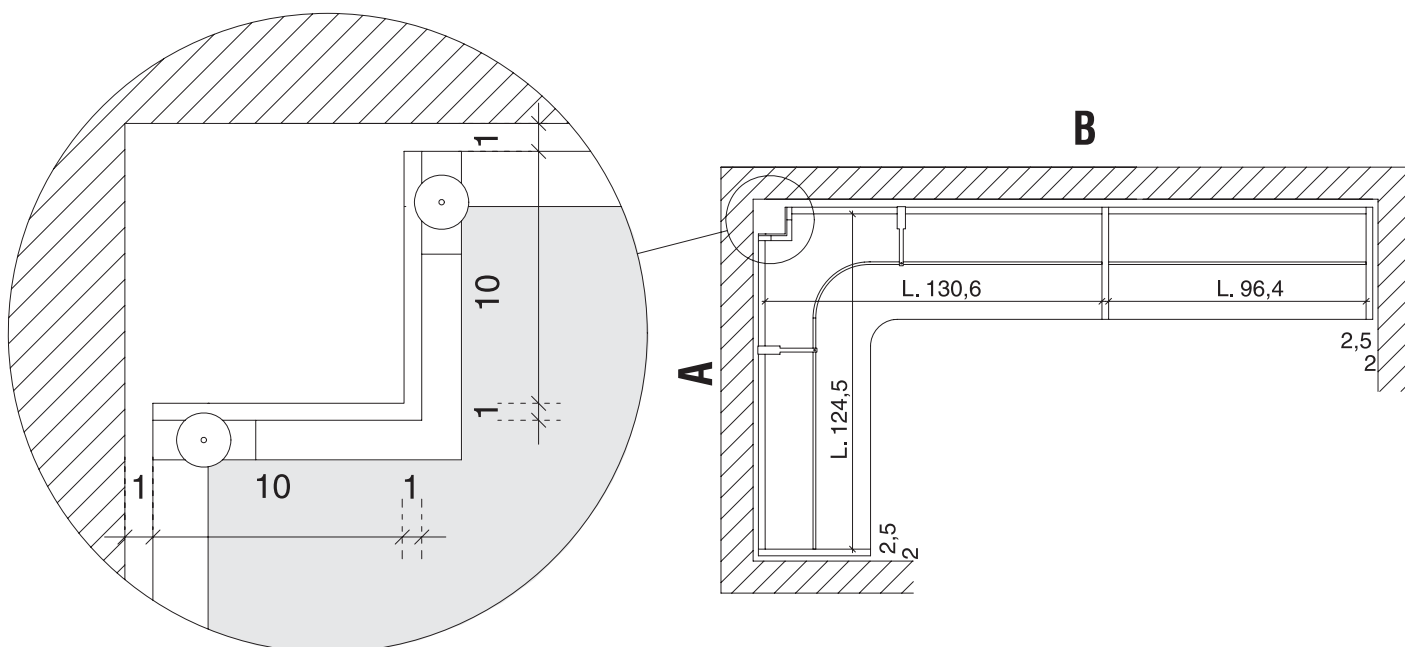



## TELAIO H. fino a 308 sp. 2,5 P. 56,2

con traverso strutturale  
fino a L. 98,9

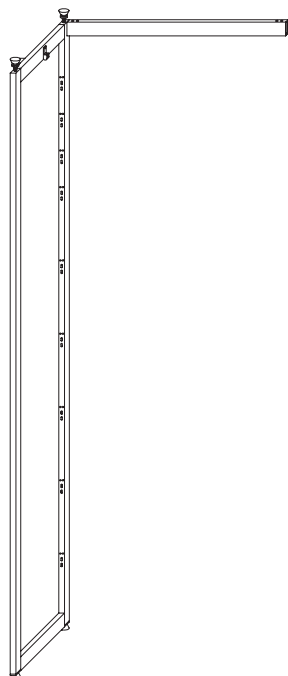

con traverso strutturale  
da L. 99 a L. 152,5

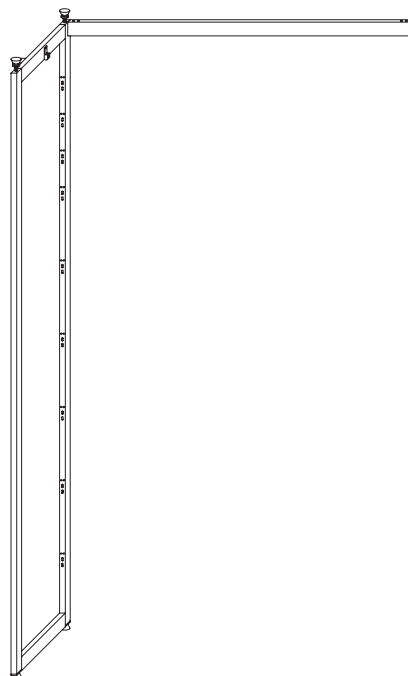

terminale



IC1	437	IC2	451	IC3	407
-----	-----	-----	-----	-----	-----

## RACCORDI L. 48,2 H. 2,5 sp. 2,5

Per il fissaggio del ripiano al telaio, forniti in numero necessario.



### In dotazione

## BASAMENTO sp. 2,5 P. 56 con traverso strutturale

fino a L. 96,4



da L. 96,5 a 150



IC4	92	IC5	123
-----	----	-----	-----

## BASAMENTO P. 56 con traverso strutturale con cassettera ad estrazione totale con BLUMOTION

fino a L. 96,4 H. 66,5

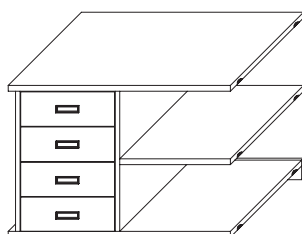

L. 41,4

fino a L. 96,4 H. 66,5

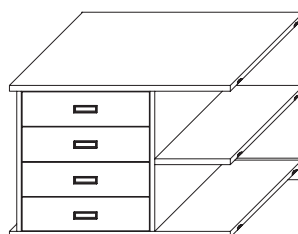

L. 56,4

L. 96,4 H. 66,5



L. 86,4

IC6	767	IC7	801	IC8	782
-----	-----	-----	-----	-----	-----

## BASAMENTO P. 56 con traverso strutturale con cassettera ad estrazione totale con BLUMOTION

da L. 96,5 a L. 150 H. 66,5

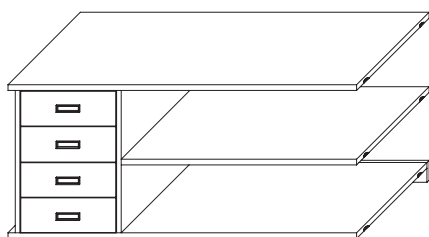

L. 41,4

da L. 96,5 a L. 150 H. 66,5

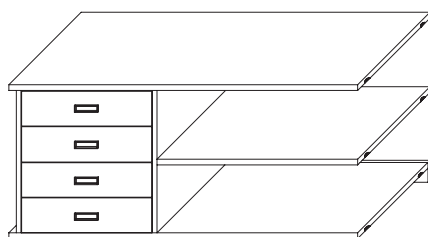

L. 56,4

da L. 96,5 a L. 150 H. 66,5

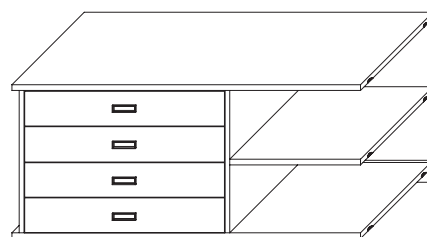

L. 86,4

<b>IC9</b>	<b>822</b>	<b>IC10</b>	<b>854</b>	<b>IC11</b>	<b>881</b>
------------	------------	-------------	------------	-------------	------------

da L. 96,5 a L. 150 H. 66,5

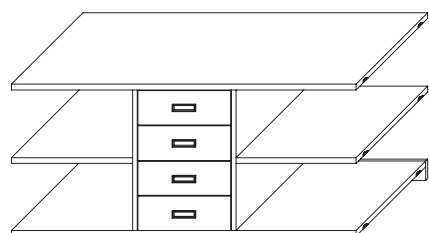

L. 41,4

da L. 96,5 a L. 150 H. 66,5

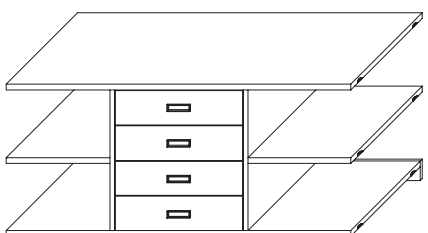

L. 56,4

<b>IC12</b>	<b>867</b>	<b>IC13</b>	<b>899</b>
-------------	------------	-------------	------------

## BASAMENTO P. 56 con traverso strutturale con serrandina e 3 ripiani in vetro

L. 96,4 H. 98,5

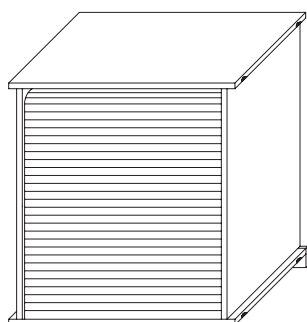

<b>IC14</b>	<b>805</b>
-------------	------------

**CANNE APPENDIABILI**

da fissare al traverso orizzontale superiore del telaio fino a L. 96,4



**IC15**    **21**

da fissare al traverso orizzontale superiore del telaio con gancio fino a L. 150

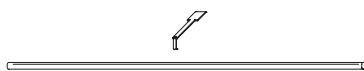

**IC16**    **54**

appendiabiti saliscendi fino a L. 96,4

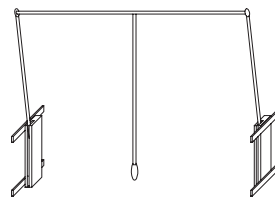

**IC17**    **326**

**RIPIANI sp. 2,5 P. 56**

fino a L. 96,4



**IC18**    **70**

con rinforzo posteriore da L. 96,5 a 150



**IC19**    **129**

portapantaloni ad estrazione totale con BLUMOTION L. 96,4

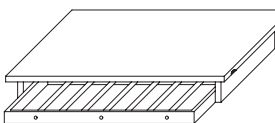

**IC20**    **310**

**RIPIANI sp. 2,5 P. 56 con canne appendiabiti**

fino a L. 96,4



**IC21**    **88**

con rinforzo posteriore da L. 96,5 a 150



**IC22**    **158**

## COLONNE H. fino a 308 P. 56,2

fino a L. 98,9

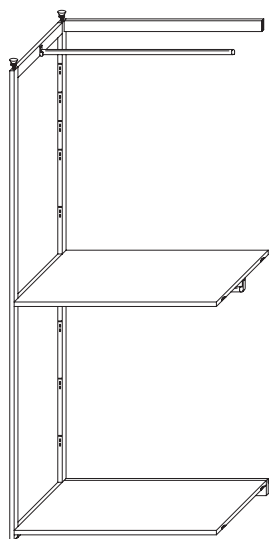

**IC23** 633

fino a L. 98,9

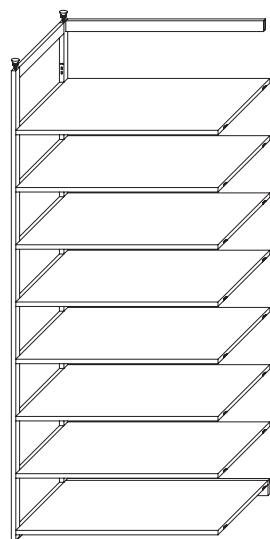

**IC24** 999

fino a L. 98,9

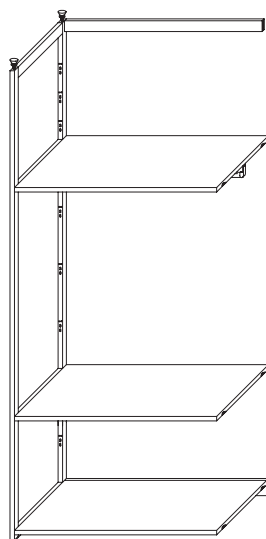

**IC25** 680

L. 98,9

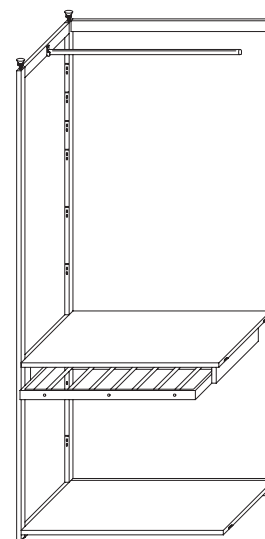

**IC26** 854

fino a L. 98,9

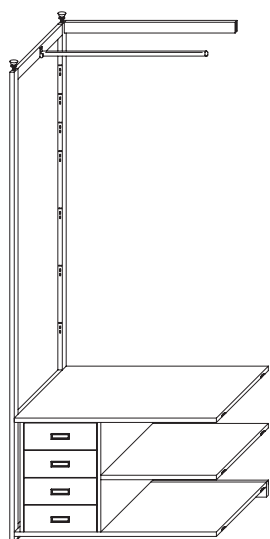

**IC27** 1.221

fino a L. 98,9

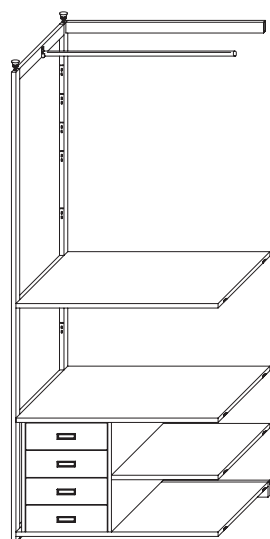

**IC28** 1.290

fino a L. 98,9

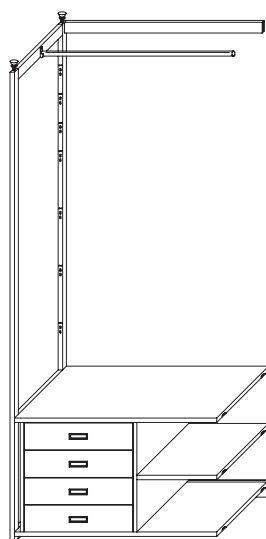

**IC29** 1.257

fino a L. 98,9

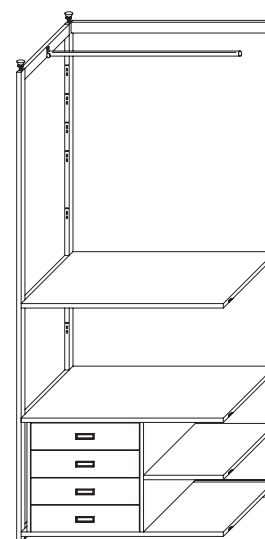

**IC30** 1.322

L. 98,9

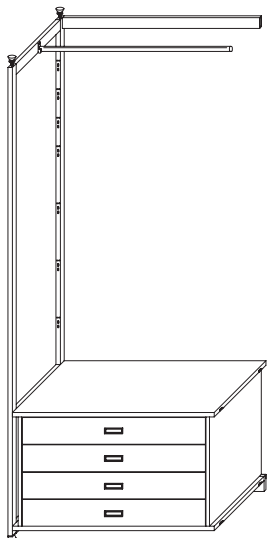

**IC31** 1.236

L. 98,9

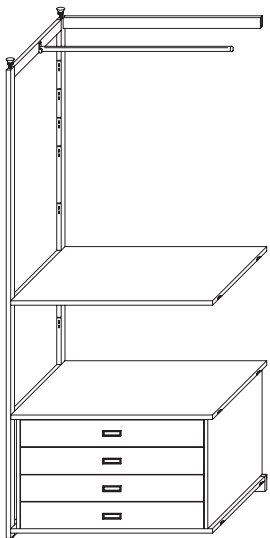

**IC32** 1.305

L. 98,9

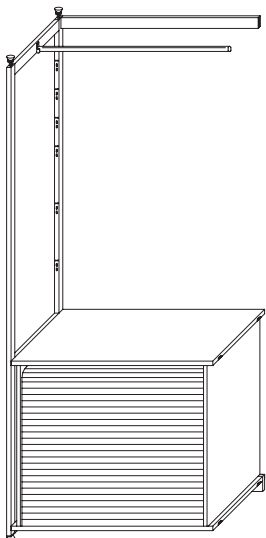

**IC33** 1.259

L. 2,5



**IC3** 407

## COLONNE H. fino a 308 P. 56,2

da L. 99 a 152,5

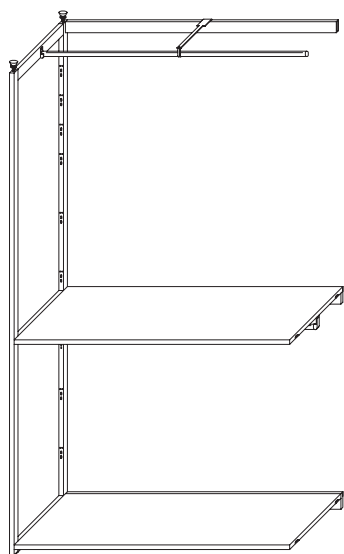

**IC34**

**781**

da L. 99 a 152,5

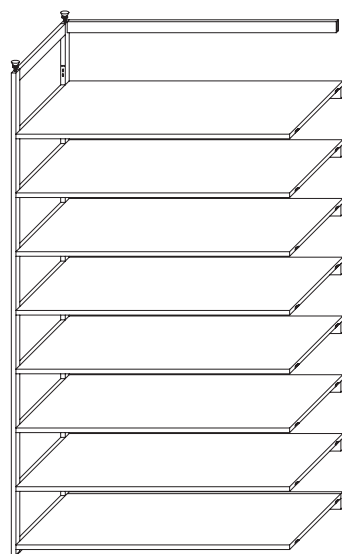

**IC35**

**1.465**

da L. 99 a 152,5

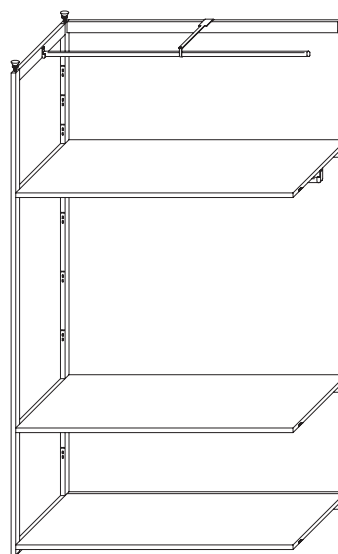

**IC36**

**909**

da L. 99 a 152,5

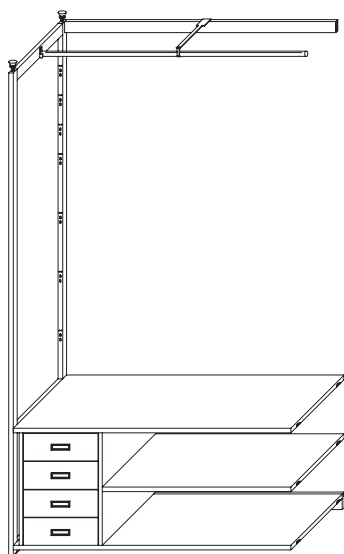

**IC37**

**1.322**

da L. 99 a 152,5

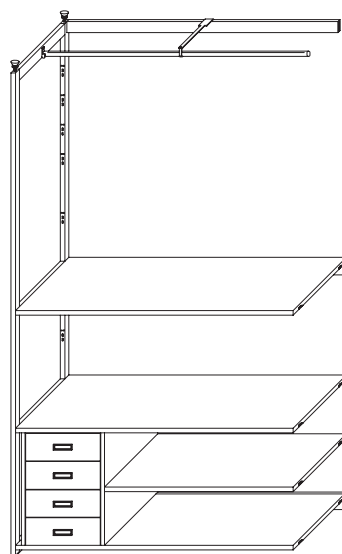

**IC38**

**1.450**

da L. 99 a 152,5

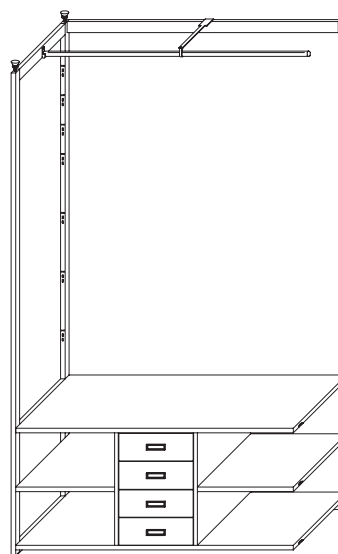

**IC39**

**1.368**

da L. 99 a 152,5

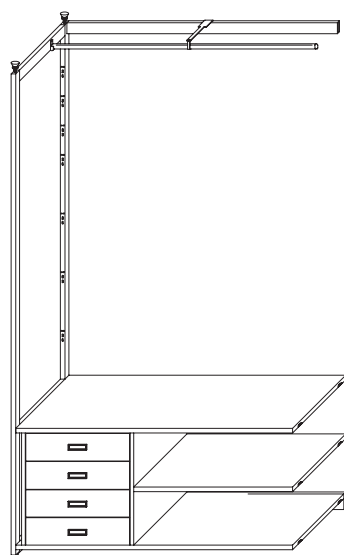

**IC40**

**1.322**

da L. 99 a 152,5

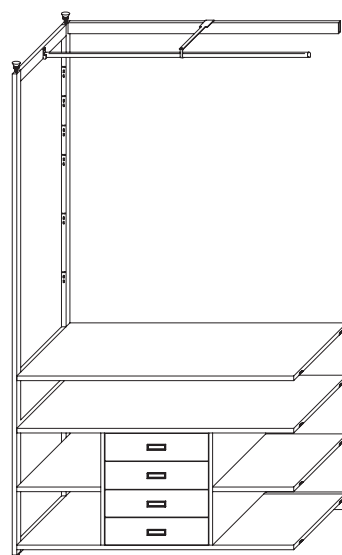

**IC41**

**1.450**

da L. 99 a 152,5

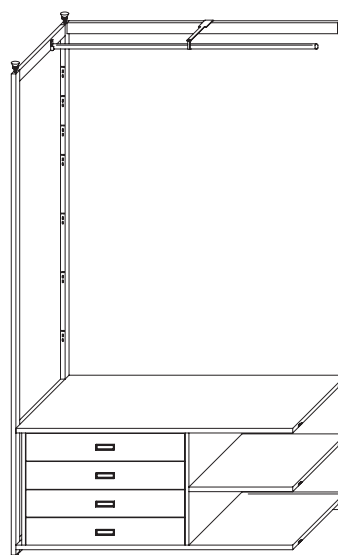

**IC42**

**1.368**

L. 2,5

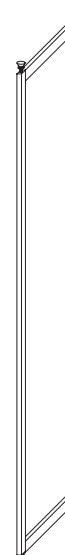

**IC3**

**407**

**TELAIO ANGOLARE H. fino a cm. 308**

con traverso strutturale  
fino a L. 142,5

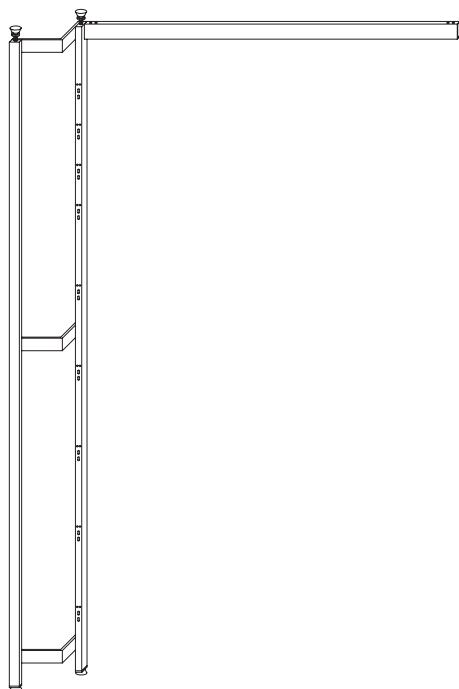

IC43	451
------	-----

**BASAMENTO ANGOLARE sp. 2,5 P. 56 con traversi strutturali**

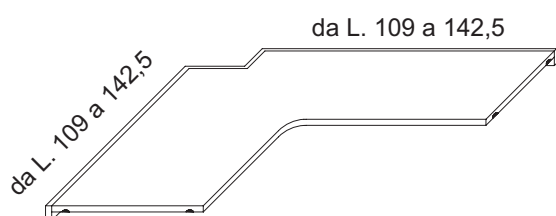

IC44	241
------	-----

**CANNA APPENDIABITI ANGOLARE**

da fissare ai traversi orizzontali  
superiori del telaio con ganci

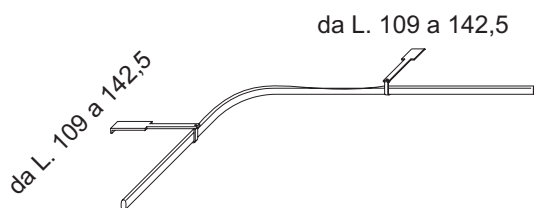

IC45	92
------	----

**RIPIANO ANGOLARE sp. 2,5 P. 56**

con rinforzi posteriori

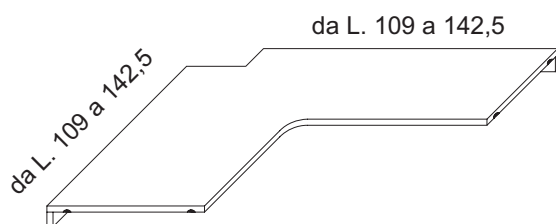

IC46	250
------	-----

con rinforzi posteriori  
e canna appendiabiti

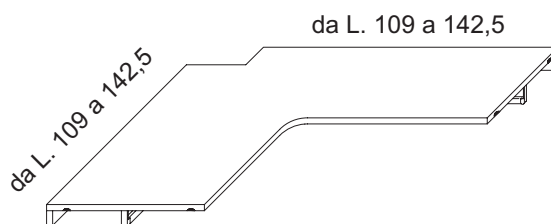

IC47	310
------	-----

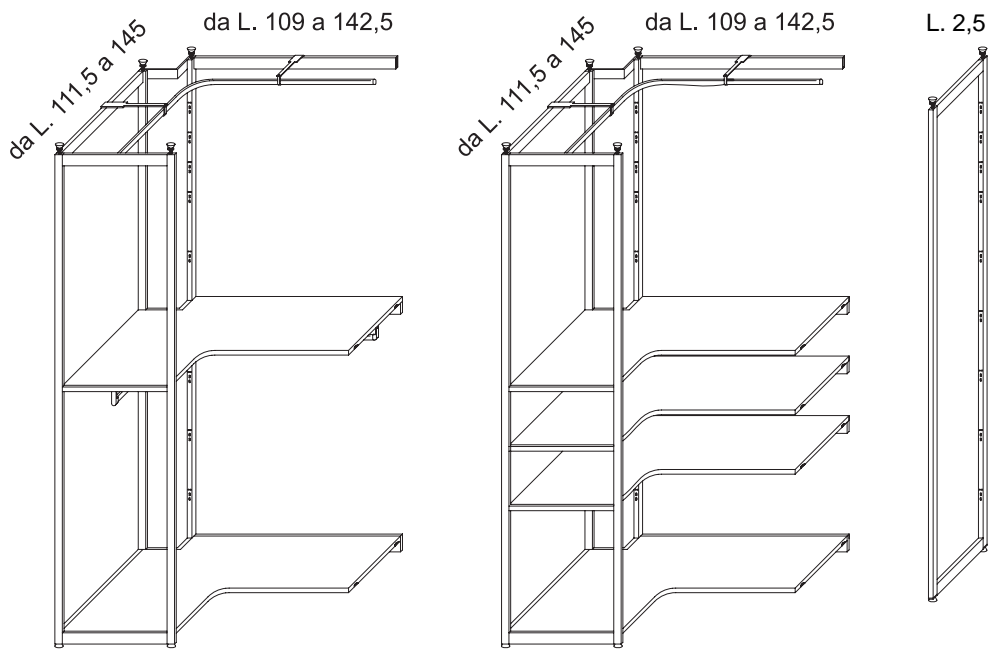
**COLONNE ANGOLARI H. fino a cm. 308**

<b>IC48</b>	<b>1.539</b>	<b>IC49</b>	<b>1.975</b>	<b>IC3</b>	<b>407</b>
-------------	--------------	-------------	--------------	------------	------------

## COMPOSIZIONI

Aggiungere cm. 2 per lato necessari per il montaggio.

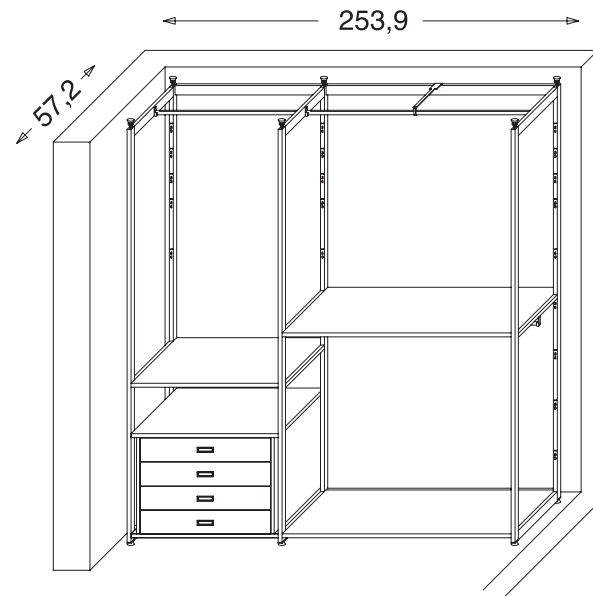
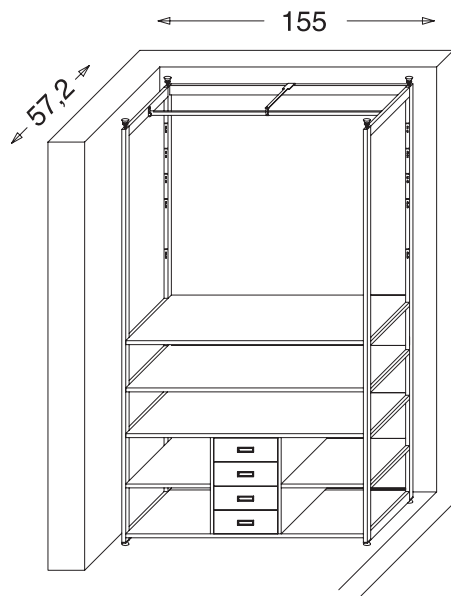

<b>IC50</b>	<b>2.029</b>	<b>IC51</b>	<b>2.490</b>
-------------	--------------	-------------	--------------

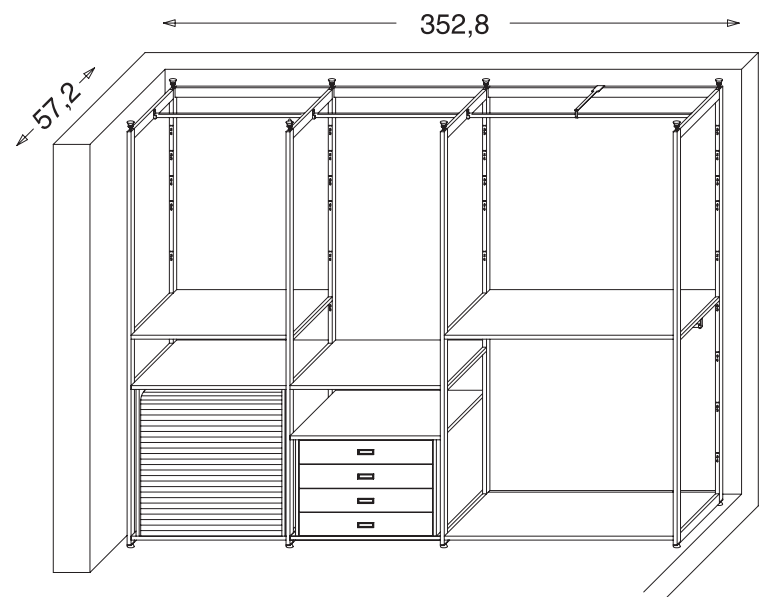
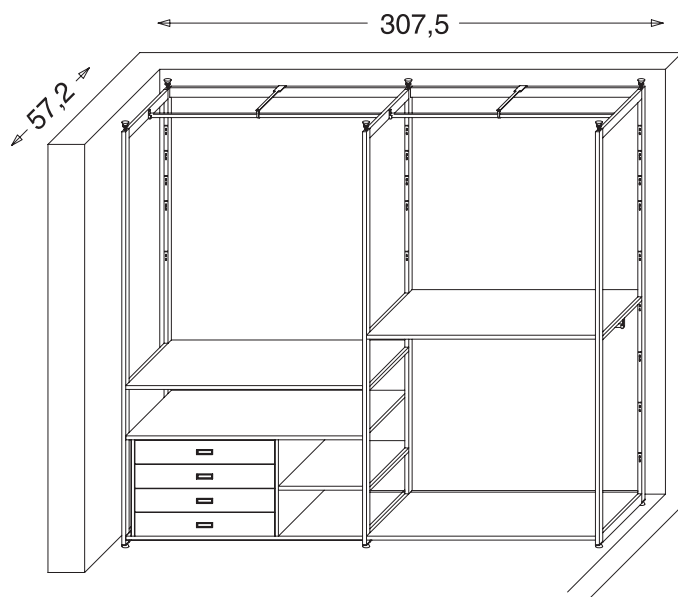

<b>IC52</b>	<b>2.695</b>	<b>IC53</b>	<b>3.813</b>
-------------	--------------	-------------	--------------

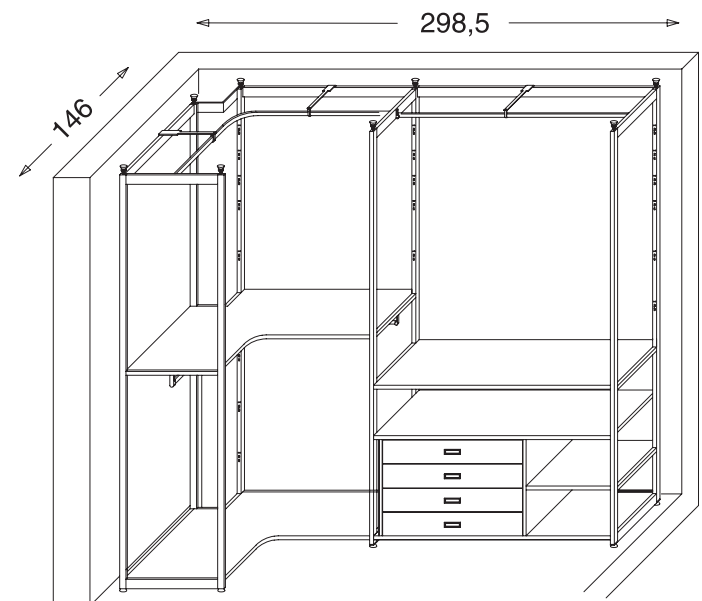
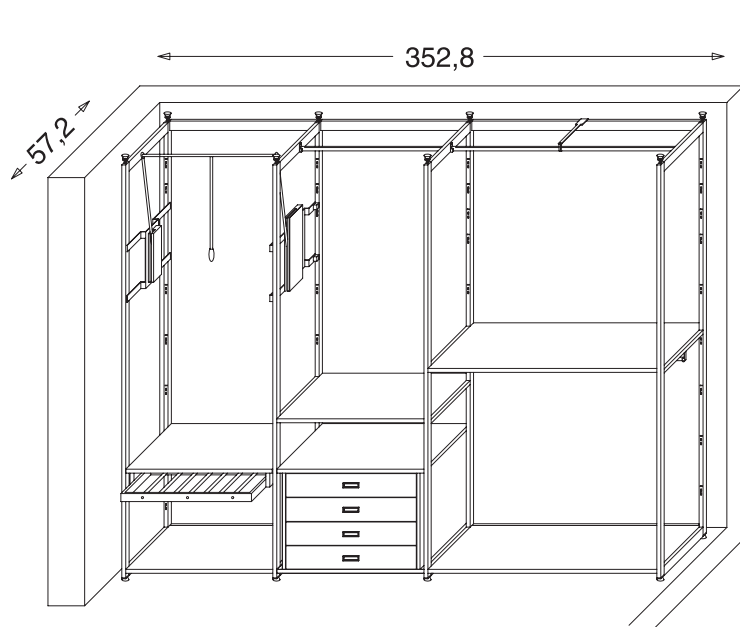

<b>IC54</b>	<b>3.946</b>	<b>IC55</b>	<b>3.451</b>
-------------	--------------	-------------	--------------





## ASCOT

La cabina armadio ASCOT è un sistema alternativo al solito armadio.

La cabina armadio ASCOT è costituita da fianchi e ripiani con cassettiere e canne appendiabiti.

I fianchi sono disponibili in varie altezze che consentono di creare composizioni tradizionali, da pavimento a soffitto, o più innovative con colonne sospese fissate a parete.

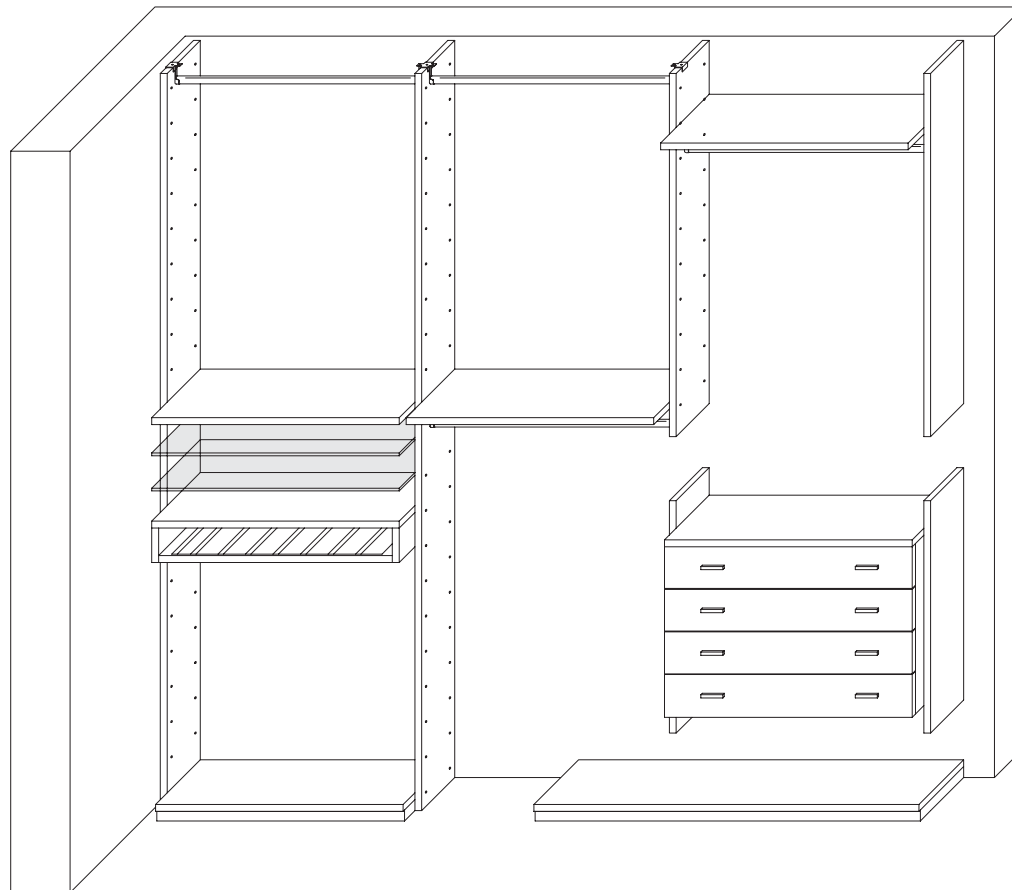

### FINITURE

- Nobilitato bianco
- Nobilitato grigio tessuto
- Nobilitato canapa tessuto
- Nobilitato larice bianco
- Nobilitato larice termo
- Nobilitato olmo urbano

A richiesta, la struttura e le attrezzature interne possono essere fornite in finitura laccato opaco scala RAL, NCS, al campione.

Contattare il Ns. Ufficio Tecnico per specifiche tecniche e preventivi.

**Tutte le attrezzature e i componenti in metallo sono verniciati color grigio alluminio.**

## COMPOSIZIONI LINEARI

Per garantire il montaggio dei fianchi, occorre considerare una tolleranza di cm. 7 in larghezza (cm. 3,5 per lato) e di cm. 2 in altezza.

### ISTRUZIONI PER CALCOLARE CORRETTAMENTE LE MISURE IN LARGHEZZA

ESEMPIO DI PARETE L. cm. 300

$$\text{cm. } 3,5 + 2,5 + 90 + 2,5 + 90 + 2,5 + 103 + 2,5 + 3,5 = 300$$

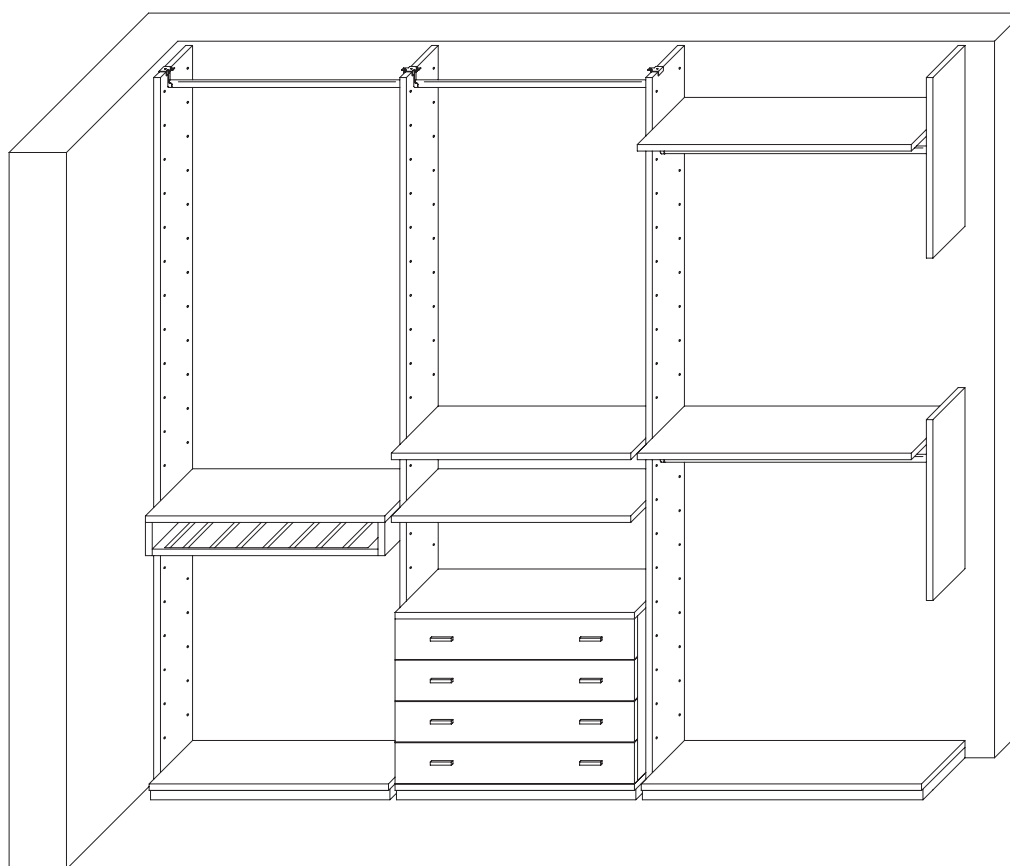
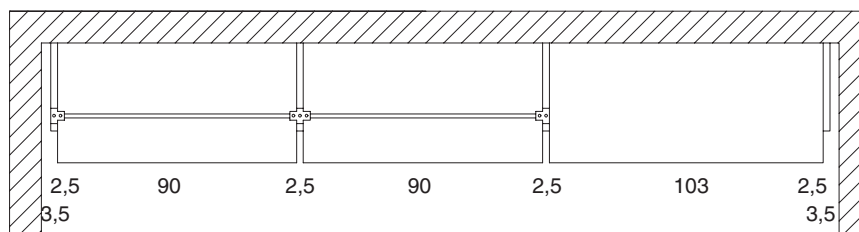

**COMPOSIZIONI ANGOLARI**

ISTRUZIONI PER CALCOLARE CORRETTAMENTE LE MISURE IN LARGHEZZA

ESEMPIO DI PARETE L. cm. 131 x 300

PARETE A: cm. 3,5 + 2,5 + 90 + 35 = cm. 131

PARETE B: cm. 35 + 74 + 2,5 + 90 + 2,5 + 90 + 2,5 + 3,5 = cm. 300

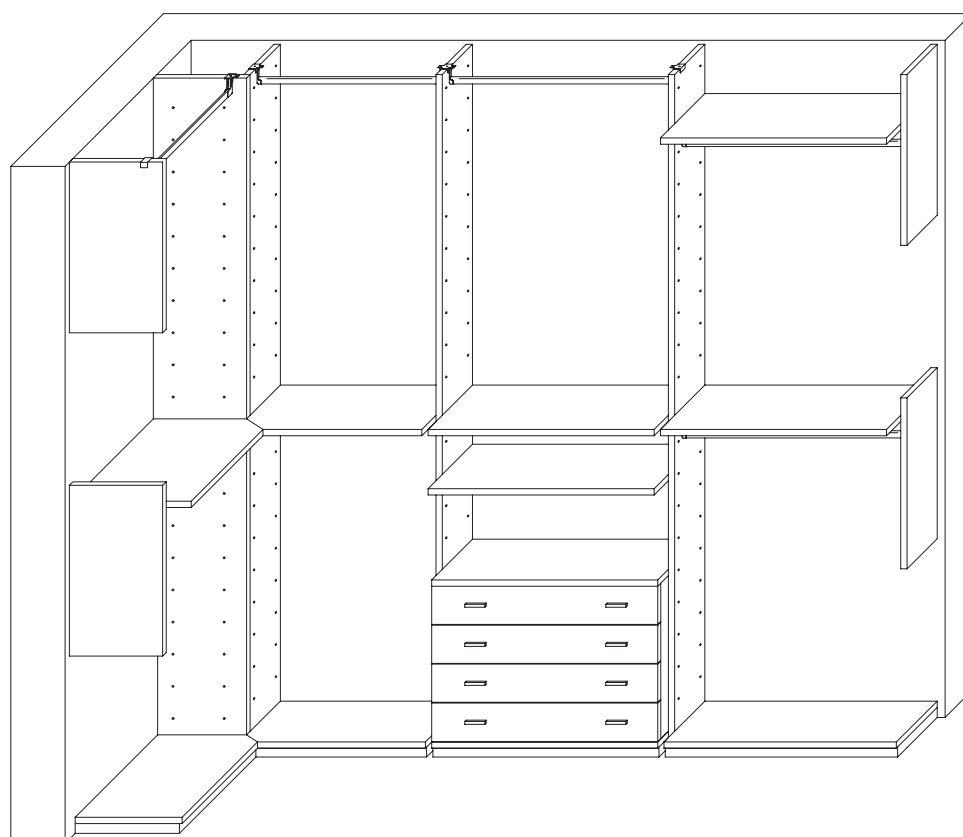
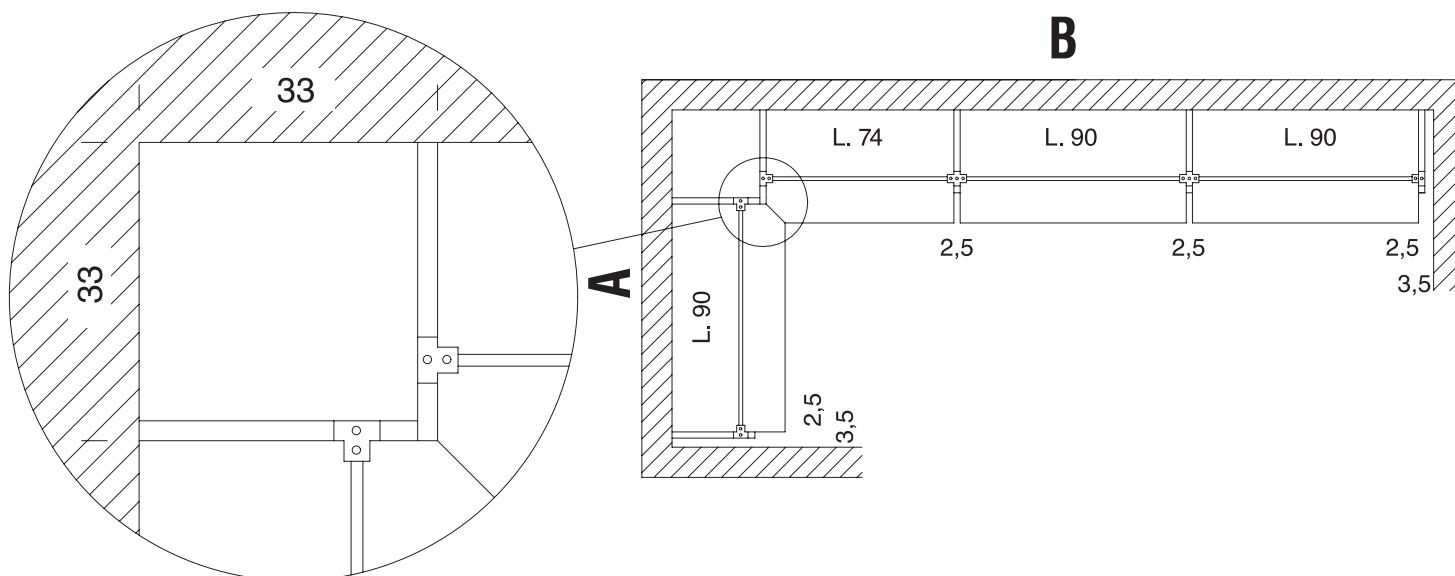

## COLONNA FLOOR

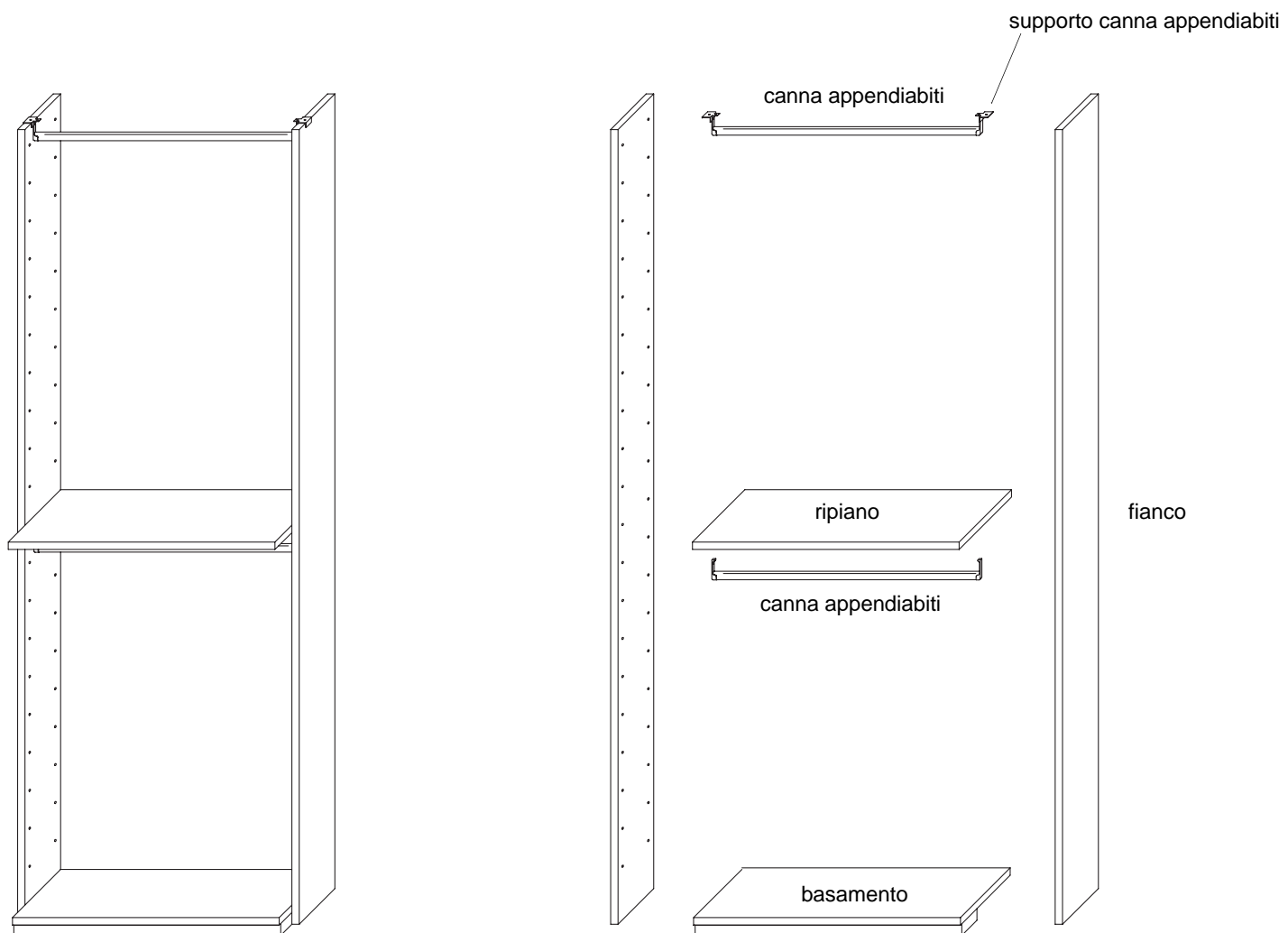

## COLONNA WALL

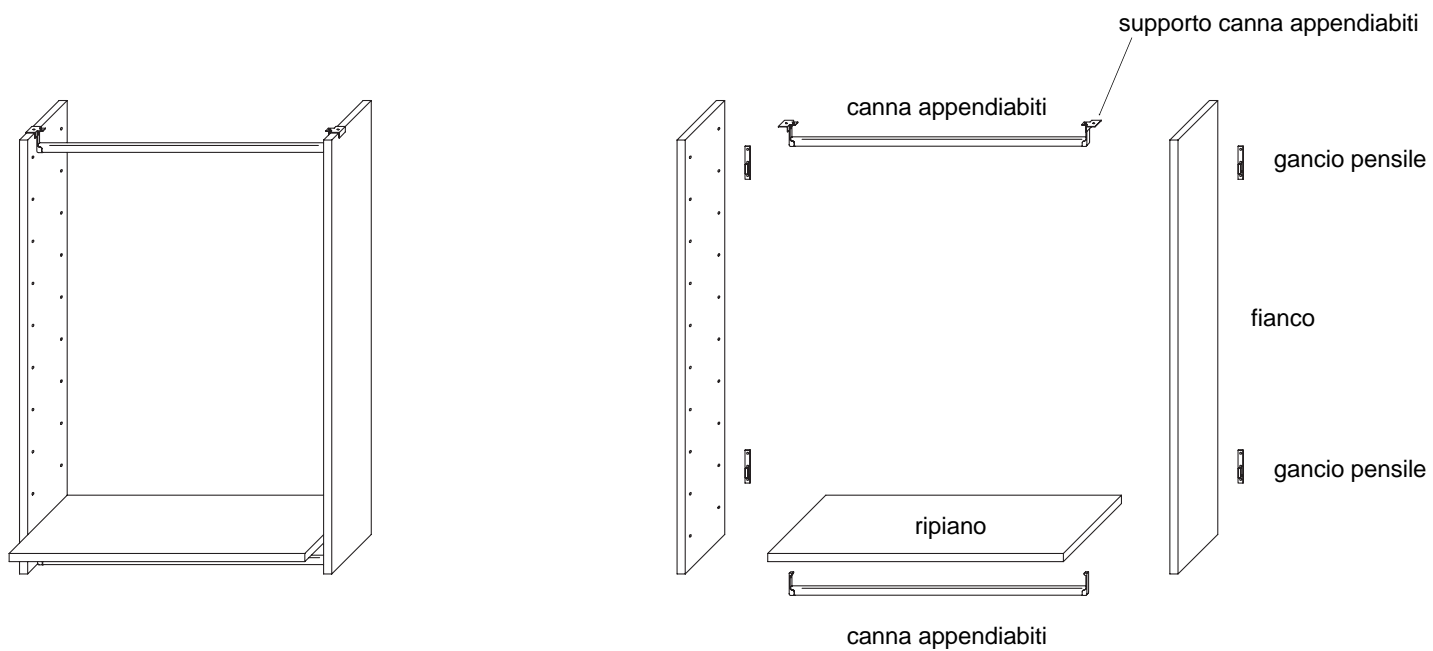

Le canne appendiabiti devono essere fissate sotto ai ripiani, ad eccezione di quando sono posizionate nella parte superiore della colonna, fissate ai supporti.

**SCHIENALI PER COLONNE FLOOR**

É possibile dotare le colonne FLOOR di schienali sp. cm. 1.

In tale situazione la profondità del fianco è di cm. 34,3 e la profondità della colonna è di cm. 46,3.

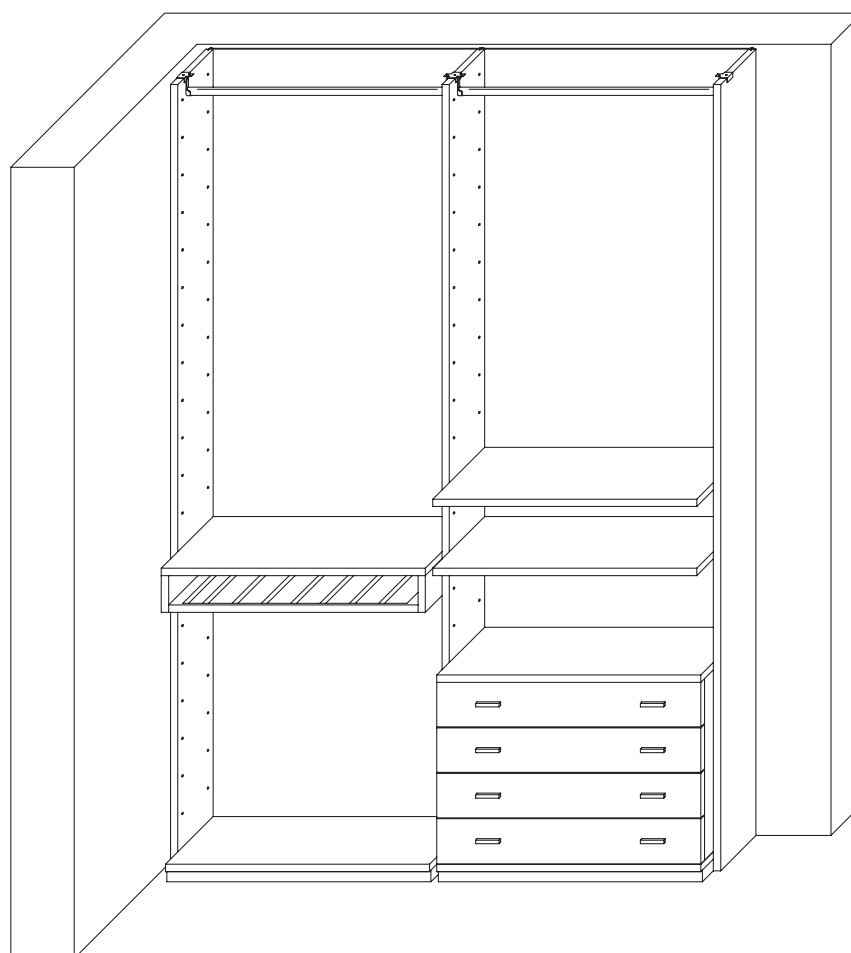
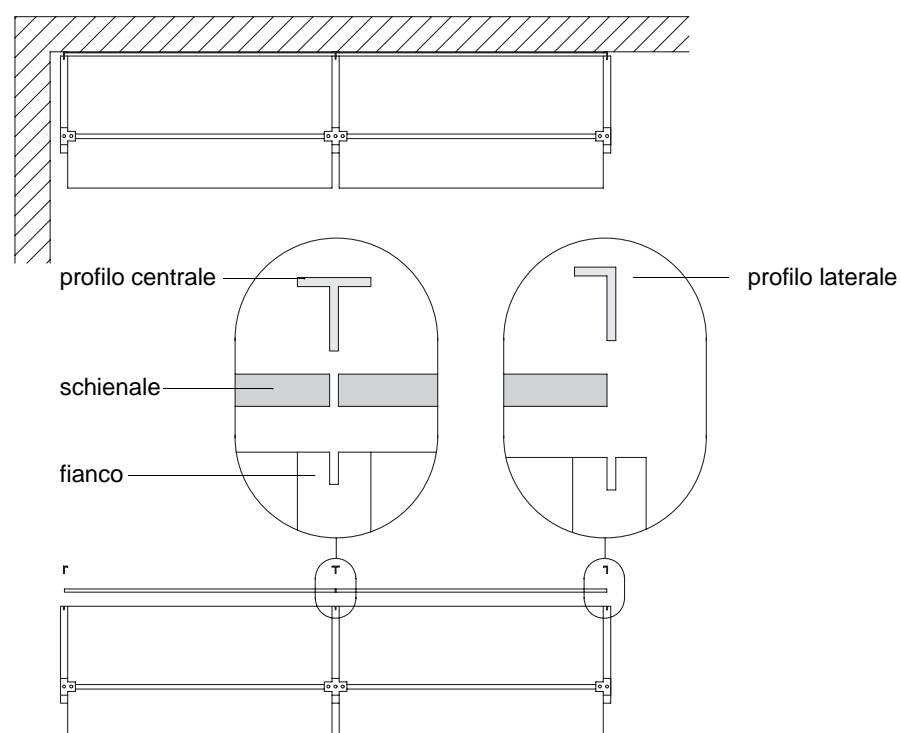

## FIANCO PER COLONNE FLOOR sp. 2,5 prof. 33 H. fino a 302,8

Nel caso di composizioni con colonne FLOOR e colonne WALL, la foratura del fianco FLOOR sarà adattata a quella del fianco WALL.

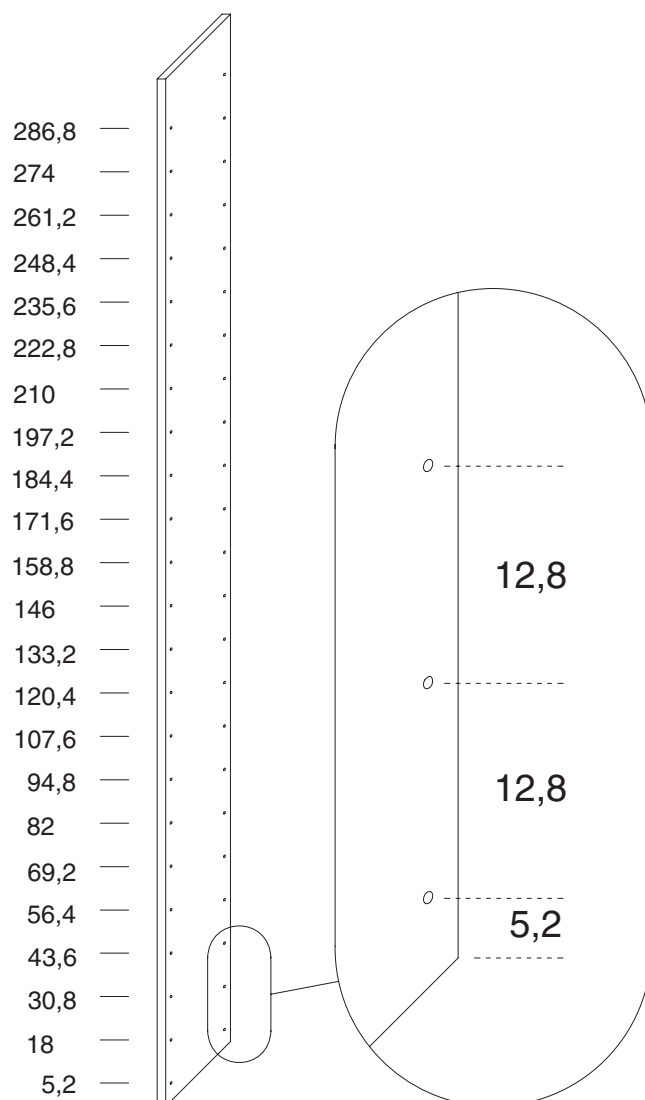

## RIPIANI sp. cm. 2,5

I ripiani sono sempre realizzati su misura.

### LARGHEZZA

fino a L. 90



### PROFONDITÀ

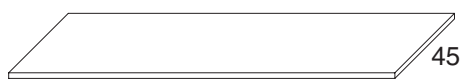

I ripiani sono disponibili anche con taglio a 45° per composizioni ad angolo.



**FIANCO PER COLONNE WALL CON 2 DUE GANCI PENSILI sp. 2,5 prof. 33 H. fino a 157,6**

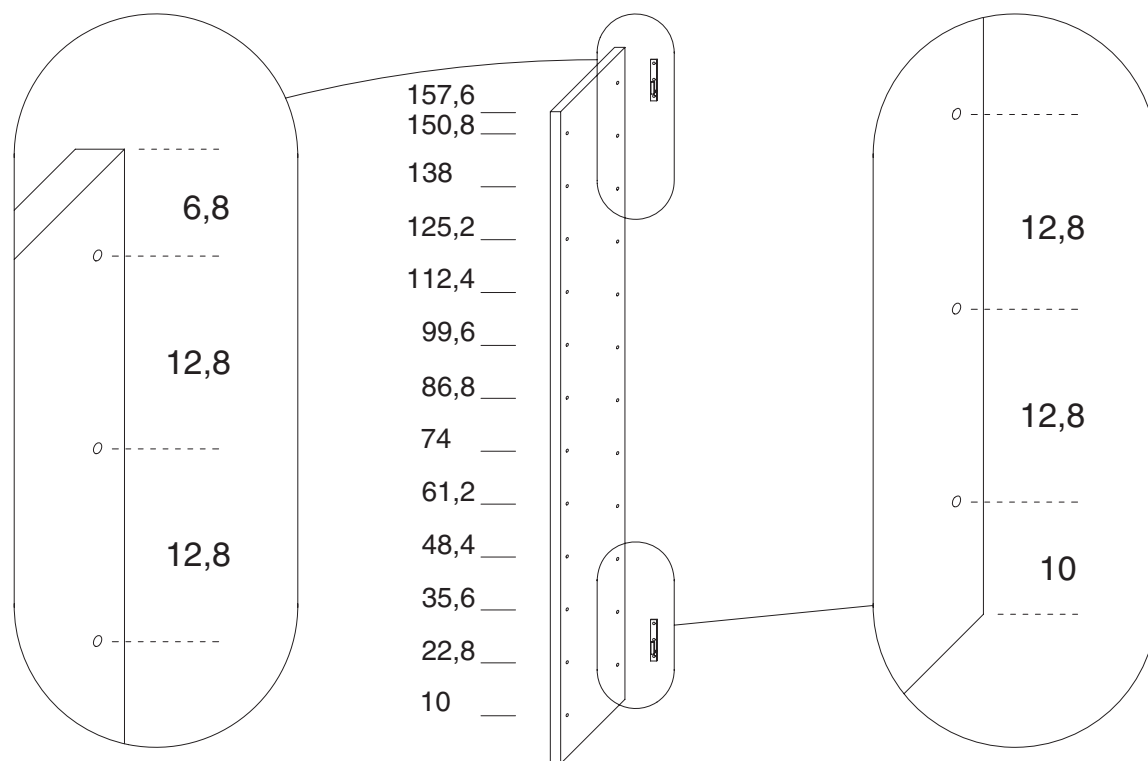

**RIPIANI sp. cm. 2,5**

I ripiani sono sempre realizzati su misura.

**LARGHEZZA**

fino a L. 90



**PROFONDITÀ**





**FIANCHI PER COLONNE WALL CON 2 GANCI PENSILI sp. 2,5 prof. 33**

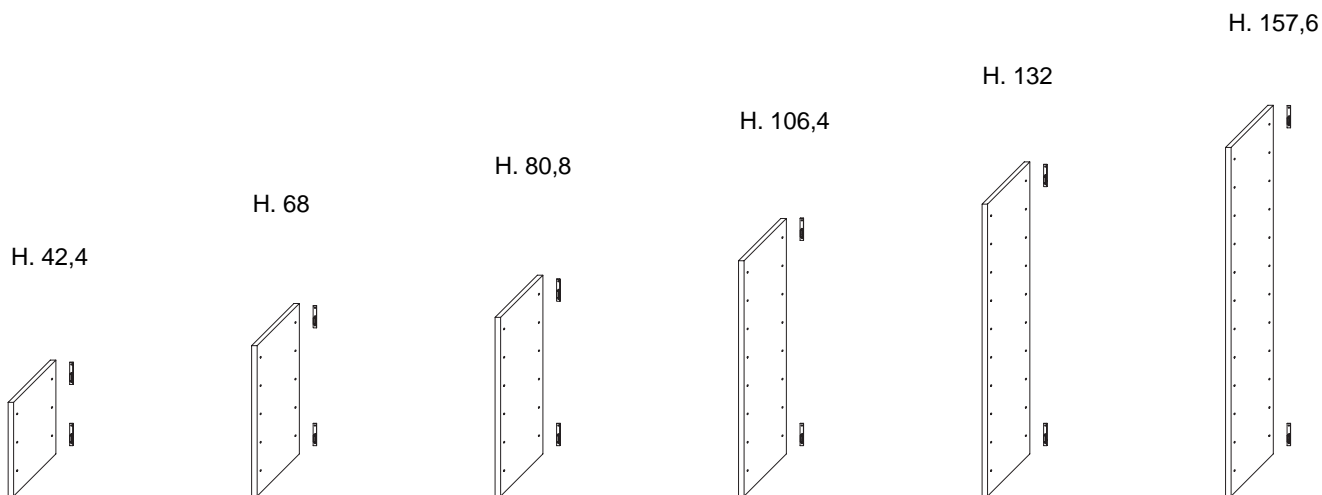

AS1	133	AS2	141	AS3	150	AS4	155	AS5	186	AS6	200
-----	-----	-----	-----	-----	-----	-----	-----	-----	-----	-----	-----

**FIANCHI PER COLONNE FLOOR sp. 2,5 prof. 33**

**FIANCHI PER COLONNE FLOOR ANGOLARI sp. 2,5 prof. 33**

fino a H. 270  
(H. soffitto)

da H. 270,1 a 302,8  
(H. soffitto)

fino a H. 270  
(H. soffitto)

da H. 270,1 a 302,8  
(H. soffitto)

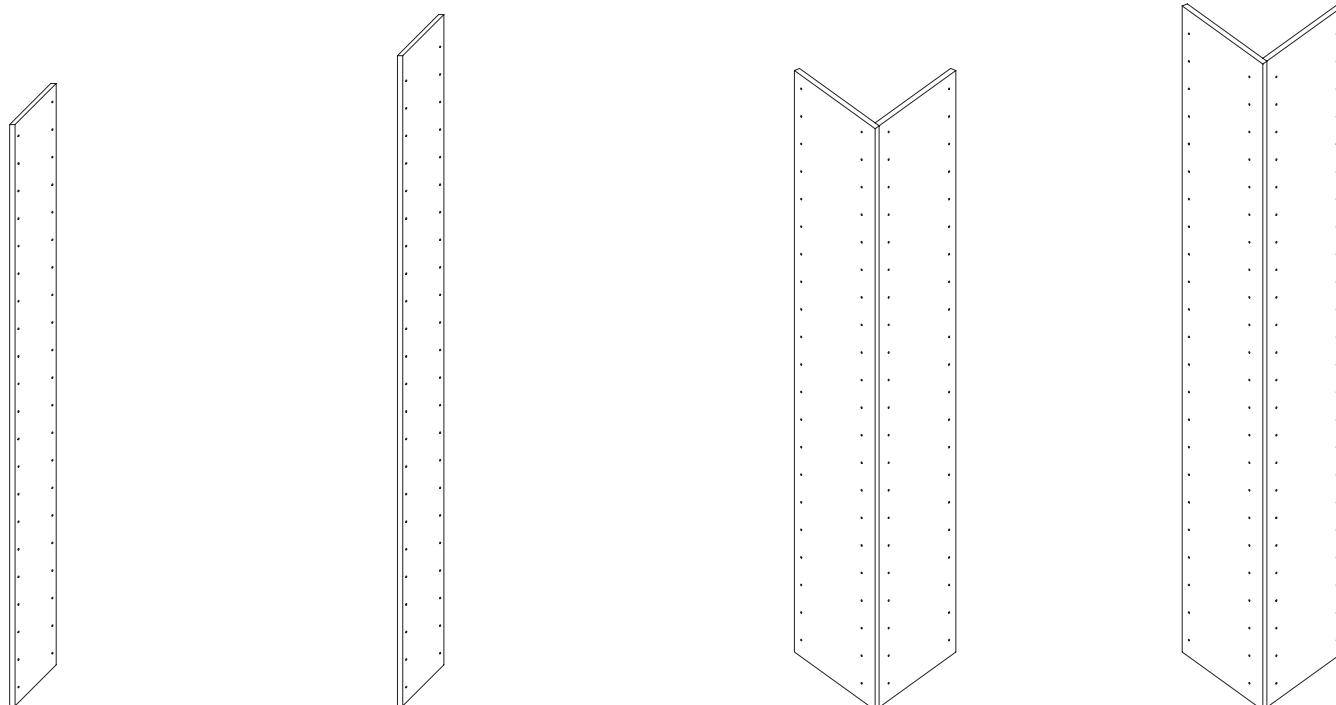

AS7	236	AS8	250	ASANG1	558	ASANG2	602
-----	-----	-----	-----	--------	-----	--------	-----

# ASCOT

SCHIENALI sp. cm. 1

ALTEZZA fino a cm. 270

fino a L. 45

da L. 45,1 a 60

da L. 60,1 a 90

Profilo per schienali



AS9	61	AS10	77	AS11	114	AS12	114
-----	----	------	----	------	-----	------	-----

ALTEZZA da cm. 270,1 a cm. 302,8

fino a L. 45

da L. 45,1 a 60

da L. 60,1 a 90

Profilo per schienali

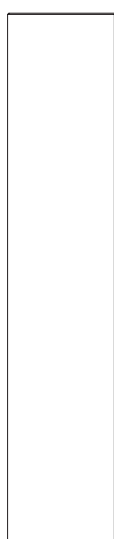

AS13	64	AS14	84	AS15	124	AS16	114
------	----	------	----	------	-----	------	-----

[TORNA ALL'INDICE](#)

# ASCOT

## BASAMENTI sp. 2,5 prof. 45 con zoccolo in alluminio H. 4

fino a L. 45

da L. 45,1 a 60

da L. 60,1 a 90

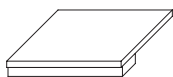

<b>AS17</b>	<b>97</b>		<b>AS18</b>	<b>106</b>		<b>AS19</b>	<b>123</b>	
<b>ASANG3</b>	<b>133</b>	Taglio 45°	<b>ASANG4</b>	<b>145</b>	Taglio 45°	<b>ASANG5</b>	<b>158</b>	Taglio 45°

## CANNE APPENDIABILI

fino a L. 45

da L. 45,1 a 60

da L. 60,1 a 90



<b>AS20</b>	<b>19</b>		<b>AS21</b>	<b>20</b>		<b>AS22</b>	<b>21</b>
-------------	-----------	--	-------------	-----------	--	-------------	-----------

## APPENDIABILI SALISCENDI - Portata max. kg. 10

fino a L. 45

da L. 45,1 a 60

da L. 60,1 a 90

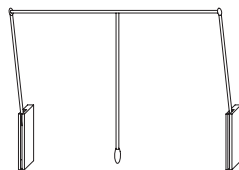
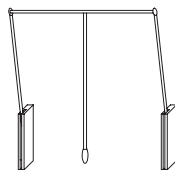
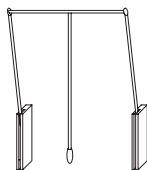

<b>AS23</b>	<b>272</b>		<b>AS24</b>	<b>272</b>		<b>AS25</b>	<b>272</b>
-------------	------------	--	-------------	------------	--	-------------	------------

## RIPIANI sp. 2,5 prof. 45

fino a L. 45

da L. 45,1 a 60

da L. 60,1 a 90

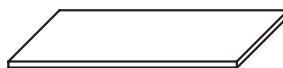
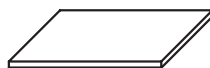

<b>AS26</b>	<b>77</b>		<b>AS27</b>	<b>84</b>		<b>AS28</b>	<b>92</b>	
<b>ASANG6</b>	<b>114</b>	Taglio 45°	<b>ASANG7</b>	<b>123</b>	Taglio 45°	<b>ASANG8</b>	<b>129</b>	Taglio 45°

## RIPIANI sp. 2,5 prof. 45 con canna appendiabiti

fino a L. 45

da L. 45,1 a 60

da L. 60,1 a 90

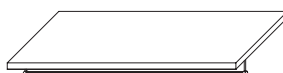
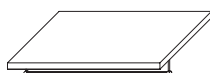
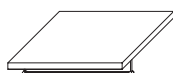

<b>AS29</b>	<b>94</b>		<b>AS30</b>	<b>102</b>		<b>AS31</b>	<b>110</b>	
<b>ASANG9</b>	<b>130</b>	Taglio 45°	<b>ASANG10</b>	<b>140</b>	Taglio 45°	<b>ASANG11</b>	<b>150</b>	Taglio 45°

Portapantaloni  
ad estrazione totale  
con BLUMOTION  
L. 90 P. 45 H. 11,5

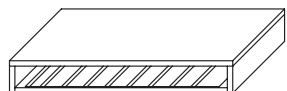

Portacamicie  
con schienale  
e 2 ripiani interni in vetro  
L. 90 P. 45 H. 40,9

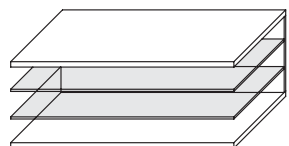

Portacamicie con schienale  
e 2 ripiani interni in vetro e  
portapantaloni ad estrazione  
totale con BLUMOTION  
L. 90 P. 45 H. 49,9

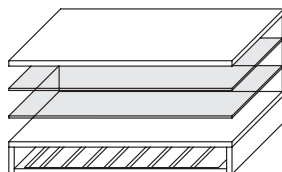

AS32	304	AS33	466	AS34	679
------	-----	------	-----	------	-----

## CASSETTIERE ad estrazione totale con BLUMOTION H. 34,2 P. 45

L. 45



L. 60



L. 90

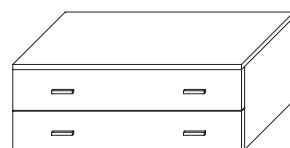

AS35	415	AS36	449	AS37	485
------	-----	------	-----	------	-----

## CASSETTIERE ad estrazione totale con BLUMOTION H. 64,8 P. 45

L. 45



L. 60



L. 90



AS38	617	AS39	667	AS40	718
------	-----	------	-----	------	-----

## CASSETTIERE ad estrazione totale con BLUMOTION H. 95,4 P. 45

L. 45

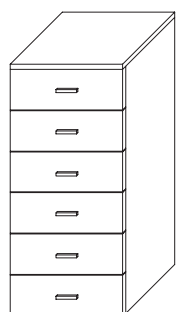

L. 60

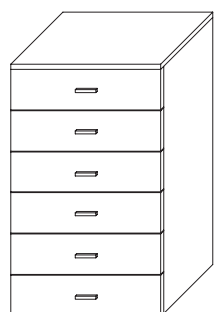

L. 90

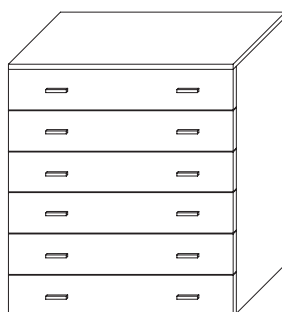

AS41	874	AS42	942	AS43	1.006
------	-----	------	-----	------	-------

# ASCOT

## CONTENITORI L. 90 H. 94.6 P. 45

Serrandina  
con 3 ripiani in vetro

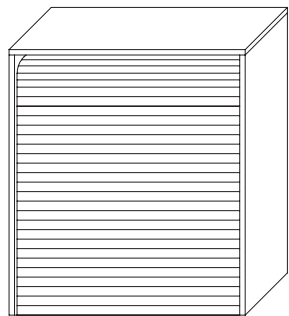

Alveare

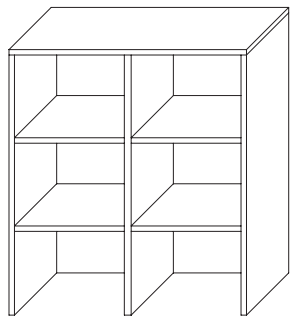

AS44	729	AS45	277
------	-----	------	-----

## CASSETTIERE SU RUOTE ad estrazione totale con BLUMOTION H. 42,1 P. 45

L. 45

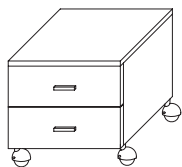

L. 60

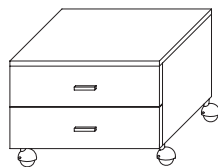

L. 90



AS46	437	AS47	471	AS48	508
------	-----	------	-----	------	-----

## CASSETTIERE SU RUOTE ad estrazione totale con BLUMOTION H. 72,7 P. 45

L. 45



L. 60

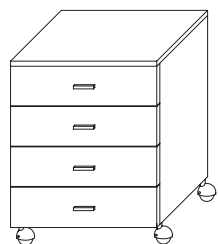

L. 90

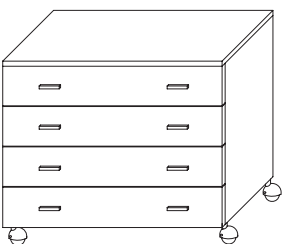

AS49	640	AS50	691	AS51	739
------	-----	------	-----	------	-----

## CASSETTIERE SU RUOTE ad estrazione totale con BLUMOTION H. 103,3 P. 45

L. 45

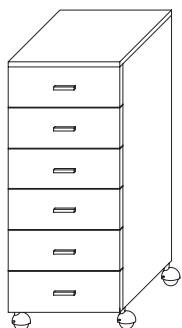

L. 60

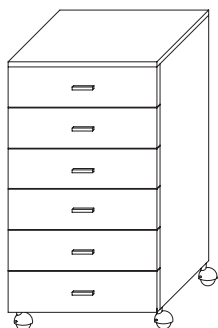

L. 90



AS52	898	AS53	963	AS54	1.030
------	-----	------	-----	------	-------

## ELEMENTI SU RUOTE

Cesto portabiancheria  
in filo di ferro  
L. 45 H. 57,5 P. 43

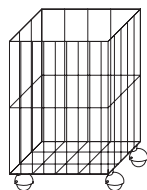

Ripiano portascatole  
L. 90 H. 18,5 P. 45

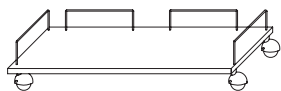

Contenitore in lamiera  
L. 90 H. 34,7 P. 45

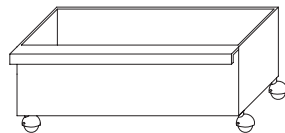

AS55	94	AS56	138	AS57	317
------	----	------	-----	------	-----

## ELEMENTI SU RUOTE

serrandina con 3  
ripiani in vetro  
L. 90 H. 103,3 P. 45

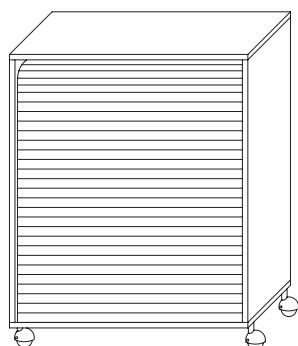

alveare  
L. 90 H. 103,3 P. 45

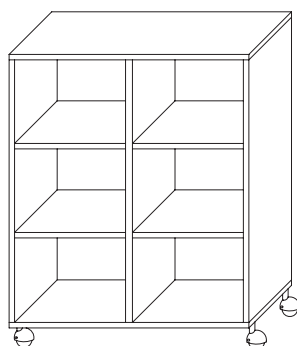

AS58	841	AS59	390
------	-----	------	-----

## ATTREZZATURE da fissare a parete con viti

Mensola  
sp. 2,5 p. 33  
al metro lineare

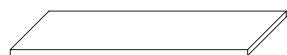

Coppia  
reggimensola  
color grigio



Pomolo  
appendiabiti



Svuotatasche  
L. 30 H. 15 P. 10

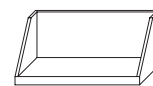

AS60	84	AS61	21	AS62	17	AS63	51
------	----	------	----	------	----	------	----

Staffa appendiabiti  
L. 28

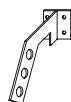

Portacravatte  
L. 50 H. 9



Portacinture  
L. 50 H. 9



Portagonne  
portapantaloni  
L. 50 - H. 9 - P. 20

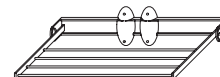

AS64	76	AS65	81	AS66	140	AS67	148
------	----	------	----	------	-----	------	-----

## ATTREZZATURE da fissare a parete con viti

Portascarpe estensibile  
in filo di ferro  
L. 67/115 P.20

Vaschetta per  
portascarpe estensibile  
(facoltativo)

Portascarpe  
L. 48 H. 70 P. 22

Specchio  
L. 36 H. 160

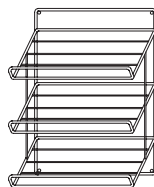
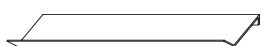

AS68	47	AS69	70	AS70	84	AS71	94
------	----	------	----	------	----	------	----

## PANCHE sp. 2,5 prof. 45 CON ZOCCOLO IN ALLUMINIO H. 4

fino a L. 100

da L. 100,1 a 150

da L. 150,1 a 200



AS72	167	AS73	221	AS74	265
------	-----	------	-----	------	-----

da L. 200,1 a 250

da L. 250,1 a 300

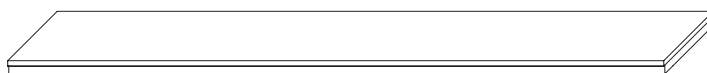
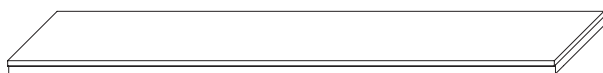

AS75	332	AS76	376
------	-----	------	-----

## COLONNE H. 270 (soffitto) P. 45

fino a L. 47,5

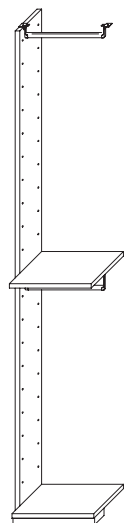

fino a L. 47,5

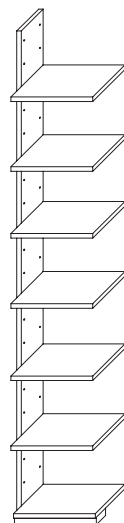

fino a L. 47,5

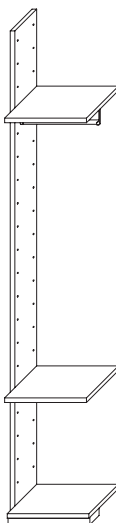

<b>AS77</b>	<b>437</b>	<b>AS78</b>	<b>779</b>	<b>AS79</b>	<b>494</b>
-------------	------------	-------------	------------	-------------	------------

L. 47,5

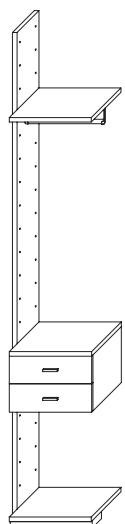

L. 47,5

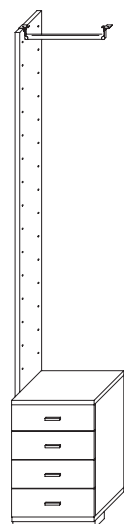

L. 47,5

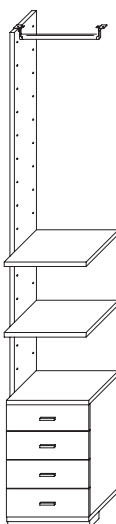

<b>AS80</b>	<b>831</b>	<b>AS81</b>	<b>960</b>	<b>AS82</b>	<b>1.109</b>
-------------	------------	-------------	------------	-------------	--------------

da L. 47,6 a 62,5

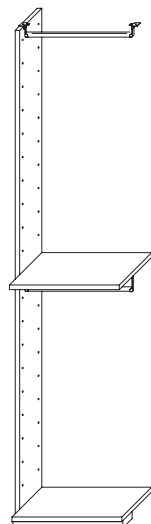

da L. 47,6 a 62,5

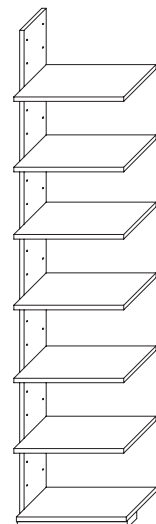

da L. 47,6 a 62,5

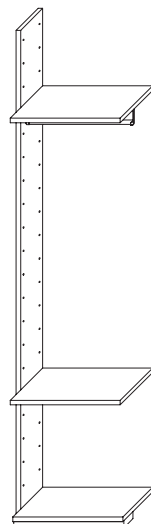

sp. 2,5



<b>AS83</b>	<b>458</b>	<b>AS84</b>	<b>834</b>	<b>AS85</b>	<b>521</b>	<b>AS7</b>	<b>236</b>
-------------	------------	-------------	------------	-------------	------------	------------	------------



# ASCOT

## COLONNE H. 270 (soffitto) P. 45

L. 62,5

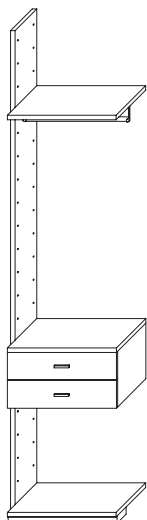

L. 62,5

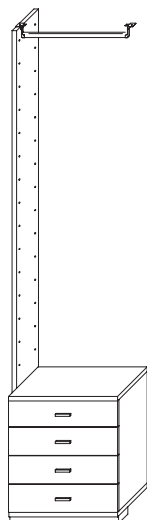

L. 62,5

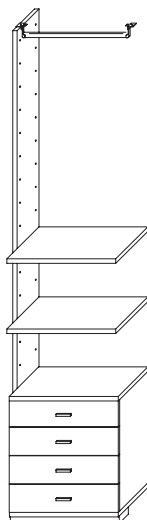

**AS86**    **886**

**AS87**    **1.023**

**AS88**    **1.187**

da L. 62,6 a 92,5

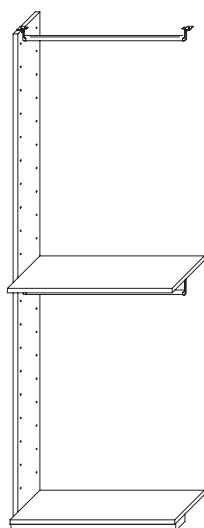

da L. 62,6 a 92,5

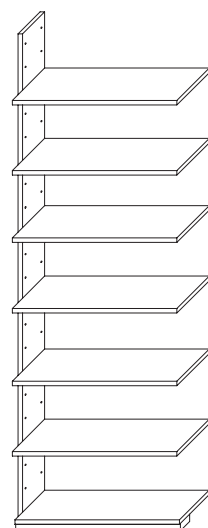

da L. 62,6 a 92,5

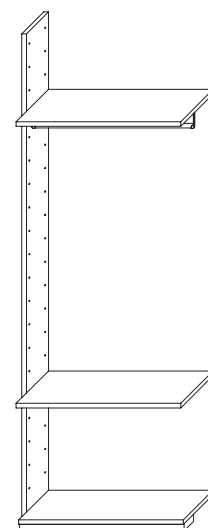

L. 92,5

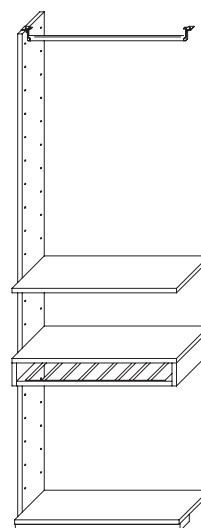

**AS89**    **484**

**AS90**    **896**

**AS91**    **555**

**AS92**    **766**

L. 92,5

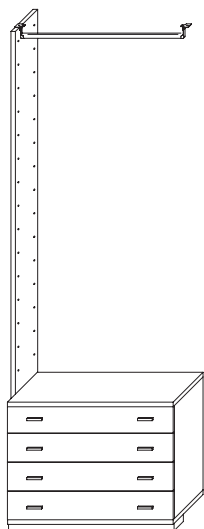

L. 92,5

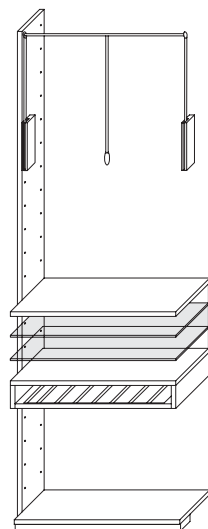

L. 92,5

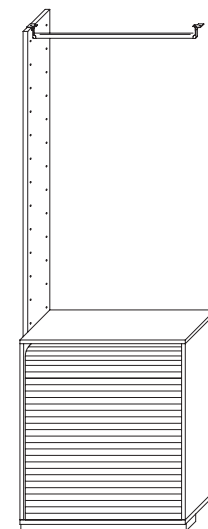

sp. 2,5



**AS93**    **1.088**

**AS94**    **1.303**

**AS95**    **1.101**

**AS7**    **236**

## COMPOSIZIONI

Aggiungere cm. 3,5 per lato necessari per il montaggio.

I prezzi si intendono riferiti a composizioni con fianchi H. cm. 270 (H. soffitto).

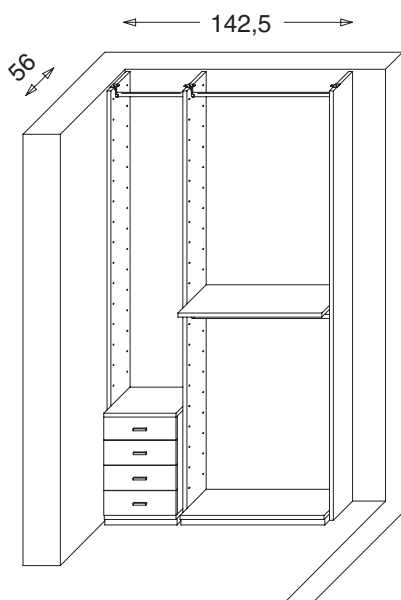

**AS96** 1.673

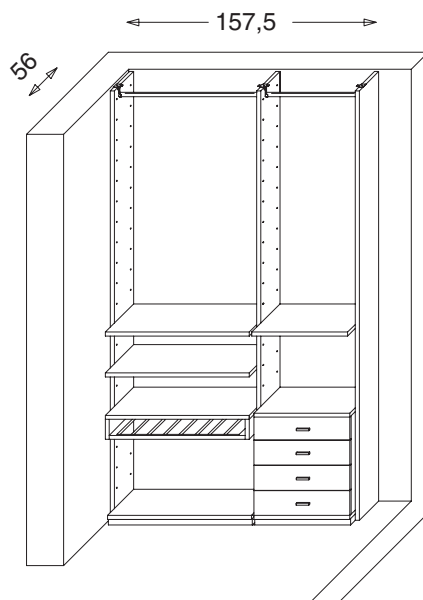

**AS97** 2.192

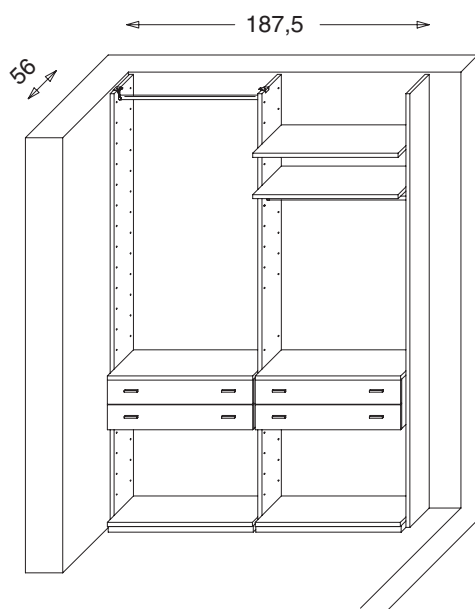

**AS98** 2.125

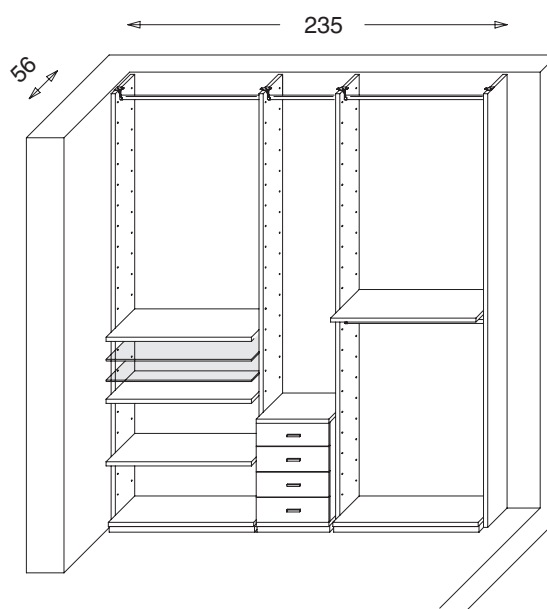

**AS99** 2.600

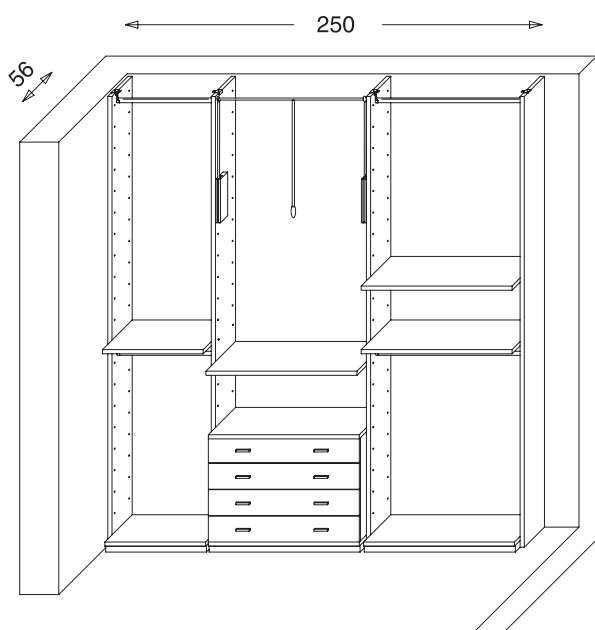

**AS100** 2.690

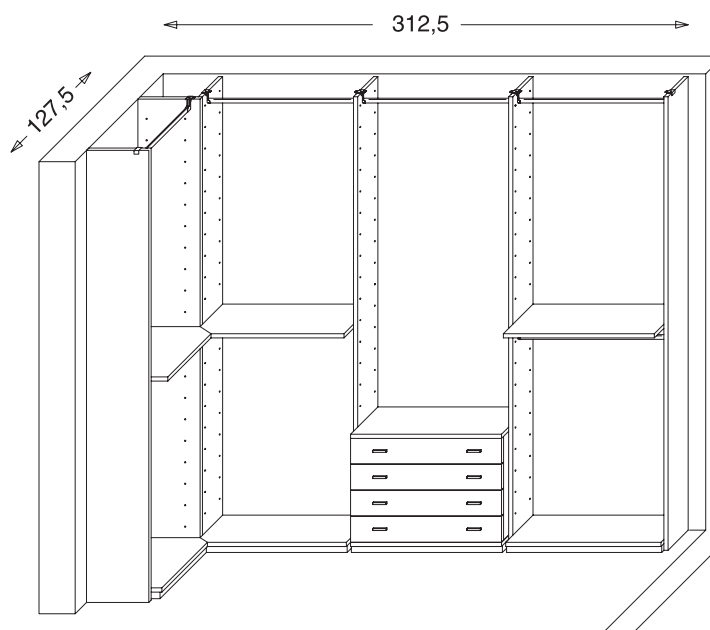

**AS101** 3.237

## Vista assonometrica

## Schema quotato

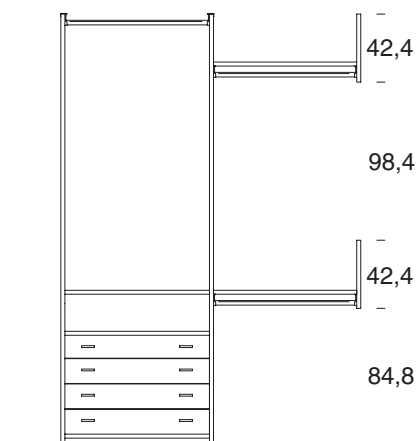
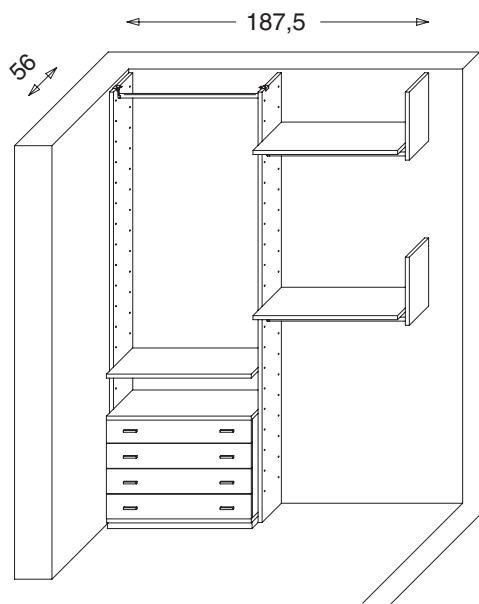

AS102 1.894

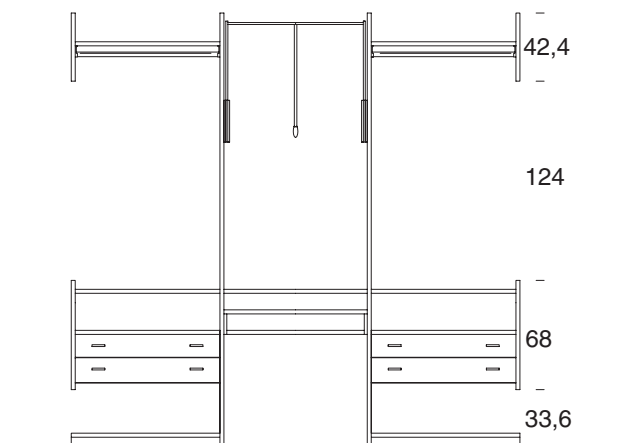
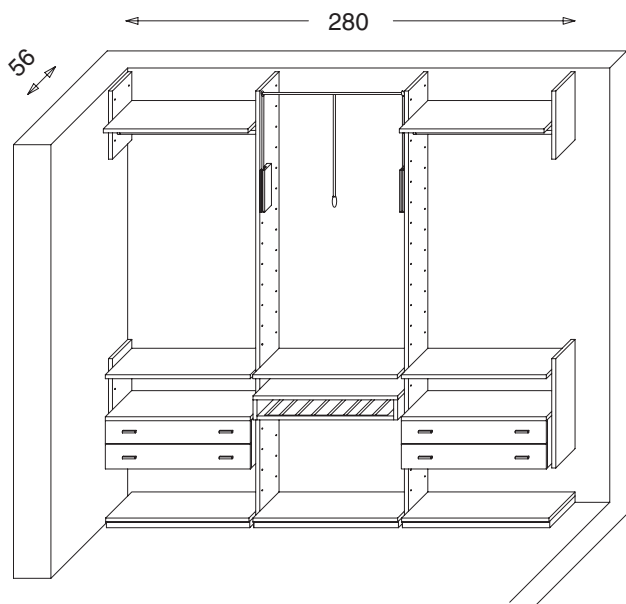

AS103 3.487

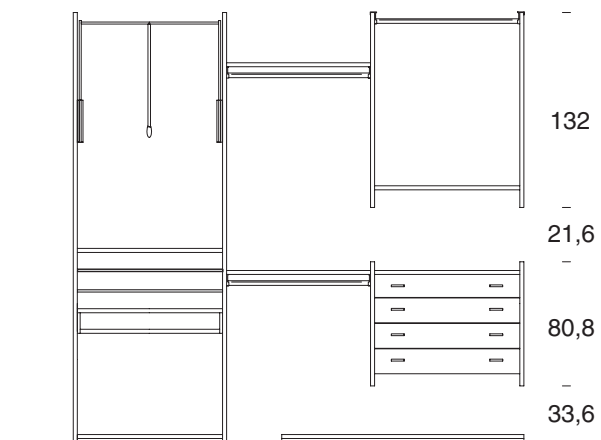
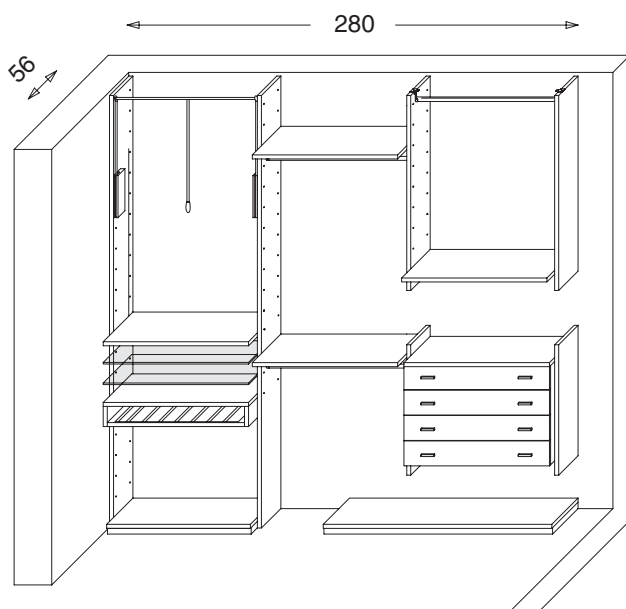

AS104 3.459

## Vista assonometrica

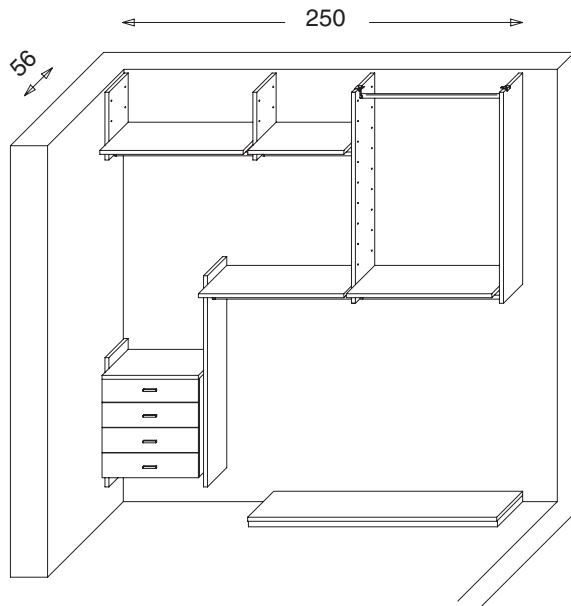

## Schema quotato

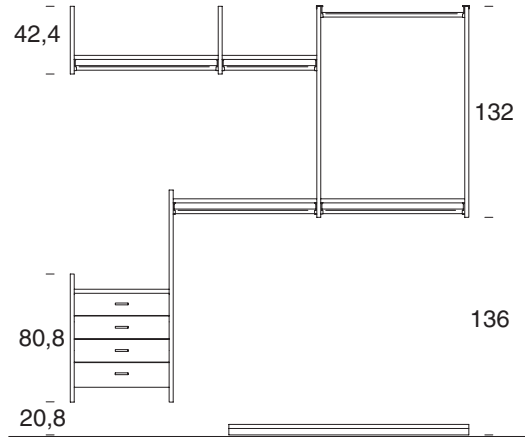

AS105 2.298

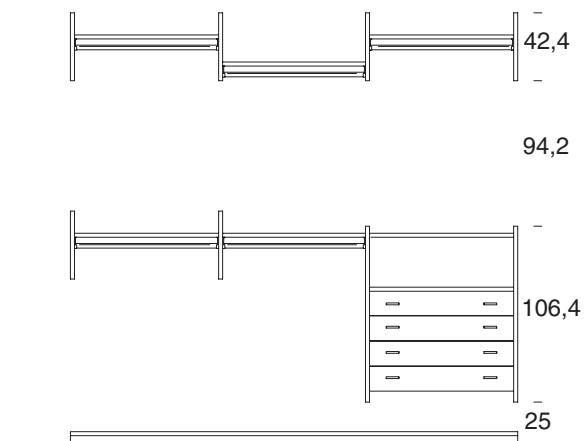
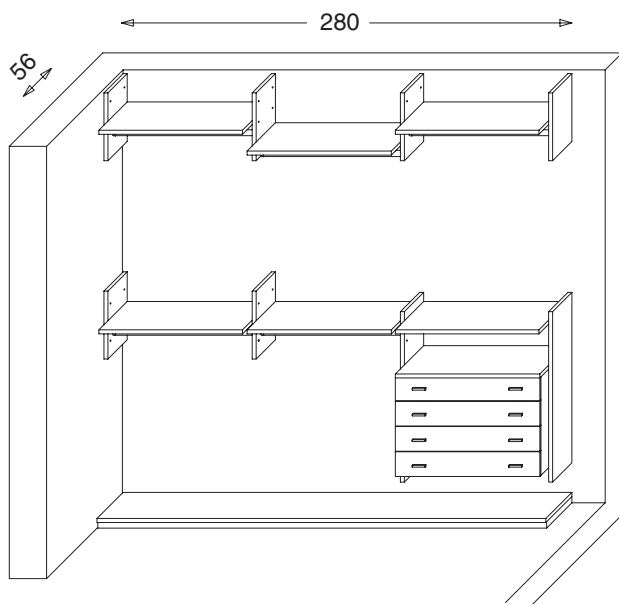

AS106 2.831

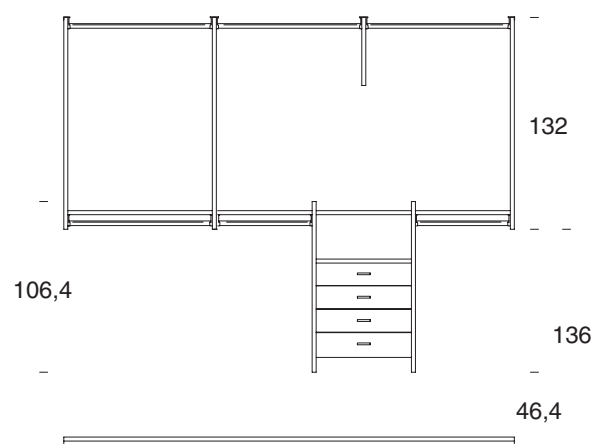
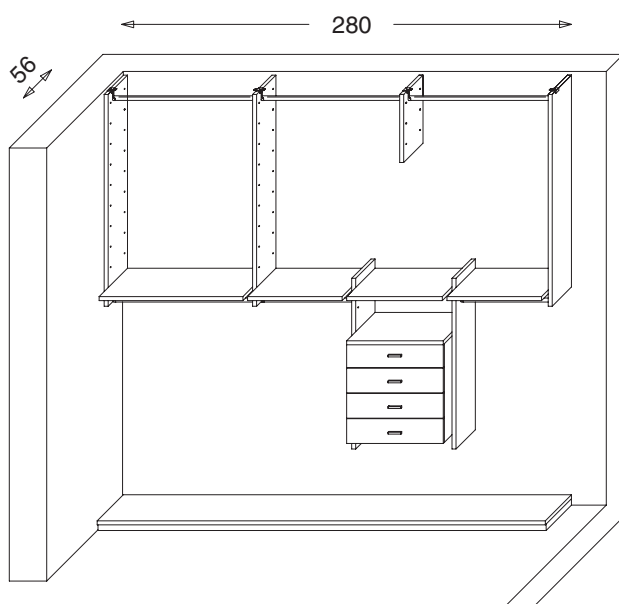

AS107 2.489



## CREMA

La cabina armadio CREMA è un sistema alternativo al solito armadio.

La cabina armadio CREMA è costituita da cremagliere regolabili sui 3 assi, pannelli sp. cm. 1,8, attrezzati con ripiani e canne appendiabiti, fissati tramite supporti con innesto.

Completano il programma una serie di cassettiere e accessori vari.

### CREMA CON PANNELLI

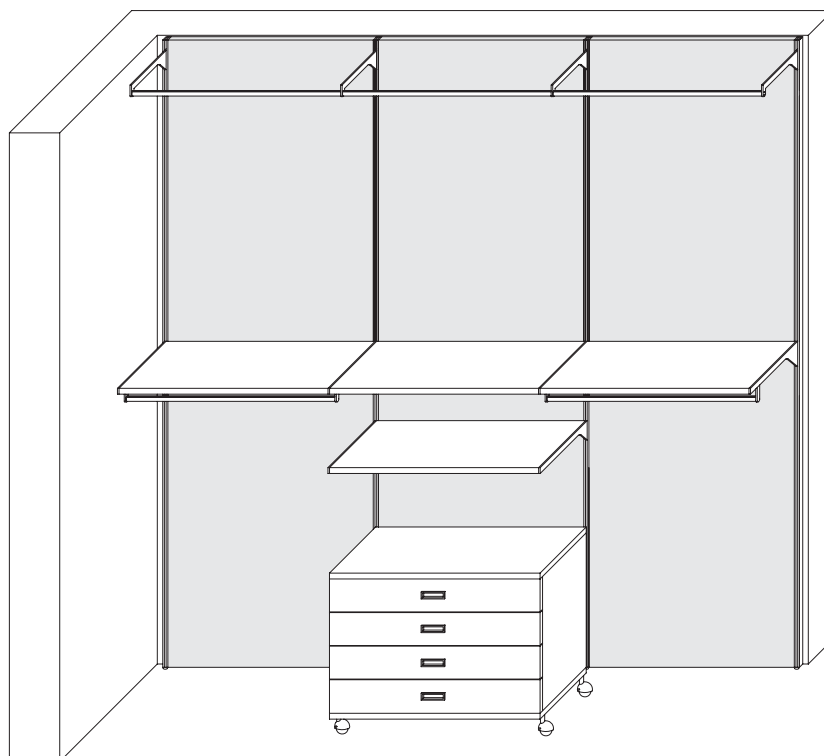

### CREMA SENZA PANNELLI

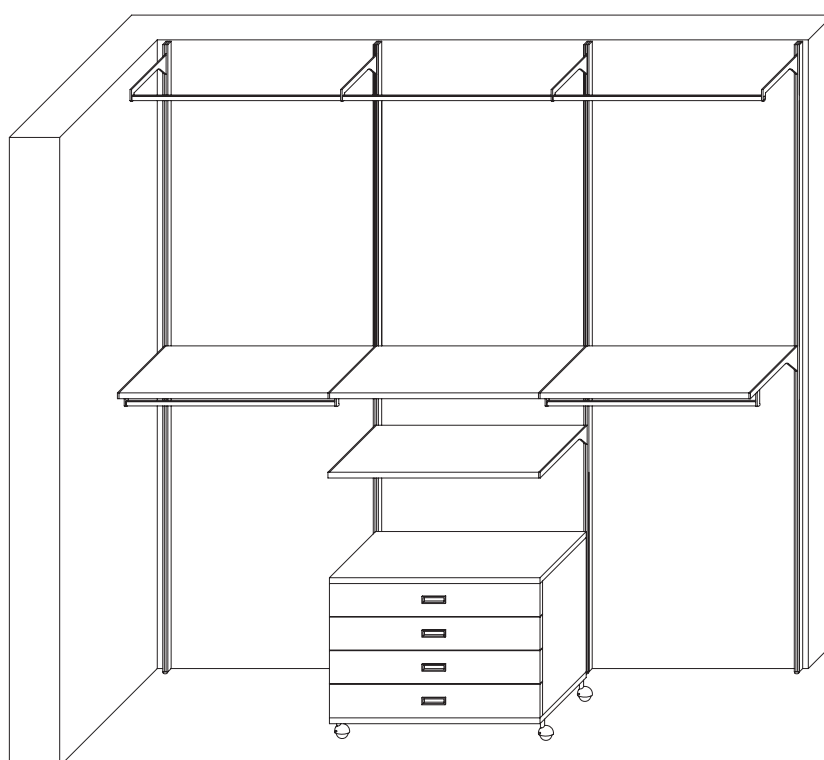

#### FINITURE

- Nobilitato bianco
- Nobilitato grigio tessuto
- Nobilitato canapa tessuto
- Nobilitato larice bianco
- Nobilitato larice termo
- Nobilitato olmo urbano

A richiesta, la struttura e le attrezzature interne possono essere fornite in finitura laccato opaco scala RAL, NCS, al campione.

Contattare il Ns. Ufficio Tecnico per specifiche tecniche e preventivi.

**Tutte le attrezzature e i componenti in metallo sono verniciati color grigio alluminio.**

# CREMA

Cremagliera in alluminio H. fino a cm. 297.  
Per facilitare il montaggio e per ovviare alle imperfezioni delle pareti e del pavimento, è possibile effettuare una regolazione delle cremagliere sui tre assi.

Nel foro della cremagliera L. mm. 7 è possibile inserire un solo supporto in alluminio sp. mm. 4, che può essere iniziale o terminale con le congiunzioni su un lato, centrale con le congiunzioni sui due lati.

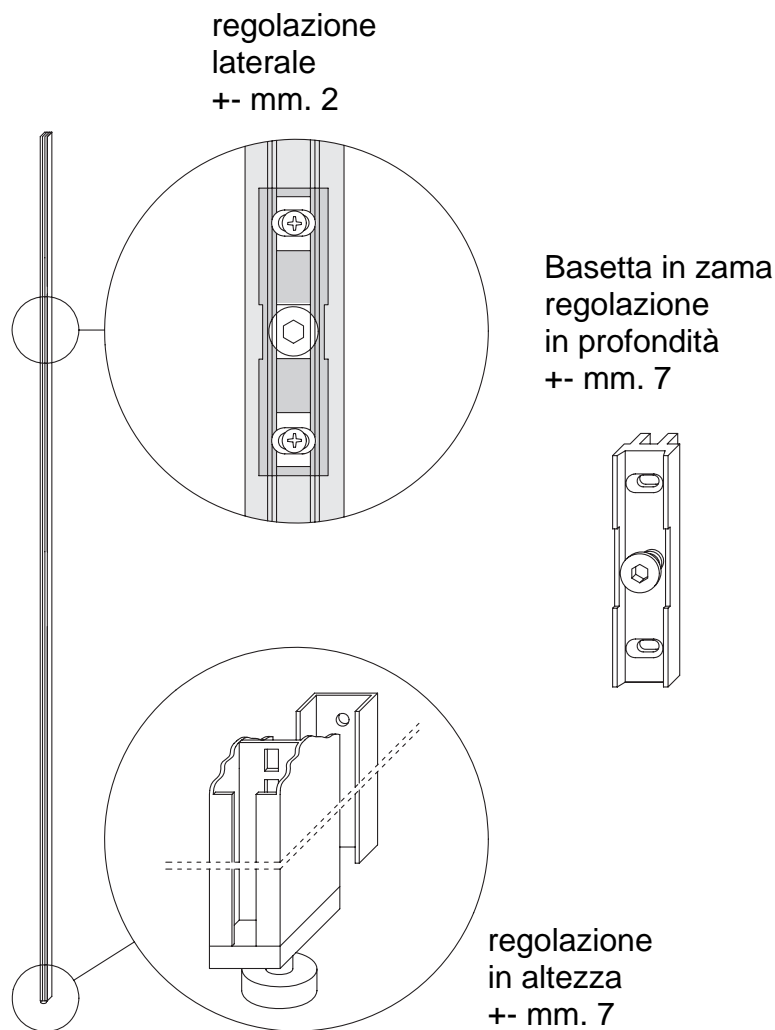

Supporto iniziale e terminale

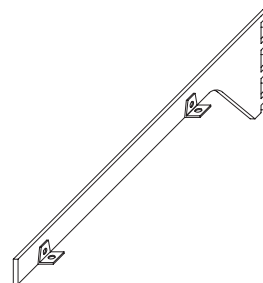

Supporto centrale

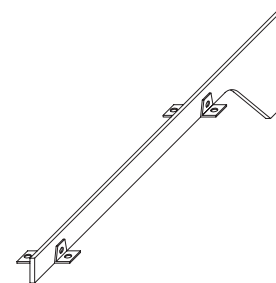

Pannelli sp. cm. 1,8

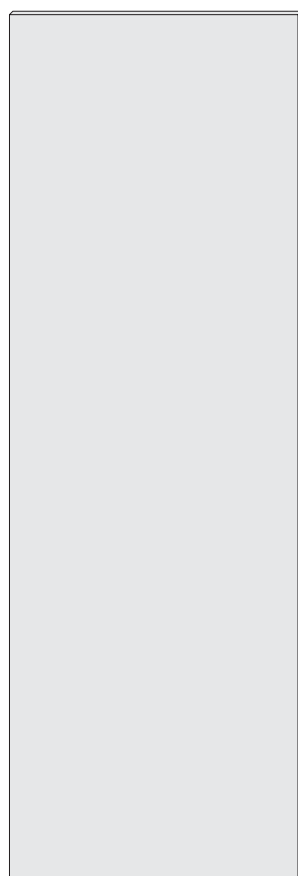

**Larghezza**

- fino a L. cm. 43
- da L. cm. 43,1 a 58
- da L. cm. 58,1 a 88
- Angolare: L. cm. 106,85

**Altezza**

- fino a H. cm. 240
- da H. cm. 241 a 270
- da H. cm. 271 a 297

Ripiani sp. cm. 2,5  
prof. cm. 56,2



**Misure standard**

- L. cm. 45
- L. cm. 60
- L. cm. 90
- Angolare: L. cm. 110 x 110

**Larghezza**

- fino a L. cm. 45
- da L. cm. 45,1 a 60
- da L. cm. 60,1 a 90

Per permettere la movimentazione delle cassettiere e delle attrezzature su ruote, occorre fare riferimento ai seguenti schemi:

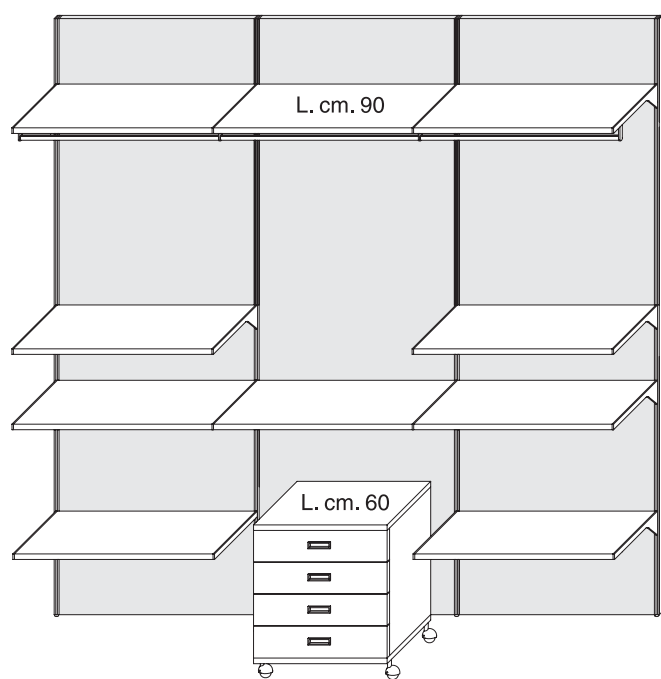
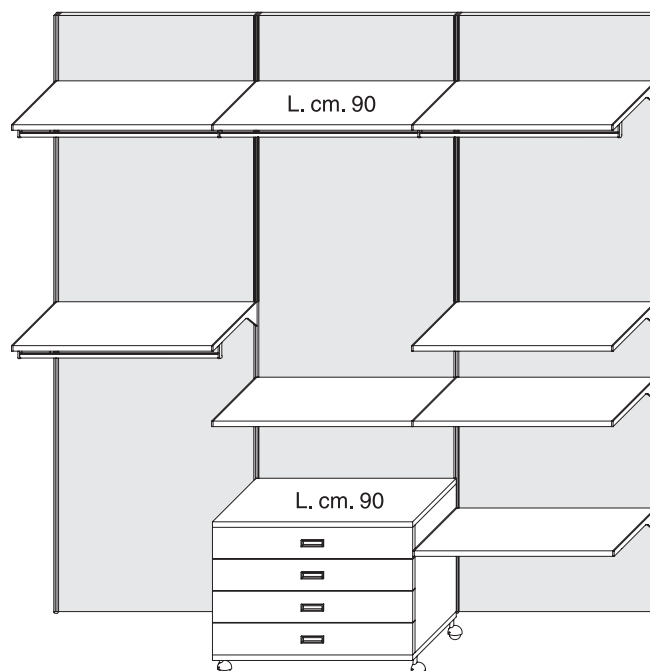
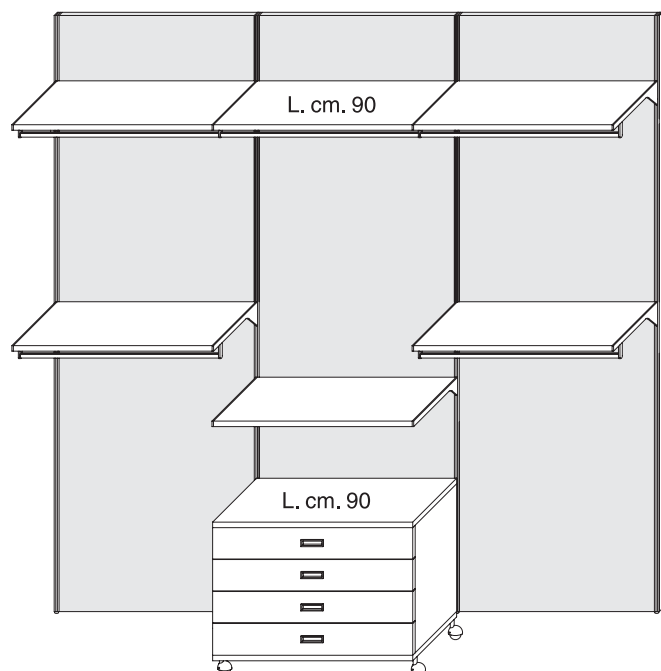

In questa composizione è stata inserita una cassetiera su ruote L. cm. 60, misura inferiore rispetto al ripiano L. cm. 90 della stessa colonna, in quanto i ripiani delle colonne laterali, posizionati ad un'altezza uguale o inferiore alla cassetiera, non permettono la movimentazione di una cassetiera su ruote L. cm. 90.



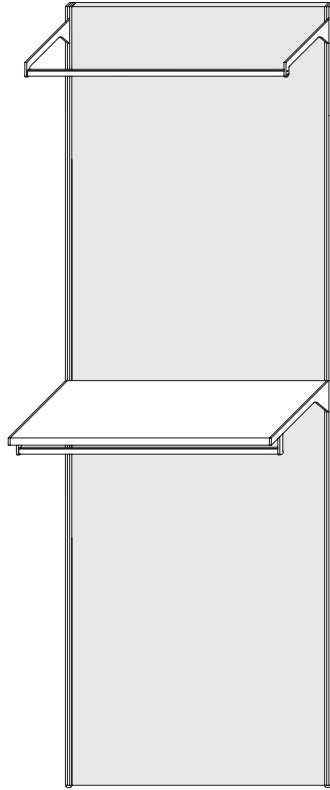

**VISTA ANTERIORE**

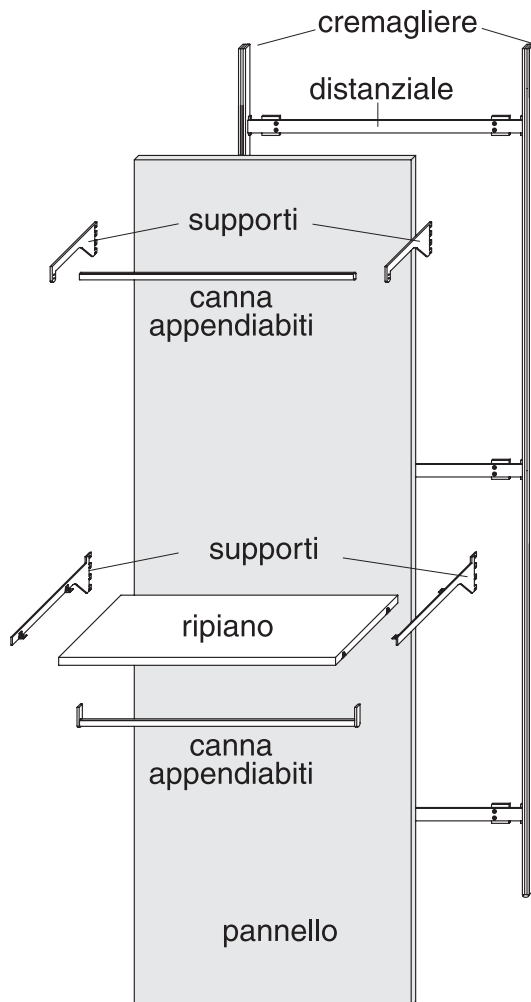

**VISTA POSTERIORE**

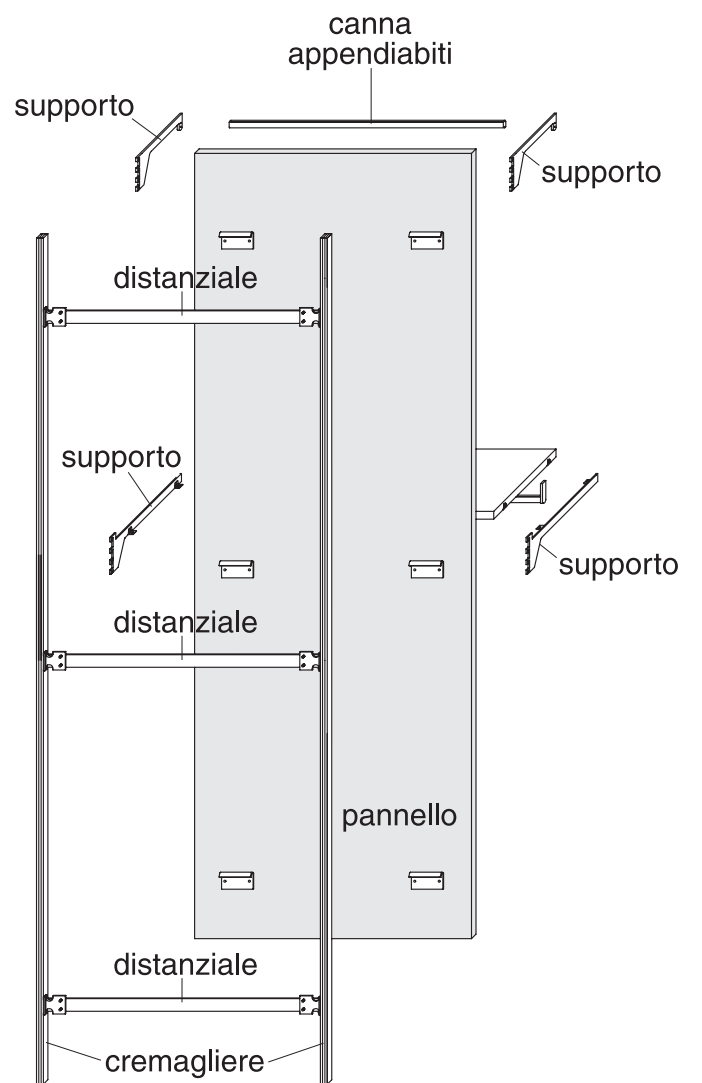

I pannelli vengono dotati di appositi attacchi, fissati posteriormente, che permettono l'aggancio ai distanziali delle cremagliere stesse.

## COMPOSIZIONI LINEARI

Per garantire il montaggio e la regolazione dei pannelli e delle cremagliere, occorre considerare una tolleranza minima di mm. 25 in altezza e mm. 40 in larghezza (mm. 20 per lato).

### ISTRUZIONI PER CALCOLARE CORRETTAMENTE LE MISURE IN LARGHEZZA

#### ESEMPIO DI PARETE L. mm. 2640

Se non espressamente indicato nell'ordine, i ripiani vengono forniti considerando la larghezza standard, riducendo un solo modulo.

$$\text{mm. } 20 + 9,25 + 4 + 900 + 4 + 765 + 4 + 900 + 4 + 9,25 + 20 = 2640$$

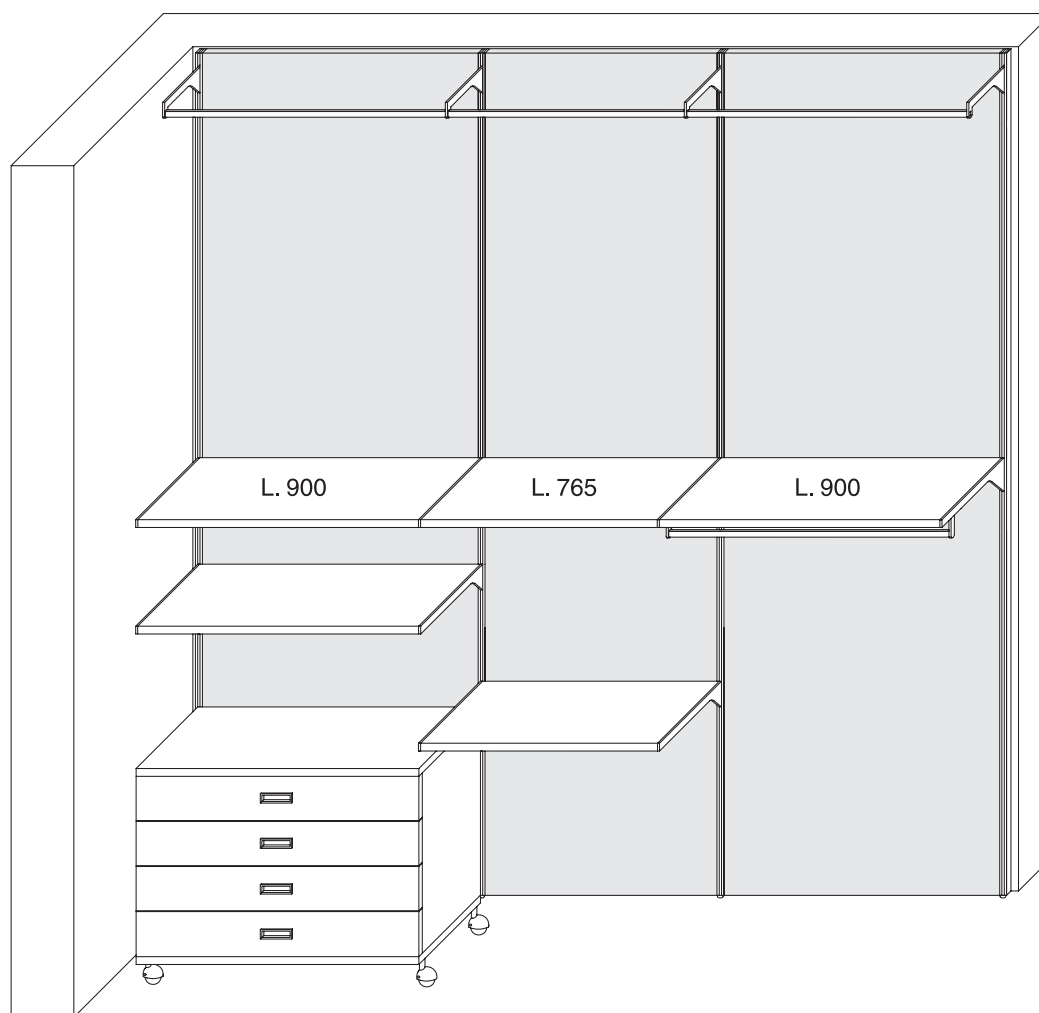
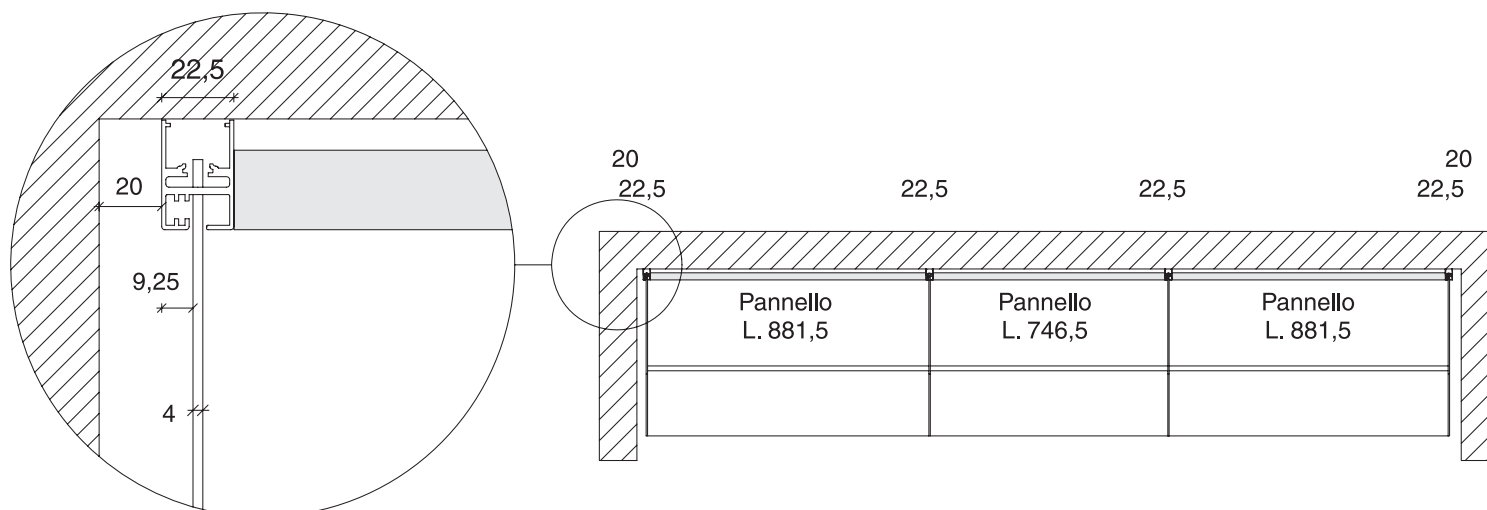

## COMPOSIZIONI LINEARI

Per garantire il montaggio e la regolazione delle cremagliere, occorre considerare una tolleranza minima di mm. 25 in altezza e mm. 40 in larghezza (mm. 20 per lato).

### ISTRUZIONI PER CALCOLARE CORRETTAMENTE LE MISURE IN LARGHEZZA

#### ESEMPIO DI PARETE L. mm. 2640

Se non espressamente indicato nell'ordine, i ripiani vengono forniti considerando la larghezza standard, riducendo un solo modulo.

$$\text{mm. } 20 + 9,25 + 4 + 900 + 4 + 765 + 4 + 900 + 4 + 9,25 + 20 = 2640$$

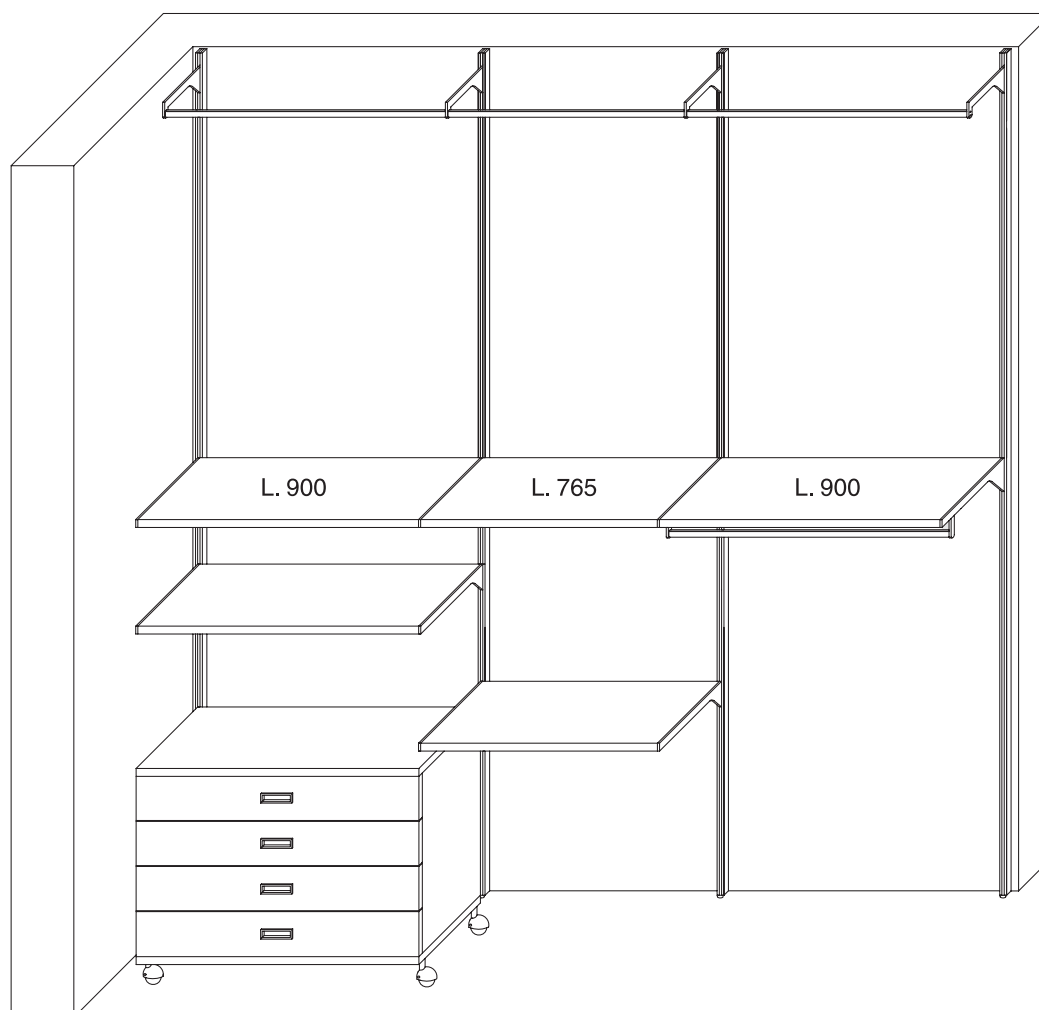
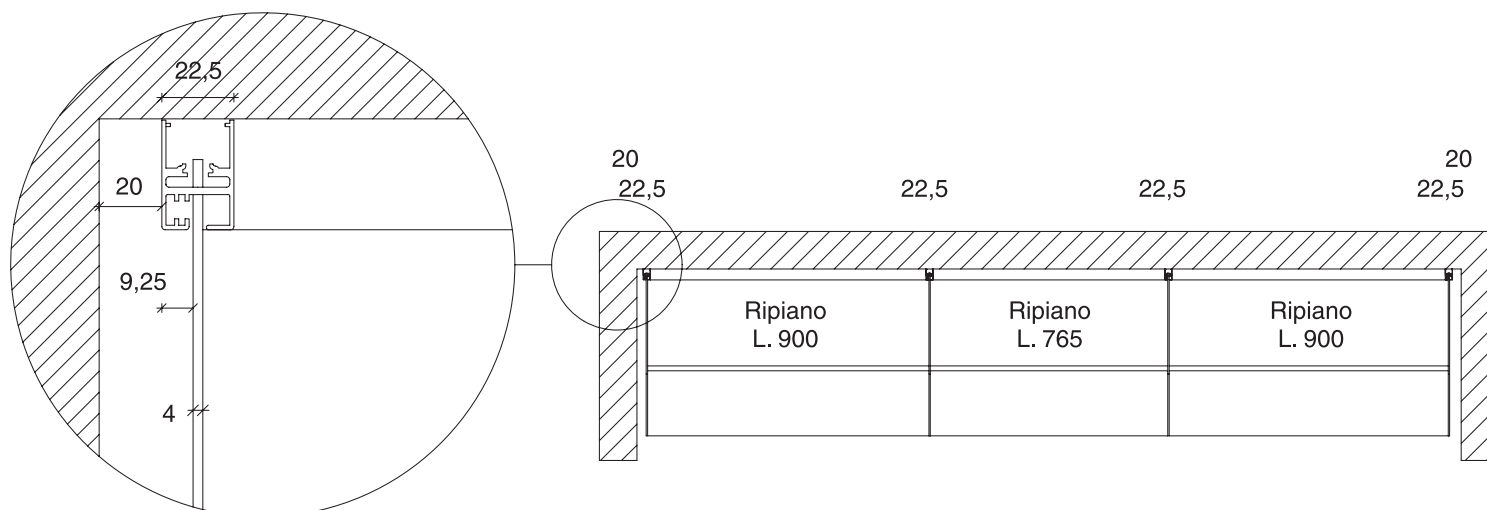

## COMPOSIZIONI ANGOLARI

Per garantire il montaggio e la regolazione delle cremagliere, occorre considerare una tolleranza minima di mm. 25 in altezza.

In larghezza occorre considerare lo spessore della cremagliera di mm. 35, oltre allo spazio tecnico di mm. 30 per ogni parete.

### ISTRUZIONI PER CALCOLARE CORRETTAMENTE LE MISURE IN LARGHEZZA

ESEMPIO DI PARETE L. mm. 1850 x 2800

PARETE A: mm.  $30 + 9,25 + 4 + 670 + 4 + 1100 + 35 = 1850$

PARETE B: mm.  $35 + 1100 + 4 + 900 + 4 + 715 + 4 + 9,25 + 30 = 2800$

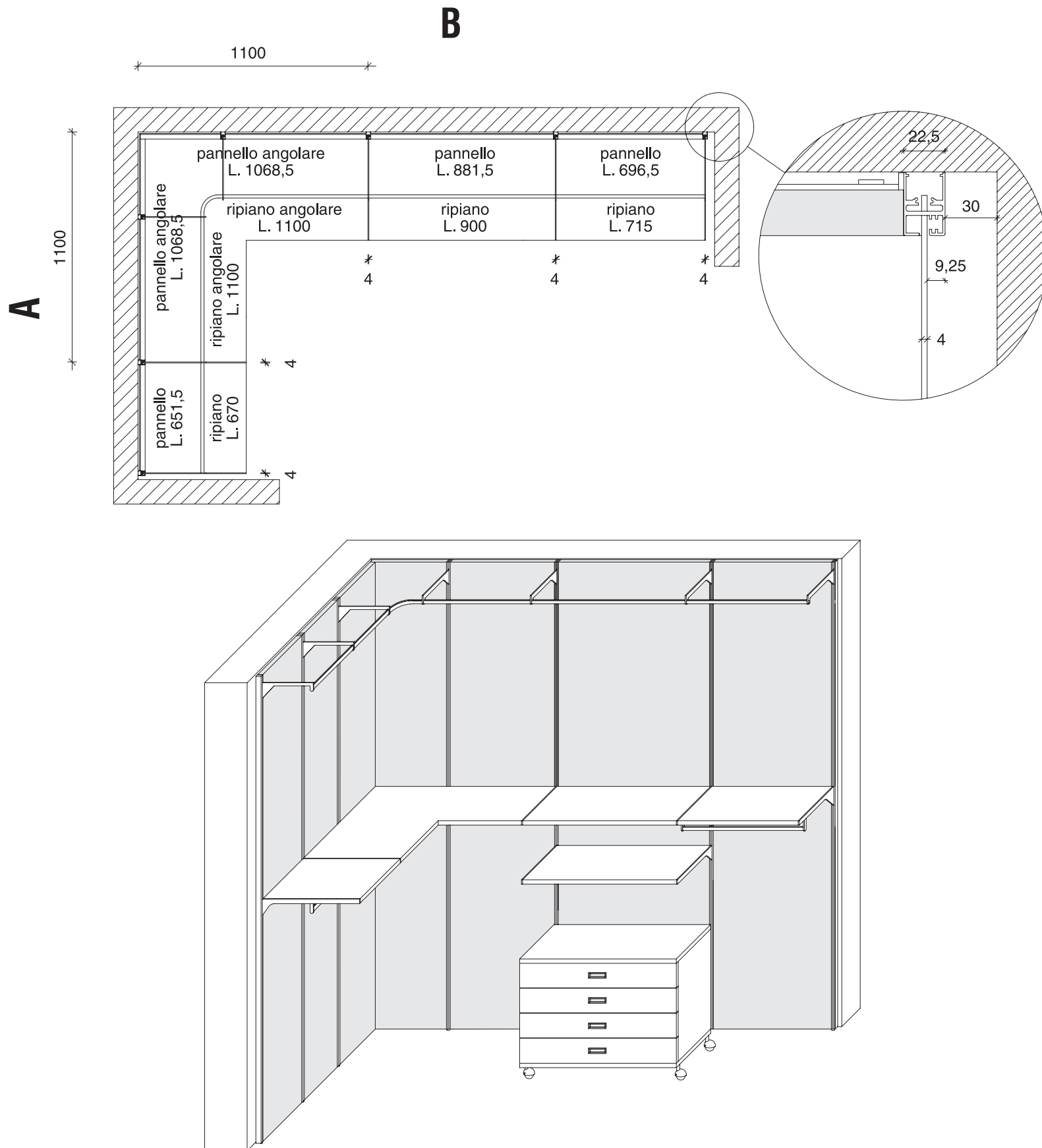

Le cremagliere poste nell'angolo sono indispensabili per sorreggere le attrezzature angolari (cane appendiabiti e ripiani)

## COMPOSIZIONI ANGOLARI

Per garantire il montaggio e la regolazione delle cremagliere, occorre considerare una tolleranza minima di mm. 25 in altezza.

In larghezza occorre considerare lo spessore della cremagliera di mm. 35, oltre allo spazio tecnico di mm. 30 per ogni parete.

### ISTRUZIONI PER CALCOLARE CORRETTAMENTE LE MISURE IN LARGHEZZA

ESEMPIO DI PARETE L. mm. 1850 x 2800

PARETE A: mm.  $30 + 9,25 + 4 + 670 + 4 + 1100 + 35 = 1850$

PARETE B: mm.  $35 + 1100 + 4 + 900 + 4 + 715 + 4 + 9,25 + 30 = 2800$

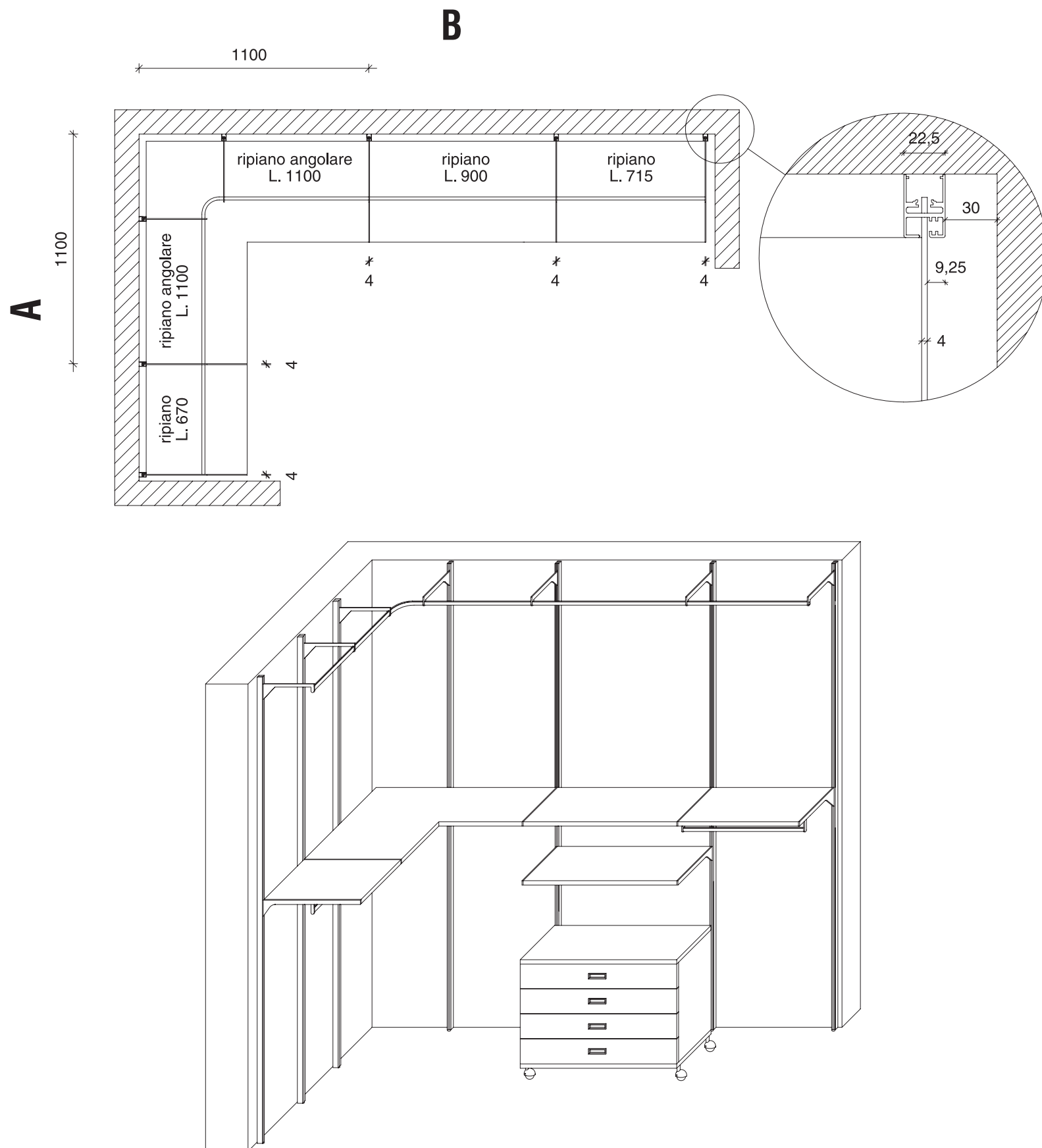

Le cremagliere poste nell'angolo sono indispensabili per sorreggere le attrezzature angolari (canne appendiabiti e ripiani)

# CREMA

## CREMAGLIERE IN ALLUMINIO

Non è possibile ricavare da un'unica cremagliera due o più cremagliere.

fino a H. cm. 240

da H. cm. 241 a 270

da H. cm. 271 a 297



CR1	287	CR2	302	CR3	316
-----	-----	-----	-----	-----	-----

## SUPPORTI

supporto per ripiano  
P. cm. 56,2

supporto esclusivamente per canna  
appendiabiti posizionata a filo soffitto  
P. cm. 29

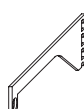
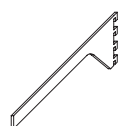

CR4	47	CR5	36
-----	----	-----	----

## CANNE APPENDIABITI

fino a L. cm. 45

da L. cm. 45,1 a 60

da L. cm. 60,1 a 90

L. cm. 82 x 82  
con 2 supporti  
con foro ovale cm. 3 x 1,5

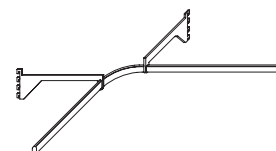

CR6	19	CR7	20	CR8	21	CR9	187
-----	----	-----	----	-----	----	-----	-----

# CREMA

## APPENDIABITI SALISCENDI - portata max. Kg. 10 completi di 4 supporti

fino a L. cm. 45

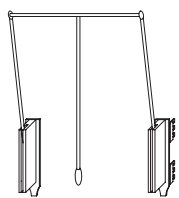

da L. cm. 45,1 a 60

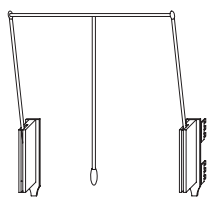

da L. cm. 60,1 a 90

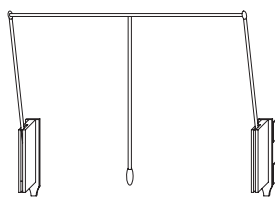

CR10 316

CR11 316

CR12 316

## RIPIANI sp. cm. 2,5 prof. cm. 56,2

fino a L. cm. 45

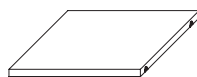

da L. cm. 45,1 a 60

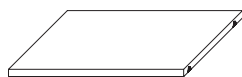

da L. cm. 60,1 a 90

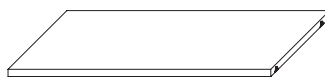

L. cm. 110 x 110  
con 2 supporti

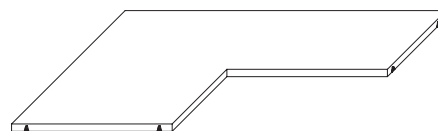

CR13 51

CR14 54

CR15 61

CR16 197

## RIPIANI sp. cm. 2,5 prof. cm. 56,2 con canna appendiabiti

fino a L. cm. 45

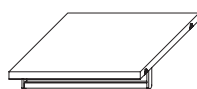

da L. cm. 45,1 a 60



da L. cm. 60,1 a 90



L. cm. 110 x 110  
con 2 supporti

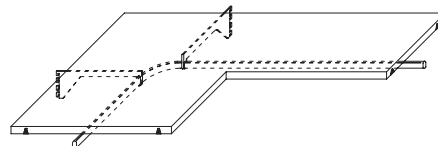

CR17 67

CR18 73

CR19 80

CR20 251

## PORTAPANTALONI prof. cm. 56,2 ad estrazione totale con BLUMOTION

L. cm. 90

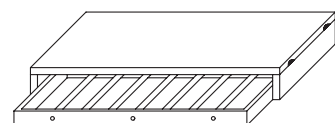

CR21 302

## CASSETTIERE SOSPESSE

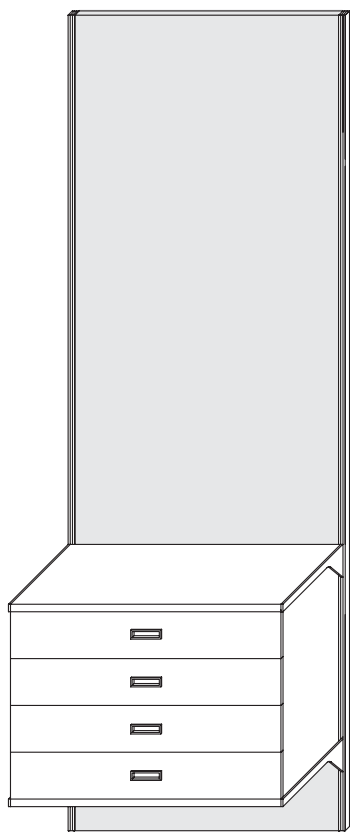

Per il montaggio delle cassettiere sospese occorrono 4 supporti

### CASSETTIERE SOSPESSE ad estrazione totale con BLUMOTION H. cm. 34,5 P. cm. 56,2

L. cm. 45

L. cm. 60

L. cm. 90

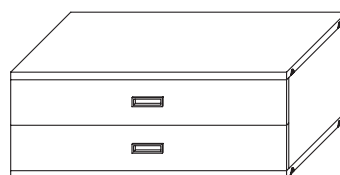

CR22	431	CR23	461	CR24	486
------	-----	------	-----	------	-----

### CASSETTIERE SOSPESSE ad estrazione totale con BLUMOTION H. cm. 66,5 P. cm. 56,2

L. cm. 45

L. cm. 60

L. cm. 90

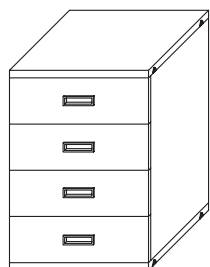

CR25	667	CR26	711	CR27	753
------	-----	------	-----	------	-----



## PANCHE sp. cm. 2,5 prof. cm. 56,2 con ZOCCOLO IN ALLUMINIO H. cm. 4

fino a L. cm. 45

da L. cm. 45,1 a 60

da L. cm. 60,1 a 90

da L. cm. 90,1 a 150

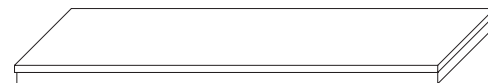
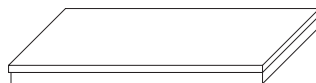
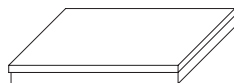
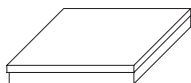

<b>CR28</b>	<b>123</b>	<b>CR29</b>	<b>137</b>	<b>CR30</b>	<b>152</b>	<b>CR31</b>	<b>221</b>
-------------	------------	-------------	------------	-------------	------------	-------------	------------

da L. cm. 150,1 a 200

da L. cm. 200,1 a 250

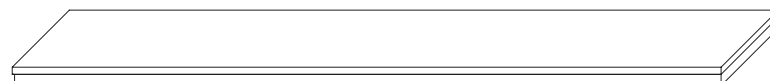
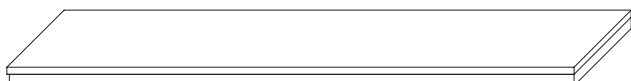

<b>CR32</b>	<b>265</b>	<b>CR33</b>	<b>332</b>
-------------	------------	-------------	------------

da L. cm. 250,1 a 300

L. cm. 110 x 110

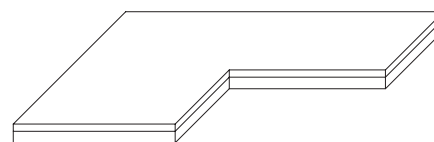
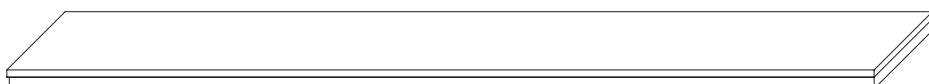

<b>CR34</b>	<b>376</b>	<b>CR35</b>	<b>332</b>
-------------	------------	-------------	------------

## CREMA

### CASSETTIERE SU RUOTE ad estrazione totale con BLUMOTION H. cm. 42,5 P. cm. 56,2

L. cm. 45

L. cm. 60

L. cm. 90

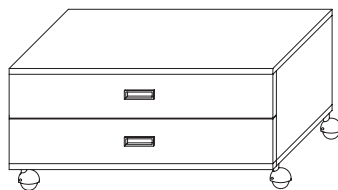
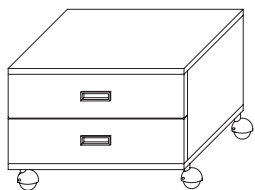
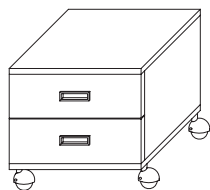

CR36	452	CR37	483	CR38	509
------	-----	------	-----	------	-----

### CASSETTIERE SU RUOTE ad estrazione totale con BLUMOTION H. cm. 74,5 P. cm. 56,2

L. cm. 45

L. cm. 60

L. cm. 90

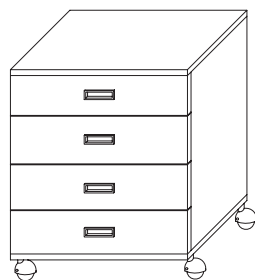

CR39	691	CR40	735	CR41	777
------	-----	------	-----	------	-----

### CASSETTIERE SU RUOTE ad estrazione totale con BLUMOTION H. cm. 96,5 P. cm. 56,2

L. cm. 45

L. cm. 60

L. cm. 90

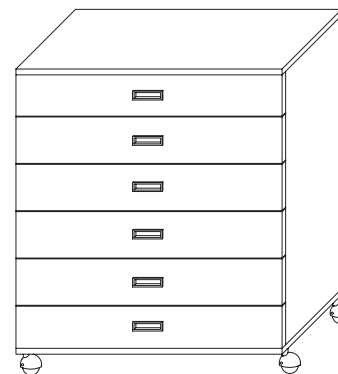
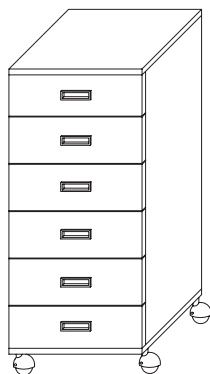

CR42	927	CR43	985	CR44	1.041
------	-----	------	-----	------	-------

### ELEMENTI SU RUOTE H. cm. 96,5 P. cm. 56,2

serrandina con 3  
ripianti in vetro  
L. cm. 90

alveare  
L. cm. 90

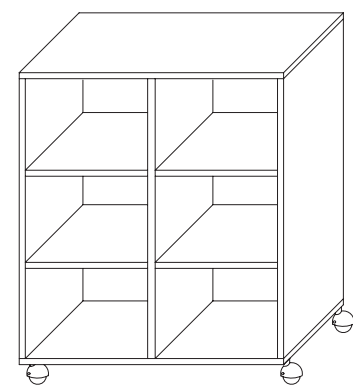
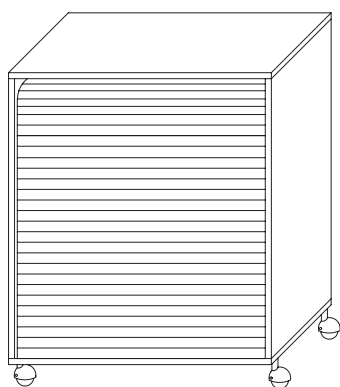

CR45	841	CR46	390
------	-----	------	-----

# CREMA

## PANNELLI sp. cm. 1,8

### ALTEZZA fino a cm. 240

fino a L. cm. 43

da L. cm. 43,1 a 58

da L. cm. 58,1 a L. 88

angolare L. cm. 106,85  
con cremagliera

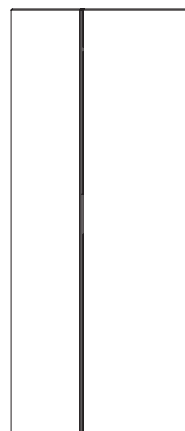

CR47	167	CR48	199	CR49	232	CR50	681
------	-----	------	-----	------	-----	------	-----

### ALTEZZA da cm. 241 a 270

fino a L. cm. 43

da L. cm. 43,1 a 58

da L. cm. 58,1 a L. 88

angolare L. cm. 106,85  
con cremagliera

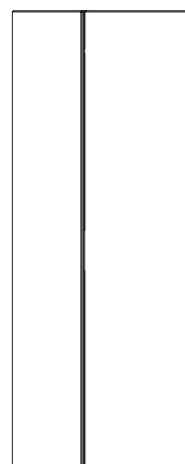
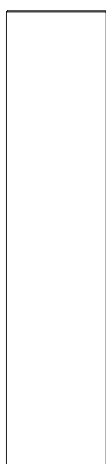

CR51	175	CR52	211	CR53	246	CR54	720
------	-----	------	-----	------	-----	------	-----

### ALTEZZA da cm. 271 a 297

fino a L. cm. 43

da L. cm. 43,1 a 58

da L. cm. 58,1 a L. 88

angolare L. cm. 106,85  
con cremagliera

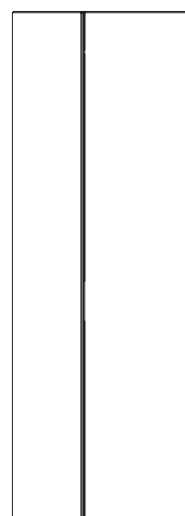
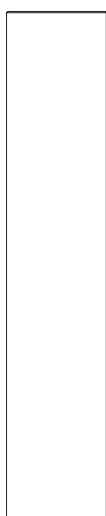

CR55	189	CR56	225	CR57	265	CR58	766
------	-----	------	-----	------	-----	------	-----

## ATTREZZATURE da fissare sul pannello o a parete con viti

pomolo appendiabiti



svuotatasche  
L. cm. 30 H. 10 P.15

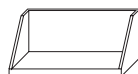

portacravatte  
L. cm. 50 H. 9



portacinture  
L. cm. 50 H. 9



<b>CR59</b>	<b>17</b>	<b>CR60</b>	<b>51</b>	<b>CR61</b>	<b>81</b>	<b>CR62</b>	<b>140</b>
-------------	-----------	-------------	-----------	-------------	-----------	-------------	------------

portagonne  
portapantaloni  
L. 50 - H. 9 - P. 20

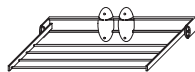

portascarpe estensibile  
in filo di ferro  
L. cm. 67/115 - P.20



Vaschetta per  
portascarpe  
estensibile  
(facoltativo)



portascarpe  
L. cm. 48 H. 70 P. 22

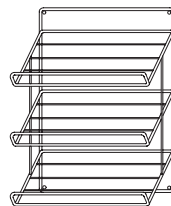

specchio  
L. cm. 36 H. 160



<b>CR63</b>	<b>148</b>	<b>CR64</b>	<b>47</b>	<b>CR65</b>	<b>70</b>	<b>CR66</b>	<b>84</b>	<b>CR67</b>	<b>94</b>
-------------	------------	-------------	-----------	-------------	-----------	-------------	-----------	-------------	-----------

## COMPOSIZIONI

Aggiungere cm. 2 per lato per composizioni lineari e cm. 3 per lato per composizioni angolari, necessari per il montaggio.

I prezzi si intendono riferiti a composizioni con cremagliere H. cm. 270

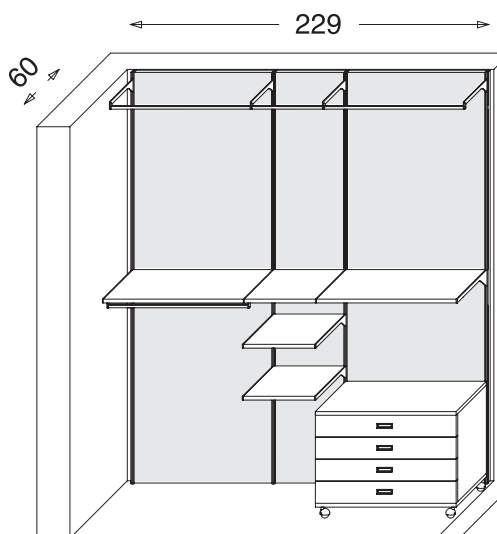
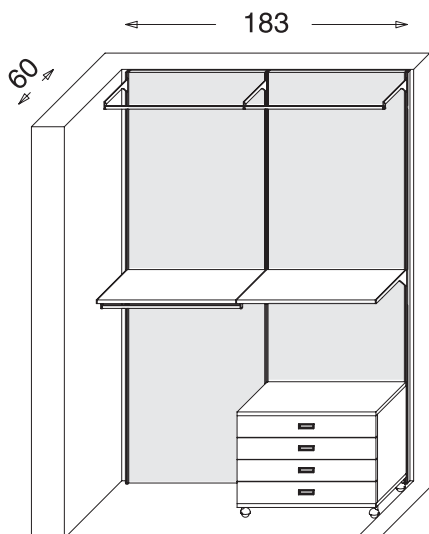

<b>CR68</b>	<b>2.098</b>		<b>CR70</b>	<b>2.823</b>	
<b>CR69</b>	<b>2.584</b>	con pannelli	<b>CR71</b>	<b>3.483</b>	con pannelli

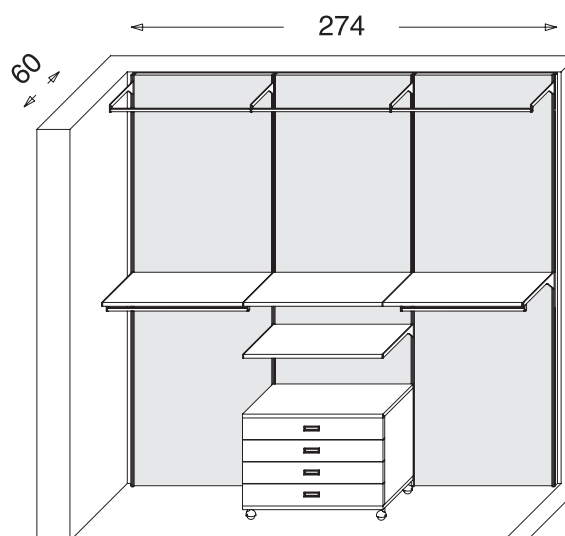
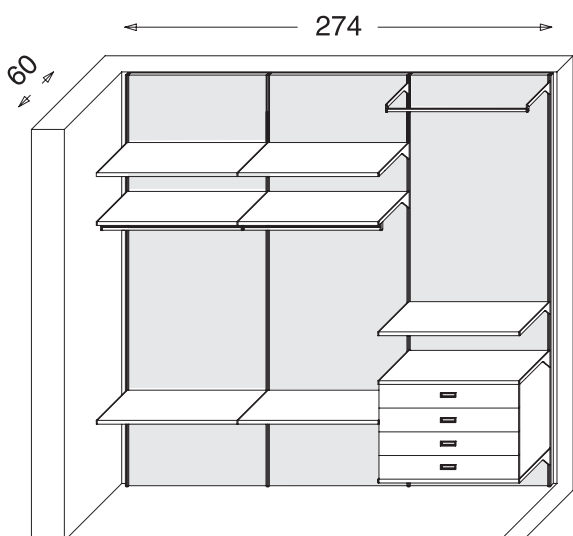

<b>CR72</b>	<b>3.178</b>		<b>CR74</b>	<b>2.725</b>	
<b>CR73</b>	<b>3.912</b>	con pannelli	<b>CR75</b>	<b>3.461</b>	con pannelli

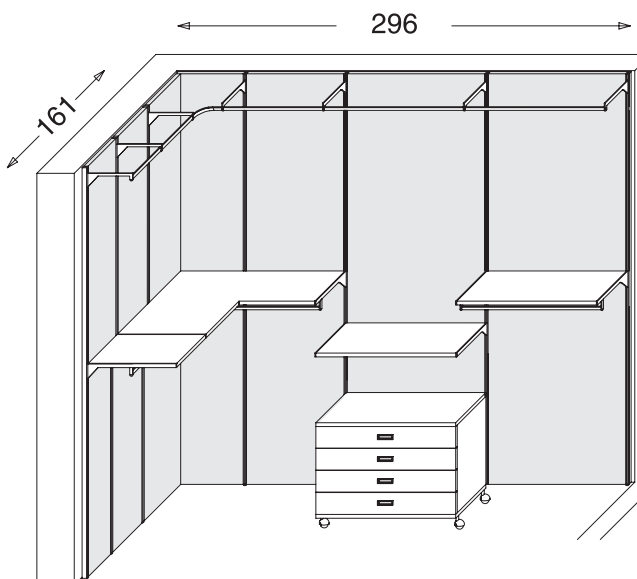
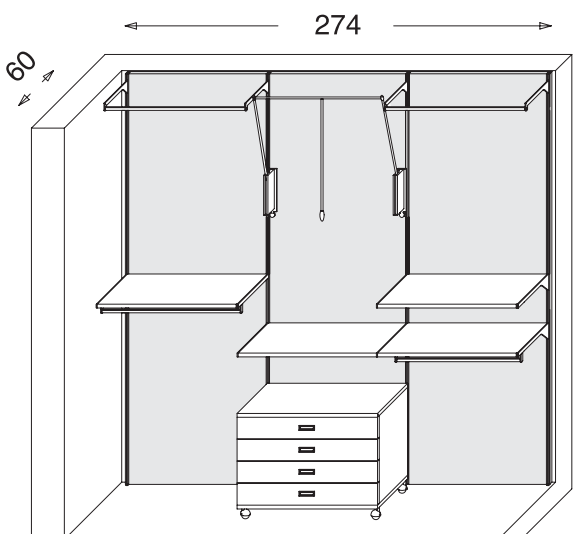

<b>CR76</b>	<b>3.066</b>		<b>CR78</b>	<b>4.065</b>	
<b>CR77</b>	<b>3.800</b>	con pannelli	<b>CR79</b>	<b>5.564</b>	con pannelli







ZEMMA s.r.l.

Industria per l'arredamento  
Via Croce, 27 - 22060 Carugo - Como  
Telefono 031.745551 - Fax 031.750420  
[www.zemma.it](http://www.zemma.it) - [info@zemma.it](mailto:info@zemma.it)